



EUROPEAN COMMISSION
DIRECTORATE-GENERAL
CLIMATE ACTION

Directorate B - European and International Carbon Markets

Guidance Document No. 5

on the harmonised free allocation methodology for the
EU ETS post 2020

Guidance on Monitoring and Reporting in Relation to the Free Allocation Rules

Version issued on 22 February 2019

The guidance does not represent an official position of the Commission and is not legally binding. However, this guidance aims to clarify the requirements established in the EU ETS Directive and the FAR and is essential to understanding those legally binding rules.

Table of contents

1	INTRODUCTION	4
1.1	Scope of this guidance document	4
1.2	Where to find Guidance Documents	5
2	QUICK GUIDE TO M&R FOR ALLOCATION RULES	6
2.1	Where should I start reading?	6
2.2	What is new in Phase 4 regarding monitoring and reporting in the context of free allocation?	9
2.2.1	Relevant new elements of the Directive	9
2.2.2	New elements in the FAR	9
2.2.3	New elements on verification	11
2.3	Considerations for specific installation situations	11
2.3.1	Installations with low emissions.....	11
2.3.2	New entrants	12
2.3.3	Renunciation of free allocation	12
2.3.4	Mergers and splits	12
3	THE EU ETS COMPLIANCE CYCLE (OR: THE MRVA SYSTEM IN GENERAL)	13
4	CONCEPTS AND APPROACHES	15
4.1	What are benchmarks and sub-installations in the EU ETS?	15
4.2	What are “inputs, outputs and emissions” of a sub-installation?	16
4.3	Attributed emissions.....	23
4.4	Further rules on splitting data into sub-installations.....	23
4.5	Example for splitting an installation into sub-installations	24
4.6	Terms used in the MRR and AVR (emissions monitoring)	31
4.7	Terms introduced by the FAR important for monitoring	34
5	THE MMP	38
5.1	The MMP content	38
5.2	Developing the MMP	39
5.3	Approval of the MMP.....	42
5.3.1	Timing	42
5.3.2	Different focus of MMP in the first NIMs round and thereafter.....	43
5.3.3	Verification without approved MMP	45
5.4	The improvement principle – approval of MMP updates	45
5.5	The control system.....	47
5.6	Avoiding and closing data gaps.....	47
5.6.1	Temporary deviations from the approved MMP	47

5.6.2	Missing data.....	48
5.6.3	Conservative approaches	49
6	MONITORING RULES	50
6.1	Overview of FAR monitoring rules.....	50
6.2	Overarching principles	51
6.3	Installation level data and split to sub-installations	52
6.3.1	Use of sub-meters	52
6.3.2	Split into sub-installation without direct metering.....	55
6.4	Direct vs. indirect data determination	56
6.5	Examples of indirect determination methods and correlations	57
6.6	Selecting the most accurate data source.....	59
6.6.1	Hierarchy of data sources.....	60
6.6.2	Technical feasibility and unreasonable costs	64
6.6.3	Simplified uncertainty assessment.....	66
6.7	Handling of units used by several sub-installations.....	67
6.8	Monitoring of production levels	68
6.9	Monitoring of measurable heat.....	69
6.10	Rules on CHP.....	70
6.11	Rules on cross-boundary heat flows	71
6.12	Detailed heat balance	71
6.13	Determining the boundaries of the fuel BM sub-installations	74
6.14	Determining the boundaries of the process emissions sub-installations.....	75
6.15	Rules for Waste gases	77
6.16	Monitoring of electricity	77
7	ANNEX A – CENTRAL CONCEPTS.....	79
7.1	What are benchmarks and sub-installations in the EU ETS?	79
7.2	Product benchmarks and “fall-back” sub-installations	82
7.3	Attributed emissions.....	83
7.3.1	Examples: General introduction.....	88
7.3.2	Examples: Fuel and material input only (FM).....	89
7.3.3	Examples: Measurable heat flows (MH)	90
7.3.4	Examples: Waste gases (WG)	97
7.3.5	Examples: Electricity (Elec)	101
8	ANNEX B – ABBREVIATIONS.....	103

1 INTRODUCTION

1.1 Scope of this guidance document

This guidance document is part of a group of documents, which are intended to support Member States and their Competent Authorities throughout the Union in the consistent implementation of the allocation methodology for the fourth trading period of the EU ETS (post 2020). The methodology is established by the Commission Delegated Regulation adopted on 19 December 2018 on “Transitional Union-wide rules for harmonised free allocation of emission allowances pursuant to Article 10a of the EU ETS Directive” (the “Free allocation Rules”, FAR). Guidance Document 1 on General Guidance to the Allocation Methodology provides an overview of the legislative background to the group of guidance documents. It also explains how the different Guidance Documents relate to each other and provides in its Annex a glossary of important terminology used throughout all the guidance documents.

The current document covers the following main areas:

- First, a “quick guide” is provided for the reader new to the topic of free allocation in the fourth phase of the EU ETS (chapter 2);
- Chapter 3 gives an overview of the FAR-related (annual) “compliance cycle”, and chapter 4 introduces the essential concepts relevant for monitoring of data relevant for benchmarking in the EU ETS;
- The chapters 5 and 6 provide guidance on the monitoring and reporting requirements introduced by the FAR, and specifically requirements for the monitoring methodology plan (MMP);
- Annexes provide an in-depth discussion of the important concepts “sub-installation” and “attributed emissions”, as well as an overview of definitions, acronyms used and legislative texts.

Note on outstanding issues in this version of the Guidance Document

As decision-making on the allocation methodology is not yet finalized, certain elements of this Guidance Document are as yet undefined. This especially includes issues related to the implementing act still to be adopted on the detailed rules on the changes to allocations of free allowances and the update of the benchmark values. In addition, it can also apply to references to the outstanding legislation itself or to accompanying Guidance Documents that are still to be prepared or finalized.

1.2 Where to find Guidance Documents

All the Commission's guidance documents, FAQs and templates in relation to the free allocation rules can be found under:

https://ec.europa.eu/clima/policies/ets/allowances_en#tab-0-1

In addition, the Commission has provided an extensive suite of guidance material in relation to MRVA (Monitoring, Reporting, Verification and Accreditation) under the EU ETS¹. The user of the current document is assumed to be familiar with at least the basic principles of MRVA.

¹ https://ec.europa.eu/clima/policies/ets/monitoring_en#tab-0-1 – see in particular the section “Quick guides”

2 QUICK GUIDE TO M&R FOR ALLOCATION RULES

This chapter provides three tools for getting a quick overview to the rules on free allocation in the fourth EU ETS phase (2021-2030):

- Section 2.1 gives hints to different stakeholders (operators, verifiers, competent authority staff, national accreditation bodies) on which guidance documents provide them with the fastest way to learn the new concepts needed for free allocation in the EU ETS phase 4.
- Section 2.2 provides a quick overview of new elements in the legislation for phase 4, including more specific references to chapters of this guidance document.
- Section 2.3 provides brief additional information for operators of installations in certain situations (new entrants, installations which may be excluded from the EU ETS, renunciation of allocation, mergers and splits).

2.1 Where should I start reading?

The ideal entry point for reading about Monitoring, Reporting and Verification (MRV) in relation to the Free Allocation Rules (FAR) depends on your profession as well as your previous experience with the EU ETS. While this document is designed to be generally understandable without first reading other documents, it also attempts to avoid repetition from other documents as much as possible. Depending on your situation, the following apply:

- Operator of an installation, that has already provided data for free allocation in the third phase (2013-2020) of the EU ETS:
 - You will be interested in changes to the allocation methodology for the 4th phase. Start by reading section 2.2 of this document, before you decide which other sections are relevant for your installation.
 - As you will have to prepare a Monitoring Methodology Plan (MMP), don't miss chapter 5 of this document. Timelines and responsibilities are given in chapter 5.3.
 - Thereafter other documents in this series (as mentioned in section 1.2) should be consulted: For ensuring correct reporting of your baseline data, refer to guidance document (GD) number 3. For details on the new allocation process, an explanation is provided in Guidance 2, including how to split an installation into sub-installations.
 - For the MMP, you will have to understand the underlying monitoring rules and concepts. They are described in the present document, chapters 4 to 6.
 - Depending on your installation, you may be also be interested in rules for transfers of heat between installations (explained in GD 6), treatment of waste gases in the FAR (see GD 8), and GD 9 which explains in detail system boundaries and special data requirements for all product benchmarks.
- Operator of an installation that is new to the topic of free allocation in the EU ETS:
 - You are advised to start by reading GD 1 of this series (the source for these documents is given in section 1.2) on the overall allocation methodology, followed by GD 2 for learning about splitting an installation into sub-installations.

- Before you start preparing your installation’s monitoring methodology plan, you will also find GD 3 on the completion of the reporting template useful for understanding what kind of data will be required in the baseline report. For the latter process, continue reading the current document, in particular chapters 4 to 6.
- Depending on your installation, you may also be interested in rules for transfers of heat between installations (GD 6), treatment of waste gases in the FAR, and GD 9 which explains in detail system boundaries and special data requirements for all product benchmarks.
- Due to the relationship between annual emissions monitoring (in line with the MRR) and the monitoring required by the FAR you may also find it useful to get acquainted with the basic principles of the MRR. This is the purpose of the MRR “Quick guide for stationary installations” and MRR guidance document No. 1 “The MRR general guidance for installations”.
- Operator of an installation classified as an “electricity generator”, or installation for the purpose of capture, transport or geological storage of CO₂, which does not produce heat or other products eligible for free allocation:
 - In principle such installations are not eligible for free allocation under Article 10a of the Directive. However, for confirming this status the operator will find it useful to get in touch with the responsible Competent Authority (CA). Some CAs may still require the operator to confirm this situation, e.g. by submitting an (empty) baseline report (no verification necessary). Reading any of the FAR related guidance documents is optional. The Commission’s guidance on the identification of electricity generators² is useful.
 - If the installation is situated in one of the Member States eligible for granting support under Article 10c of the EU ETS Directive (“Option for transitional free allocation for the modernisation of the energy sector”), it is advisable to get in touch with the CA responsible for the implementation of that Article.
- Operator of an installation that intends to renounce its free allocation:
 - Section 2.3.3 of this document should help to understand the consequences of renunciation of free allocation, as well as related roles, responsibilities and timelines.
 - If after reading that section you come to the conclusion, that you still want to apply for free allocation for your installation, please go ahead as described above for other operators.
- Operator of a new entrant:
 - A new entrant is an installation which has received its greenhouse gas emissions permit (i.e. the permit issued in accordance with Articles 5 and 6 of the EU ETS Directive) after 30 June 2019 or 30 June 2024, respectively. While the requirements on monitoring methodology plans and providing data needed for allocation to the CA are similar and based on the same principles of the FAR, the timing of submissions will be different.
 - Please refer first to section 2.3.2 of this document, as well as to guidance document No. 7 (“Guidance on new entrants and closures”), before continuing as advised for “Operator of an installation, who is new to the topic of free allocation” above.

² https://ec.europa.eu/clima/sites/clima/files/ets/docs/guidance_electricity_generators_en.pdf

- Aircraft operator: Free allocation to aircraft operators is not subject of Article 10a of the EU ETS Directive. Please refer to the MRR “Quick guide for aircraft operators”, and MRR guidance document No. 2 “General guidance for Aircraft Operators” for monitoring issues.
- Verifier:
 - Guidance document 4 specifically deals with verification of data required by the FAR.
 - Furthermore, for understanding of the requirements imposed on the operator, it is advisable to read the same documents suggested above for “operators new to the topic of free allocation in the EU ETS”.
 - As guidance document 4 advises, the general principles of EU ETS verification should be known to verifiers. For this purpose, refer to the guidance material provided for the AVR, in particular EGD I: “The Accreditation and Verification Regulation – Explanatory Guidance Document No.1”, or the AVR Quick Guide for Verifiers (for references see section 1.2).
- Competent authority with experience in the 3rd phase:
 - You will be interested in changes to the allocation methodology for the 4th phase. Start by reading section 2.2 of this document, before you read further sections of this document.
 - Thereafter other documents of this series (as listed in section 1.2) should be consulted.
- Competent authority staff new to the topic of free allocation:
 - You are advised to start by reading GD 1 of this series (the source for these documents is given in section 1.2) on the overall allocation methodology, followed by GD 2 to learn about splitting an installation into sub-installations.
 - You will also find GD 3 on the completion of the reporting template useful for understanding what kind of data will be required in the baseline report, as well as chapters 4 to 6 of the current document on requirements for installations’ monitoring methodology plans.
 - Further guidance documents in this series should be consulted on a case-by-case basis depending on the installations falling within your competence.
- National accreditation bodies (NABs):
 - The current document will provide you with an understanding of the different kinds of data the verifier has to handle as compared to the annual emissions data under EU ETS verification. This will provide you with a better understanding of GD 4 (verification of FAR data), which will be your primary information source when it comes to supervision of verifiers performing FAR data verification.
 - The general principles of EU ETS verification, however, can be learned from the guidance material provided for the AVR, in particular EGD I: “The Accreditation and Verification Regulation – Explanatory Guidance Document No.1”. There is also an AVR Quick Guide for NABs (for references see section 1.2).

2.2 What is new in Phase 4 regarding monitoring and reporting in the context of free allocation?

2.2.1 Relevant new elements of the Directive

Compared to the free allocation rules for phase 3, the following elements are new in the EU ETS Directive, and are reflected accordingly in the FAR:

- The length of EU ETS phase 4 is ten years (2021-2030), but allocation is calculated ex-ante for two separate “allocation periods” which are five years each (2021-2025 and 2026-2030). As basis for the allocation, “baseline data” has to be collected by Member States from operators. The respective “baseline periods” are 2014-2018 and 2019-2023, respectively, and are fixed in the Directive (Article 11(1)).
- The same Article ensures that free allocation can only be granted to operators who have submitted the relevant data (this submission is termed “**baseline data report**” in the FAR and in this guidance).
- The benchmark values will be updated (Article 10a(2)) every five years based on the same data collection, using years 2016-2017 and 2021-22 respectively. No change in the list of benchmarks is foreseen³. This has extensive impact on the data requirements, since the “attributed emissions at sub-installation level” are required to calculate a benchmark. This concept is explained in detail in sections 4.3 and 7.3 of this guidance.
- There will only be one list of sectors exposed to a significant risk of carbon leakage applicable for the full ten years of phase 4.
- The following new elements apply regarding changes to the free allocation throughout the allocation periods:
 - Only “greenfield plants” will be considered “new entrants” in line with a new definition provided by Article 3(h) of the Directive;
 - Activity Level Changes will trigger allocation changes – **detailed rules are yet to be developed (“ALC” Regulation)**;
 - Allocation changes will no longer be based on capacity changes – therefore there is no need to monitor and report capacity information.

2.2.2 New elements in the FAR

The following elements are new in the FAR compared to the CIMs of the third phase:

- Detailed rules for monitoring and reporting of all data required for free allocation and for the update of benchmark values are provided in the FAR Regulation, while in the third phase

³ By way of derogation regarding the benchmark values for aromatics, hydrogen and syngas, the EU ETS Directive requires that these benchmark values shall be adjusted by the same percentage as the refineries benchmark in order to preserve a level playing field for producers of those products. Hence baseline data gathered for aromatics, hydrogen and syngas sub-installations will not be employed to update benchmark values for these products. However, the FAR do not contain an exception for reporting the sub-installation attributed emissions and the underlying data for these product benchmarks.

these were available only in guidance documents. These rules include the following elements:

- Operators are required to have a “**monitoring methodology plan**” (MMP) as the basis for their monitoring. This follows the concept of the “methodology report” required in the third phase. It does not only cover the description of data sources used for historic data, but also provides the forward-looking approaches for actual monitoring of detailed data sets over time.

The MMP must be approved by the competent authority (CA), just like the monitoring plan (MP) under the Monitoring and Reporting Regulation (MRR) applicable for annual emissions. However, due to timing constraints it is acknowledged that such approval may not be possible in time for submission of the first baseline data report (in 2019). Therefore, unless the CA decides to require prior approval, the verifier will have to validate the MMP for the first submission of baseline data reports, similar to what was done with methodology reports for the third phase; this entails checking that it is in compliance with the FAR.

- The minimum content of the MMP is defined in Annex VI of the FAR. The Commission has published a template for the MMP.
- The FAR contain detailed rules for splitting installation into sub-installations (Article 10), on avoiding double counting and omissions, and on attributing emissions to sub-installations for the purpose of benchmark update (Annex VII section 10). Sections 4.3 and 7.3 of this document explain these rules.
- The FAR contain detailed rules for selecting *most accurate data sources*. Compared to the MRR this concept provides a kind of “tiers light”, with a hierarchy provided for selection of the data sources (section 4 of Annex VII of the FAR, explained in section 6.6 of this document). An uncertainty assessment is required only for providing a reason to deviate from the main hierarchy of approaches.
- Like in the MRR, a key element for ensuring data quality is that the operator has to implement a robust internal control system, which includes a risk assessment. Further information can be found in section 5.5.
- Similarly, continuous improvement of the MMP is required, but no improvement reports are envisaged (Article 9 on updating the MMP). Guidance is provided in section 5.5.
- For minimising data gaps, the FAR foresee that – to the extent feasible without incurring unreasonable costs – alternative data sources have to be listed in the MMP, alongside the main source based on most accurate data sources. The operator can thereby also ensure corroboration of the main data (see section 5.6).
- The minimum content of the baseline data report is given in Annex IV of the FAR. The Commission has provided a template for ensuring EU-wide harmonisation of these reports.
- The FAR require baseline data reports to be verified by an accredited verifier, complying with the (revised) Accreditation and Verification Regulation (AVR). For more details please see guidance document No. 4 on verification of FAR data.

- In order to receive free allocation, the operator has to submit an application for free allocation, by a specified deadline⁴ consisting of:
 - A baseline data report;
 - A verification report;
 - The MMP used for the above reports, unless it has already been approved by the CA.
- Application for free allocation is voluntary. Operators can furthermore renounce free allocation, e.g. if the administrative burden is perceived higher than the benefit from free allocation. The operator is obliged to monitor and report the data as outlined in this guidance only if he intends to apply for free allocation.
- The process of determining the free allocation has changed, in particular due to the update of benchmark values. Further details can be found in Guidance Document No.1.
- The general architecture of the rules to calculate free allocation based on product benchmarks, historic activity levels (HALs), fall-back approaches, and various correction factors, has remained largely unchanged.

2.2.3 New elements on verification

Detailed rules for verification and accreditation of verifiers have been developed for FAR data. These rules are included in the revised AVR. Guidance document 4 gives extensive details on the interpretation of those rules.

2.3 Considerations for specific installation situations

2.3.1 Installations with low emissions

If your installation falls into one of the categories covered by Articles 27 or 27a of the EU ETS Directive, your Member State may decide to exclude your installation from the EU ETS under certain conditions (in the case of Article 27, equivalent measures have to be applied for incentivising emission reductions).

If your Member State chooses this option, you have to get further guidance from your competent authority. However, you will have to continue monitoring of annual emissions as well as the data relevant for free allocation in order to be prepared for the situation that the installation exceeds the relevant thresholds for exclusion. You will also have to submit an MMP and baseline data report to your CA. However, the CA may put in place simplified requirements for this purpose⁵.

⁴ Article 5(1) of the FAR states “4 months before the deadline given in Article 11(1) of the EU ETS Directive” as a deadline (i.e. 31 May 2019 and 2024) as this deadline. However, Member States are given the option to move this deadline one month forward or backward.

⁵ In particular in case of exclusion pursuant to Article 27a(3), the MS may require monitoring of operating hours only.

2.3.2 New entrants

A “new entrant” is any installation carrying out one or more activities listed in Annex I of Directive 2003/87/EC which obtained a greenhouse gas emission permit after 30 June 2019 for the first allocation period, and after 30 June 2024 for the second allocation period in Phase 4. Therefore it means only greenfield plants⁶.

If you operate such an installation, all the rules described in this guidance document in principle apply to your installation from the start of operation, with a few differences, such as timing of the MMP submission. For details please see section 5.3.1.

2.3.3 Renunciation of free allocation

Operators can renounce free allocation, e.g. if the administrative burden of MRV is perceived to be higher than the benefit of free allocation. If the operator decides to renounce free allocation at some time during the allocation period, Article 24 of the FAR provides the basis to do so. The installation will not receive free allocation from the year following the application by the operator until the end of the allocation period. Consequently, also the need for monitoring of FAR-related data will end by the CA’s approval of the renunciation.

Note that there is no obligation for an operator to apply for free allocation at all by the deadline given by the FAR. If the operator chooses this route, there is no need to monitor FAR data, and consequently no need to develop an MMP.

However, if the operator decides to apply again for free allocation in a later allocation phase, he has to ensure that he has the relevant monitoring methodology in place in order to determine the required baseline data. For timing of the MMP submission please see section 5.3.1

2.3.4 Mergers and splits

If you operate an installation emerging from a merger or a split of other installations, you will have to ensure that the same data is reported as the former installations would have reported (i.e. the sum of previous activity levels must be identical to the sum of the later activity levels, etc.). This can usually be ensured by doing an analogous merger or split of the monitoring methodology plan, such that the methods of merging or splitting data sets are clearly described.

⁶ In the 3rd phase of the EU ETS, also significant capacity extensions were treated as new entrants.

3 THE EU ETS COMPLIANCE CYCLE (OR: THE MRVA SYSTEM IN GENERAL)

In the EU ETS, like in any carbon pricing system, Monitoring, Reporting and Verification (MRV) is of utmost importance for the smooth operation of the system. The competent authority (CA) is in charge of ensuring that the rules set out in legislation are complied with. As many activities in this regard are annually repeated, the term “(annual) compliance cycle” has been established. For the purposes of annual emissions MRV, MRR Guidance Document No. 1 (“General guidance for installations”, chapter 3) explains the roles, responsibilities and deadlines applicable in line with the MRR (Monitoring and Reporting Regulation) and AVR (Accreditation and Verification Regulation). The general architecture of that emissions compliance cycle also applies to MRV for the purpose of free allocation as set out by the FAR. For novice readers it is therefore recommended to consult MRR GD 1.

For FAR purposes some elements deviate from the general architecture:

- Firstly, a wider range of data sets is relevant than under the MRR. The additional data required, and how to monitor them, is the main topic of this document.
- The installation-specific monitoring methodology is laid down in the “monitoring methodology plan” (MMP), a document similar to the monitoring plan (MP) under the MRR (see chapter 5). Although some elements of the MP are also required for the MMP, it is at this stage not planned to integrate both documents into one, due to the different legal bases, and because it may be possible in some MS that different CAs are in charge of the MP and the MMP.
- The MP covers only monitoring *after* the MP has been approved. However, the MMP (at least before 2020) contains some “backward-looking” methodology elements (referring to “historical data”).
- Roles and responsibilities of operator, CA and verifier are very similar as for the MRR and AVR, with one important exception: Verification of the first baseline data report will require the verifiers to validate⁷ the MMP as being in compliance with the FAR for the relevant baseline period, unless the CA has already approved it prior to the first data submission (which is voluntary for MS).
- The compliance cycle under MRR and AVR are annual ones, while the FAR require reporting only every 5 years. Therefore, the rules regarding the improvement principle cannot make use of *annual* verifier’s comments, and the operator’s own initiative for improving the MMP will be more important. However, to limit administrative burden, no improvement reports are required under the FAR⁸.
- However, the FAR’s monitoring provisions will be beneficial for efficient setting up of the Activity Level Change (ALC) rules, which will require annual reporting of some (yet to be

⁷ See guidance document No. 4 of this series for more information on verification of FAR data.

⁸ The verifier will review implementation of improvement opportunities as part of subsequent verifications, and include related findings in the verification report. The CA will therefore be able to follow-up issues where the operator does not implement improvements.

defined) data which are also relevant for the FAR. In particular, the annual reporting of activity levels will be based on the same MMP as the baseline data report.

- The MMP should not be regarded as a static document but as a living document, that needs to be updated as relevant based on the operator's regular review (see section 5.4), just like the MP for emissions.

This guidance document will be updated as soon as there is clarity on annual reporting requirements under the Activity Level Change rules.

4 CONCEPTS AND APPROACHES

4.1 What are benchmarks and sub-installations in the EU ETS?

Benchmarks are a means to compare the performance of peers with a reference value, which is called the benchmark⁹. For the purpose of the EU ETS the benchmarks are related to the GHG efficiency of production processes, expressed as greenhouse gas (GHG) emission intensity, more specifically as “direct emissions [t CO_{2(e)}] per tonne of product”, with the benchmark set as the average GHG efficiency of the 10% best installations in the sector in the EU (Article 10a(2) of the EU ETS Directive). Such an approach requires a sound method to ensure equal treatment of installations across a wide range of circumstances found at installations. This is outlined in Annex A (chapter 7).

Where only one product is produced at an installation, it is relatively simple to determine such GHG efficiency. There is just the need to monitor the emissions as well as the quantity of (saleable) product¹⁰. However, the typical installation in the EU ETS produces more than one product. In such a case it is necessary to split the emissions by making meaningful measurements or assumptions, before the GHG efficiency (emissions/production) can be calculated. In the EU ETS the enabling concept for providing such emission splits is called “**sub-installations**”. The shortest possible description of a sub-installation would be:

A **sub-installation** is described by system boundaries of a mass and energy balance, encompassing inputs, outputs and emissions for the purpose of ensuring that benchmarks can be determined for a product or group of products, independent of which other products (including heat or electricity) are produced in the same installation, if any.

The above definition hints at an abstraction from other concepts to divide installations, in particular from physical units such as boilers, kilns, distillation columns, CHP¹¹ units etc. The difference can be one in space (one sub-installation can encompass several units¹², but also one physical unit can serve several sub-installations¹³), but also with regard to the time dimension (one and the same physical unit can be used consecutively for different sub-installations¹⁴). A detailed example of the split of an installation into sub-installations is presented in section 4.5. Further examples (including further steps to calculate the allocation) can be found in guidance document No. 2.

⁹ For EU ETS purposes it must be kept in mind that a benchmark is *not* an emission limit value that must be achieved by an installation. The benchmark is just one of several input values required for sharing the total available number of allowances among EU ETS participants.

¹⁰ Annex I of the FAR contains product definitions. They do not always refer to saleable quantities. More details are discussed in section 6.8.

¹¹ Combined Heat and Power production, also referred to as cogeneration.

¹² E.g. the mineral oil refinery benchmark may encompass a dozen or more units situated on a site of some km².

¹³ E.g. where a boiler produces steam that is used for heating several production processes belonging to different other sub-installations.

¹⁴ E.g. where in one reactor different chemicals are produced throughout the year, or where a paper machine can be switched between various paper grades.

The same concept is also applicable to the so-called “fall-back approaches”, i.e. rules for allocation to parts of installations that are not covered by product benchmarks. These are:

- The heat benchmark (for *measurable* heat) sub-installations;
- The fuel benchmark sub-installations;
- Process emissions sub-installations.

For a more detailed explanation of the concept (in particular in the context of determining “attributable emissions”, which is an essential need of the monitoring and reporting for allocation purposes, please consult Annex A (chapter 7).

Note: EU ETS Directive Annex I clause 5 requires that “*When the capacity threshold of any activity in this Annex is found to be exceeded in an installation, all units in which fuels are combusted [...] shall be included in the greenhouse gas emission permit*”. This often leads to situations where an installation has only one product benchmark (e.g. lime) and a smaller heat or fuel benchmark sub-installation (e.g. for the purpose of heating auxiliary equipment (such as the dryer in the example in section 4.5) or heating of offices and workshops at the installation.

4.2 What are “inputs, outputs and emissions” of a sub-installation?

When looking into the definitions of sub-installations in the FAR¹⁵, the common element is that “inputs, outputs and emissions” together form the sub-installation, i.e. they define the boundaries of each sub-installation, where “boundary” is understood to relate to a mass and energy balance which ultimately allows

- a. The calculation of the GHG efficiency of each sub-installation, with the aim of creating a “benchmark curve”, in order to calculate the benchmark value for a product; and
- b. To calculate the allocation of allowances for each sub-installation by applying the benchmark determined under point a.

In order to achieve consistency between both intended uses of the sub-installations, system boundaries must be identical for both purposes. Consequently, the same data reported by operators can be used for both purposes, which allows for reasonable efficiency in the Monitoring, Reporting and Verification (MRV) of the relevant NIMs “baseline data”¹⁶. This is why the FAR cover both purposes, requesting the “Monitoring Methodology Plan” (MMP, see chapter 5) as well as the “baseline data report”¹⁷ to cover both data sets in order to ensure that all relevant data is monitored and reported.

¹⁵ Article 2(2), (3), (5) and (6)

¹⁶ “NIMs” means the “National Implementation Measures” pursuant to Article 11 of the EU ETS Directive, i.e. the data a Member State has to collect from the operators of installations in order to submit them to the Commission, for calculating the updated benchmark values and the free allocation.

¹⁷ The main information source on the “baseline data report” is guidance document No.3, as well as the Commission’s template for this report.

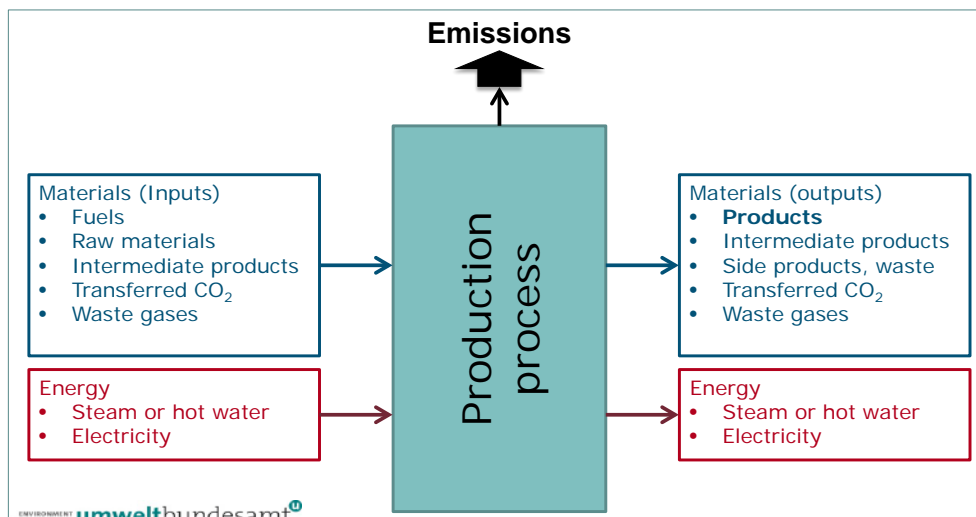

Figure 1: Generic approach to defining a sub-installation by considering the mass and energy balance of a production process which should be subject to benchmarking.

For better understanding of “inputs, outputs and emissions”, we consider a fictitious, very general production process which may be covered by the EU ETS (see Figure 1). This process has the broadest possible list of inputs and outputs, as follows:

- Input materials under the mass balance aspect:
 - Fuel, i.e. materials which are combusted for generating heat for the use in the process under consideration or elsewhere. Both the fuel quantity (and in particular its carbon content / emission factor) as well its energy content are relevant for attributing it to the sub-installation. The energy content is not directly used for allocation or benchmark calculation, but for corroboration of the correct attribution across the whole installation.
 - Raw materials, i.e. materials which participate in other chemical reactions or which are physically modified in the process for generating the product, a by-product or a waste; Note that only materials which participate in the generating of emissions are considered for monitoring, i.e. those materials which are considered “source streams” under the MRR. Where process materials fulfil these criteria and have a relevant energy content, this must be taken into account (i.e. it must be reported), even when the primary purpose of the material’s use is not energy generation.
 - Intermediate products: This means materials which fall under the product definition of a product benchmark given in Annex I of the FAR, but where for example, the process under consideration adds a finishing step. In principle the same applies as for “raw materials”. However, according to Article 16(7) of the FAR¹⁸ a specific responsibility is added for

¹⁸ Art. 16(7) of the FAR: “...In particular, where an intermediate product that is covered by a product benchmark according to the definition of the respective system boundaries set out in Annex I is imported by an installation, emissions shall not be double-counted when determining the preliminary total annual amount of emission allowances allocated free of charge for both installations concerned.”

operators to ensure that the same quantity of the product or intermediate product is not double-counted for allocation purposes.

- Transferred CO₂, i.e. (pure) CO₂ that is used within the production process: This is to be monitored like any other source stream under the MRR.
- Waste gases¹⁹ (e.g. blast furnace gas, converter gas etc.): From the MRR perspective these, too, are normal source streams which need to be monitored like other fuels. However, separate monitoring is required for FAR purposes²⁰: Where the waste gas is not fully consumed in the same sub-installation where it is produced, a part of the waste gas is attributed to the sub-installation producing the waste gas, and the remaining part to the sub-installation consuming it. Note that those two sub-installations may be part of separate installations. Thus, only the “consumer part” of the waste gas stream must be taken into account when a waste gas (in accordance with the definition of the FAR) is input to a sub-installation.
- Energy inputs:
 - The energy contained in fuels and raw materials, as mentioned in the bullet points above.
 - Energy contained in a heat transfer medium such as hot water, steam, etc.: Such energy is referred to as “measurable heat” by the FAR. “Net measurable heat” is the quantity to be monitored, i.e. the difference between the enthalpy of the heat medium entering the process and the one returning (in case of steam, the return is usually called “condensate”). Furthermore, information on the origin of the heat is required, i.e. whether it was produced within the boundaries of the EU ETS or outside. Sections 6.9 to 6.12 of this document, as well as guidance document 6 provide further information on monitoring the required parameters.
 - Electricity input: In the context of the EU ETS, where the benchmark relates to *direct emissions*, it is not straightforward why electricity input would be required for the full energy balance of a production process. In most cases this element is not relevant for the operator. However, for several product benchmarks the FAR lay down that “exchangeability between electricity and fuels” is relevant. Those product benchmarks’ system boundaries define which uses of electricity are to be considered and so need to be monitored and reported for use in the allocation formula. More information is found in GD 2.

¹⁹ According to Article 2(11): “waste gas’ means a gas containing incompletely oxidised carbon in a gaseous state under standard conditions which is a result of any of the processes listed in point (10) [i.e. in the definition of the process emissions sub-installation], where ‘standard conditions’ means temperature of 273,15 K and pressure conditions of 101 325 Pa defining normal cubic metres (Nm³) according to Article 3(50) of Commission Regulation (EU) No 601/2012”.

²⁰ As such gases often exhibit a low usable energy content (NCV) but a high emission factor, the FAR apply special rules to the attribution of waste gas-related emissions to sub-installations in order to level the playing field to the extent possible between users of waste gases and users of other fuels. For more information refer to Guidance Document No. 8 on waste gases.

- Output materials under the mass balance aspect:
 - **Products:** These are the (physical) products of the sub-installation monitored, such as “tonnes of facing bricks”. For product benchmarks the operator has to ensure not only correct quantification (in most cases the saleable production), but also whether the product complies with the specific product definition (in this case: “Facing bricks with a density > 1000 kg/m³ used for masonry based on EN 771-1, excluding pavers, clinker bricks and blue braised facing bricks.”). In many cases this will mean comparing the product’s quality with a definition given for one or more specific PRODCOM codes. Several special rules apply, e.g. CWT approach for refineries, special metering points instead of saleable products (e.g. for glass bottles and jars), or normalising the quantity sold to a reference state based on chemical analyses (e.g. for lime and dolime).
 Note that where a mass balance is applied for MRR purposes (i.e. where significant amounts of carbon remain in the product) the carbon content and, where relevant, its energy content have to be recorded for determining the emissions and the energy balance. However, the main purpose of monitoring the quantity of products is that it is the main input to the allocation calculation, as well as for determining the updated benchmark values.
 In the case of “fall-back” sub-installations the main reason for monitoring products is to ensure their correct treatment regarding significant risk of carbon leakage, where applicable.
 Annex IV, section 2.6 point (b) requires that the operator reports quantities of products (aggregated by PRODCOM code) for all types of sub-installations (i.e. also for fall-back sub-installations).
 - Intermediate products: See above under “inputs”. A decision is necessary on whether the intermediate product is to be considered a “product” under this sub-installation, or of the sub-installation in which the finishing to “product” is carried out, in order to avoid double-counting of the allocation. Otherwise only potential carbon or energy content need to be monitored.
 - Side products (by-products) and waste: like other materials, these only need to be monitored if relevant in terms of carbon content for the determination of the sub-installation’s emissions, and energy content for corroboration purposes.
 - CO₂ transferred out of the (sub-)installation: relevant for determination of the sub-installation’s emissions (rules set out in Article 49 and Annex IV of the MRR should be taken into account).
 - Waste gases: See above under “inputs”. If a waste gas is exported from the sub-installation, a part of its emissions is accounted for under the sub-installation which is producing the waste gas, and only an CO₂ equivalent to natural gas of the same energy content (multiplied by a correction factor for differences in reference efficiencies) is counted as exported.

- Energy outputs:
 - Measurable heat exported from a product benchmark sub-installation is to be treated like a second product, i.e. a certain amount of emissions must be subtracted²¹ from the emissions of that sub-installation (which means the sub-installation is more efficient than another installation with similar emissions, but no heat export).
 However, the situation is different for heat benchmark sub-installations and the district heating sub-installation. As their “product” is the measurable heat, it counts towards their own activity level even if exported to other installations, except where the installation receiving the heat is eligible for allocation itself. In other words, only export of heat to non-EU ETS installations or entities is eligible for allocation under the heat benchmark. However, the amount of eligible heat for these sub-installations is the outcome of a more complex installation-wide calculation, which is discussed in section 6.12.
 - Electricity produced: In principle electricity production is not eligible for any free allocation, and therefore it is formally never part of a sub-installation. Nevertheless electricity can be produced in processes which are otherwise (e.g. due to their physical integration in units used for the purpose of the sub-installation) considered inside the (product) benchmark sub-installation, e.g. expansion turbines, CHP plants in some cases²², etc. As explained for measurable heat, electricity is also a “second product”, for which a deduction from the attributed emissions is needed to reflect the additional efficiency of the process.
- Emissions:
 - **Direct emissions in line with the MRR:** In line with the installation’s approved monitoring plan²³ the installation’s emissions are determined using either a calculation-based methodology (i.e. based on source streams), a measurement-based methodology (using Continuous Emission Measurement Systems, CEMS), a non-tier approach (“fall-back methodology”), or combinations thereof. All GHGs (CO₂, N₂O, PFCs) will be monitored (the latter two only occur in the process emission sub-installation, or in a few product benchmark sub-installations). Often it will be simple to split these emissions into sub-installations, where source streams are used only by a single sub-installation, or where an emission source monitored by CEMS is fully attributable to a single sub-installation. However, it is likely that more complicated splits must be made. This will usually take into account the following considerations (combinations of these approaches may be necessary, depending on an installation’s situation):
 - Source streams are split using the same approach as applied above for the respective fuels and materials, ensuring that the correct NCVs and emission factors are used.
 - In the case of CEMS, proxy values used for “corroborative calculations” (mandatory for all CO₂ CEMS under the MRR) can be used to assign the source streams instead of the

²¹ Note that the emissions to be deducted here are only to be reported by the operator if the respective fuel mix (emission factor and boiler efficiency, if applicable) are known. In other cases only the quantity of heat are to be reported.

²² E.g. recovery boilers integrated with CHP systems in chemical pulp sub-installations.

²³ “Monitoring Plan” (MP) in this document always means the one approved under the MRR. “Monitoring Methodology Plan” (MMP) always means the plan relevant under the FAR.

measured emissions in order to determine a proportionality factor by which the measured emissions can be split to sub-installations.

- At sub-installation level, a few source streams may have to be monitored which are not included in the MP under the MRR. For example, where an integrated steel plant (including a coke oven and a power plant for waste gas use) is monitored under one mass balance (“bubble” approach), neither the coke nor the waste gases produced need to be monitored, but only the coal entering the coke oven. If this happens, the sub-installation level monitoring requires the amounts of coke and waste gases, as well as their NCV and carbon content, to be monitored. In this document and in the Commission’s templates these source streams are referred to as “internal source streams”. However, it must also be noted that for the purpose of limiting administrative burden, the FAR do not require the operator to apply specific tiers for such monitoring. Taking into account the hierarchy of approaches given in the FAR (see section 6.6) approaches avoiding unreasonable costs can be chosen.
- Where physical units serve several sub-installations (in particular units producing measurable heat) the preferred method (which is reflected in the Commission’s reporting templates) is to first determine the specific emissions per TJ of measurable heat using the relevant fuel mix (and including process emissions from flue gas cleaning), and thereafter attribute the emissions of that physical unit to the different sub-installations using the quantities of heat consumed in the different sub-installations. Note in this context the special rules for splitting emissions from CHP units into emissions attributed to electricity and to heat (see section 6.10).
- In order to avoid double counting or data gaps, it is often advisable to determine the emissions of $(n-1)$ sub-installations by the approaches above, if the installation has n sub-installations. The emissions of the last sub-installation are then calculated as the difference between the whole installation’s emissions and the emissions of the other $(n-1)$ sub-installations²⁴. Note, however, that there are cases of emissions and other data which do not belong to any type of sub-installation (see box on page 22). In those cases, this “non-eligible” fraction can be considered a “virtual sub-installation” for testing if 100% of the data is attributed.
- “**Attributed emissions**” are a wider concept than the direct emissions. They are **required for establishing the benchmarking curves** for the update of the benchmark values. They take into account that comparability between different installation configurations needs to be established, as discussed in section 4.1. Therefore, certain “indirect emissions” have to be taken into account, when updating the benchmark values in line with the methodology used for the third EU ETS phase. As is shown in section 4.3, the following additions to the direct emissions under the MRR have to be made:
 - Addition of emissions for imports of measurable heat: If available, the operator has to report the actual emission factor of the imported heat. Where the actual emission factor cannot be determined, the attributed emissions will be determined at a later stage using the amount of measurable heat reported for the relevant sub-installation

²⁴ This approach is advisable also for all other data sets to be attributed to sub-installations. See the box on p. 23 for which data sets cannot be attributed to sub-installations.

(as the value of the [updated] heat benchmark is not known at the time of data collection);

- Deductions made for heat exports;
- Where a waste gas is imported and consumed, only the “consumption”-related fraction of the direct emissions are accounted for (i.e. a deduction is applied to the direct emissions, see section 7.3);
- If waste gases are exported from the sub-installation, the “production”-related fraction remains at the sub-installation (is added to the direct emissions);
- Addition of an emission equivalent for “exchangeable” electricity, if applicable;
- Sub-traction of an emission equivalent for electricity production, if applicable.

Important Notes:

The split of data from installation level to sub-installations as described in the bullet points above is relevant for the complete MRV system under the FAR, i.e. all the data mentioned (if applicable at the individual installation) must be reported in the “baseline data report”. Therefore the monitoring methodology plan must contain information on how each data set is determined for each sub-installation.

For completeness it must be mentioned here that after performing the attribution of all inputs, outputs and emissions to sub-installations, some inputs, outputs and emissions will remain *not attributed to any sub-installation*, as these elements are not eligible for free allocation. In particular this concerns:

- Fuels and/or measurable heat used for electricity production, and the related emissions;
- Measurable heat produced in nitric acid sub-installations, from electric boilers or imported from non-ETS entities;
- Emissions related to heat exported to EU ETS installations²⁵;
- Waste gases or fuels flared for purposes other than safety flaring outside product benchmark sub-installations, and related emissions.

For limiting administrative burden, the split into sub-installations may be simplified by applying the “95%” rule when attributing “de-minimis” parts of the installation to sub-installations (Article 10(3) of the FAR). More information is given in section 4.4.

²⁵ Note that this refers to the view of the exporting installation. It does not mean that such heat is not eligible for allocation at all. However, the allocation (and hence attribution of the heat quantity) takes place at the receiving installation.

4.3 Attributed emissions

For the purpose of updating the benchmark values (i.e. for generating new benchmark curves), more than just the direct emissions of a sub-installation needs to be taken into account. This is because the aim is to compare the “real emissions” (to the extent these are known) for the complete production process with its peers, but only for the production of this one product. The aim is that the specific GHG emissions per tonne of product from each installation have to be made comparable to each other, i.e. system boundaries must be strictly consistent, and related rules must be obeyed by operators.

The method for attributing emissions to sub-installations is given in Annex VII section 10 of the FAR. For calculating the “attributed emissions” of each sub-installation the following formula is used (note that not all terms are relevant for all types of sub-installations; for further information see the Annex (section 7.3) and the examples contained therein):

$$AttrEm = DirEm^* + Em_{H,import} - Em_{H,export} + WG_{corr,import} - WG_{corr,export} + Em_{el,exch} - Em_{el,produced}$$

The variables of this equation are explained in Annex A (section 7.3), and detailed examples in that Annex provide guidance to operators for developing their MMP with a view of ensuring completeness of data without overlaps in their baseline data reports.

4.4 Further rules on splitting data into sub-installations

The FAR contain some specific rules on practical approaches to splitting data according to sub-installations. These are:

- **Distinction between carbon leakage (CL) / non-CL:** Article 10(3) requires that the heat benchmark sub-installation, fuel benchmark sub-installation and process emission sub-installation are each split into two (in case of heat even three) separate sub-installations of these types, where relevant, depending on the sector’s risk of carbon leakage. The split is carried out on the basis of the PRODCOM or NACE²⁶ codes to which the production processes and/or final (physical) products correspond. I.e. if measurable heat is used for the production of a product deemed not at risk of carbon leakage, this amount of heat is attributed to the “non-CL heat benchmark” sub-installation, while another amount of measurable heat within the same installation may belong to the “CL heat benchmark” sub-installation.
- **The “95% rule”:** As a simplification of the above rule, a de-minimis rule was introduced. It allows an operator to not make this split, if more than 95% of the related activity level (in

²⁶ NACE codes always means “NACE Rev 2.0” as laid down in Regulation (EC) No 1893/2006 of the European Parliament and of the Council of 20 December 2006 establishing the statistical classification of economic activities NACE Revision 2 and amending Council Regulation (EEC) No 3037/90 as well as certain EC Regulations on specific statistical domains (OJ L 393, 30.12.2006, p. 1).

the example of the first bullet point: the total measurable heat not falling under a product benchmark sub-installation) belongs to either CL or non-CL sub-installation.

In the same spirit the district heating sub-installation has been included in this simplification rule: If either of the three²⁷ heat benchmark sub-installations consumes more than 95% of the total heat, the remaining less than 5% may be attributed to the same sub-installation.

- **Completeness checks** (Article 10(5) of the FAR): When designing the MMP, and throughout monitoring and reporting, the operator shall regularly carry out checks on data completeness, as laid down in Article 10(5) of the FAR. These checks include the completeness of source streams and emission sources, measurable heat flows, waste gas flows, physical products and their PRODCOM codes, etc., in line with the considerations given in sections 4.2 and 7.3.
- Specific rules for **avoiding double counting**:
 - Products of a production process returned into the same production process are deducted from annual activity levels (point (j) of Article 10(5)). Where the activity level according to Annex I of the FAR refers to the amount of saleable product, this rule is not relevant.
 - Where measurable heat is produced by recovery from another sub-installation, in particular from flue gas streams coming from a fuel benchmark sub-installation, but also all other types of waste heat), such heat can be eligible for inclusion in the heat benchmark sub-installations. For avoiding double counting, the amount of heat divided by a reference efficiency of 90% is to be deducted from the sub-installation where the heat is recovered (point (k) of Article 10(5)). Where the deduction has to be expressed in terms of t CO₂, a suitable conversion factor (heat or fuel benchmark, as applicable) is to be used.

4.5 Example for splitting an installation into sub-installations

In the – fictitious – example installation (shown in Figure 2) the following physical units are operated:

- A kiln for cement clinker production
 - Waste heat from the exhaust gas is supplied to a district heating network
- A cement grinding plant²⁸, where a directly fired dryer is used for some raw materials
- A kiln for lime production, in which during some months of the year magnesite is burnt instead of lime.

²⁷ CL, non-CL heat benchmark sub-installation, and district heating sub-installation.

²⁸ Cement grinding plants, when operated as stand-alone installations, are usually not EU ETS installations, since their combustion units (if any) are usually below 20 MW rated thermal input. However, in this example (which is purely illustrative), the assumption is that the grinding is within the boundaries of the EU ETS installation. This is based on the fact that it contains a combustion unit (the dryer), and EU ETS Directive Annex I clause 5 requires for such cases: “all units in which fuels are combusted [...] shall be included in the greenhouse gas emission permit”.

If the operator of such installation is to develop an MMP or a baseline data report, the following steps would be carried out.

Step 1: List all physical units, inputs, outputs and emissions

As a first step the operator should list all physical units, their inputs, outputs and emissions as shown in Table 1. Only thereafter he can proceed to identify which types of sub-installation are relevant (using the sequence given in Article 10(2) of the FAR), before attributing inputs, outputs and emissions to these sub-installations. This may require an iterative approach, as it may not always be obvious in the first instance which sub-installations are relevant. The example here furthermore illustrates the relationship between physical units and sub-installations, as this is often useful for further development of the monitoring approaches.

Note: The FAR define sub-installations only via “inputs, outputs and emissions” (see section 4.2 of this document). Hence there is no formal requirement to attribute physical units to sub-installations, in particular because – as also shown in this example – there are often physical units which serve several sub-installations. Therefore, the exercise of “attributing” physical units should be understood just as a useful step in the practical approach of designing an MMP.

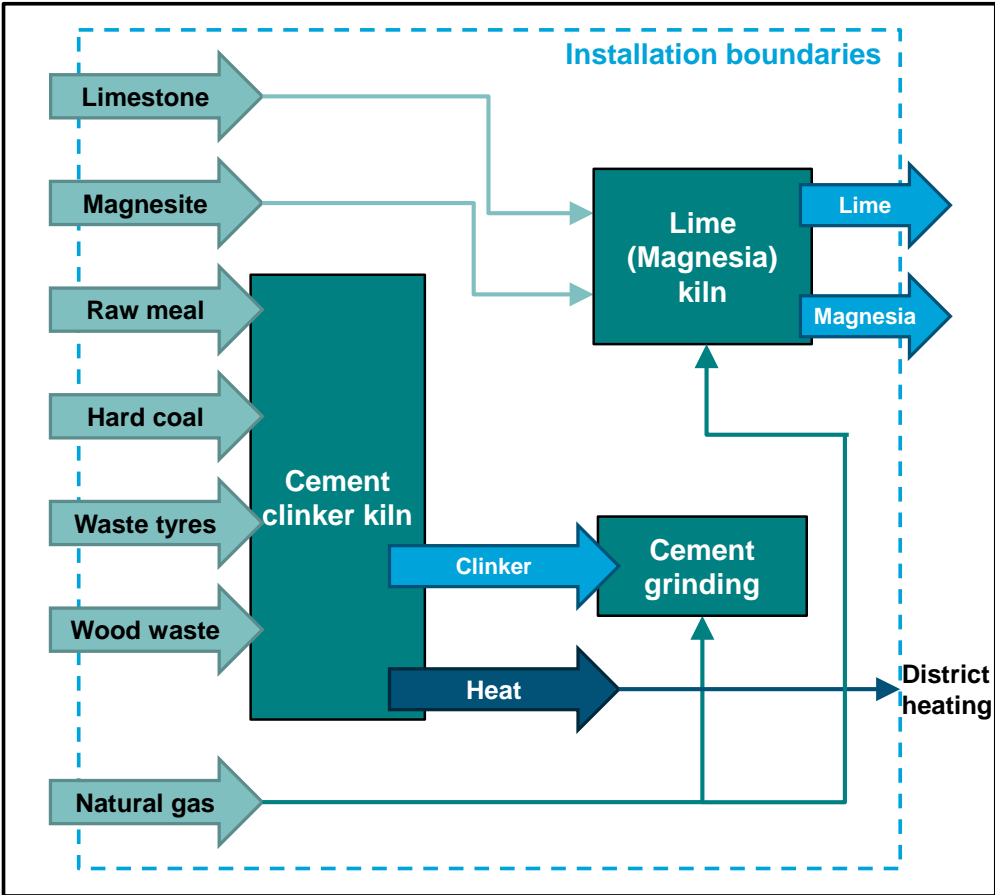

Figure 2: Fictitious example installation for illustrating the sub-installation concept.

Table 1: List of physical units, inputs, outputs and emissions of the example installation required for splitting the installation into sub-installations in line with the FAR. This table illustrates the situation before carrying out the steps described in the main text.

Inputs	Physical units	Outputs	Emissions
<ul style="list-style-type: none"> ● Hard coal (to cement clinker kiln) ● Waste tyres (to cement clinker kiln) ● Wood wastes (to cement clinker kiln) ● Natural gas (to dryer and lime kiln) ● Raw meal ● Lime stone ● Magnesite 	<ul style="list-style-type: none"> ● Cement clinker kiln ● Grinding plant (including dryer) ● Lime/magnesium oxide kiln ● (Heat exchanger for district heating) 	<ul style="list-style-type: none"> ● Clinker ● Cement(s) ● Lime ● Magnesium oxide ● District heating 	<ul style="list-style-type: none"> ● From coal ● From tyres ● Biomass (zero-rated) ● From natural gas ● Process emissions from raw meal ● Lime process emissions ● MgO process emissions

Step 2: Identify relevant sub-installations

- Identification of **product benchmark sub-installations** using the product definitions of Annex I to the FAR:
 - The operator identifies that the cement clinker produced falls within the definition of the “grey cement clinker” benchmark;
 - The operator identifies the lime produced to fall within the definition of the “lime” product benchmark;
 - The operator assesses the composition of the magnesium oxide which results from the burning of magnesite. As it does not contain significant amounts of calcium oxide, it does *not* fall within the definition of the dolime or sintered dolime benchmark. Consequently, fall-back sub-installations will be relevant for this process.
- Identification of potential **heat benchmark sub-installations**:
 - The only case of measurable heat found in this example is the heat generated from the waste heat of the clinker benchmark sub-installation. For deciding which sub-installation is relevant, the operator must assess if he has evidence for the use of the measurable heat. In the example it is assumed that the operator is co-owner of the heat network. The other owner is a local electricity and heat providing company. The latter acts as a service company that is responsible for the contracts and invoicing of the heat end-users. With support of the service company the operator of the example installation is able to categorize the heat users as private households, with the exception of one consumer which is a small factory that produces essential oils and perfumes. The NACE codes for these products are 2053 and 2042, which are both not found on the Carbon Leakage List (CLL). However, as the operator has evidence for all baseline years that the heat delivered to this factory was usually around 4% of the total heat produced, he can make use of

Article 10(3) of the FAR and consider the whole measurable heat to fall within the district heating sub-installation²⁹.

● **Fuel benchmark sub-installations:**

- Fuel use in this example installation – outside the earlier mentioned sub-installations – is found at two occasions: the dryer of the cement grinding plant, and in the magnesite burning.
- The operator now has to assess if these two processes are considered to belong to sectors exposed to carbon leakage. The operator here concludes that both processes belong to sectors found on the CLL³⁰. Consequently, only the “CL fuel benchmark sub-installation” is relevant in the example.

● **Process emissions sub-installations:**

- The only process emissions not covered elsewhere are related to the decomposition of $MgCO_3$ to MgO in the magnesite burning. As stated under the fuel benchmarks, this process can be considered to belong to a sector exposed to carbon leakage. Therefore the “CL process emissions sub-installation” is relevant.

Step 3: Assign inputs, outputs, emissions (and physical units) to sub-installations

The operator of the example installation uses Table 1 as a checklist for assigning the relevant materials and fuels to sub-installations. This is relatively simple in most cases:

● **Grey clinker sub-installation:**

- Physical units: Cement kiln, including preheaters, pre-calciner, clinker cooler, auxiliary equipment, etc. Since this is a relatively self-standing part of the installation (at least in this example), there is no doubt about physical boundaries to other sub-installations. The heat exchanger for the district heating, including boiler water preparation, relevant metering equipment etc. can be clearly identified both in real life and on the plans and flow charts attached to the MMP.
- Inputs:
 - Fuels: Hard coal, waste tyres, wood wastes. In the example there is no flue gas cleaning which gives rise to further emissions (no De-NOx).
 - Process materials: Raw meal as already monitored for MRR purposes (Method A – input based).
- Outputs (products): Only cement clinker is the relevant product for the activity level. If not already monitored for MRR purposes, additional monitoring has to be introduced for this main parameter for allocation purposes. The measurable heat is considered an export of this sub-installation to another sub-installation.

²⁹ Without this evidence, both district heating and non-carbon leakage heat benchmark sub-installation would be relevant.

³⁰ Production of cement: NACE 23.51. Magnesium oxide is not explicitly found on the PRODCOM list. However, depending on its further use it might be considered a refractory material (NACE 23.20) or inorganic basic chemicals (NACE 20.13) – both NACE codes are found on the CLL.

- Emissions: Monitoring is fully covered by the MP under the MRR, as none of the relevant fuels or materials is used in other sub-installations. Note that the waste tyres and wood wastes partly lead to biomass emissions which are zero-rated. Under the FAR the same monitoring rules apply for such biomass emissions as under the MRR.
- Attributed emissions: When determining the “attributed emissions” of this sub-installation, a relevant amount of emissions needs to be deducted for the heat export to the district heating sub-installation. See “district heating sub-installation” below.
- Lime sub-installation:
 - Physical units: Lime kiln and auxiliary equipment. Note that the lime kiln is shared with the magnesium oxide production (fuel benchmark and process emissions sub-installations). For identification of when the lime kiln falls within the lime sub-installation, the operator has to monitor when it is used for which production process. I.e. there has to be an effective system for distinguishing and documenting these production processes (including unambiguous assignment of times of transition between processes to either of the processes).
 - Outputs (products): The operator uses Method B (output based) under the MRR. Therefore the lime output required for the activity level of the sub-installation is already known. In this case, this includes the composition data (content of free CaO and free MgO in the product, which are required to calculate the HAL corrections in line with Annex III to the FAR).
 - Inputs:
 - Lime stone: No monitoring required, as it is not required for allocation purposes, and quantification is possible indirectly using the stoichiometric relationship to the product.
 - Natural gas: Since natural gas is also used for other purposes, monitoring in accordance with the MP under the MRR is not sufficient. More details are given below under step 4.
 - Emissions: The lime process emissions can be deducted from MRR data. The emissions from natural gas can be determined using the same emission factor as for the total natural gas in line with the MP under the MRR. However, the amount of natural gas for this calculation has to be determined as explained under step 4 below.
 - Attributed emissions: Identical to “emissions” above.
- District heating sub-installation:
 - Physical units: Heat exchanger and all the auxiliary equipment for running the heat distribution network (including water treatment, metering, pumps, etc.) are clearly identifiable.
 - Inputs: None relevant (fuels are considered part of the grey cement clinker sub-installation).
 - Outputs (products): Measurable heat exported from the installation.
 - Emissions: None.
 - Attributed emissions: In accordance with the FAR there is no need to report attributed emissions for measurable heat imported or exported from sub-installations, if the emission factor of the fuel mix is unknown. Only the heat quantities themselves need to be reported.

- CL fuel benchmark sub-installation:
 - Physical units: Lime kiln (at times when no lime is produced, but magnesite is burnt); Dryer of the cement grinding plant.
 - Inputs: Natural gas. For monitoring requirements see step 4 below.
 - Outputs (products): Several grades of cement; Magnesium oxide.
 - Emissions: Emissions proportionate to the natural gas quantities attributable to this sub-installation, using the emission factor in accordance with the MP under the MRR.
 - Attributed emissions: identical to “emissions”.
- CL process emissions sub-installation:
 - Physical units: Lime kiln at times it is not operated under the “lime” product benchmark sub-installation.
 - Outputs (products): Magnesium oxide. As for lime, it is assumed that method B (output-based) is used for monitoring under the MRR, and the data is therefore already available.
 - Inputs: Raw magnesite. Not relevant for monitoring in this example.
 - Emissions: As available under the MRR, proportionate to the quantity of magnesium oxide produced.
 - Attributed emissions: Identical to “emissions”.
- Completeness check:
 - The operator finds no input, output or emissions within the installation’s boundaries which have not been assigned to a sub-installation. If there were some unattributed items, the operator would check if they are on the list given in the box on page 22.
 - Furthermore, there is no identified need to monitor electricity quantities, since no electricity is produced, and none of the product benchmarks is identified in Annex I of the FAR to have exchangeability of fuels and electricity.
 - Waste gases are not relevant, and neither is transfer of CO₂ from or to other sub-installations or installations. There is also no flaring. Therefore, related sections in the templates for the MMP and the baseline data report can be omitted.

The final result of the sub-installations’ definition is shown in Figure 3.

Step 4: Identify monitoring needs

In this example installation only a few data sets need to be monitored in addition to what is already monitored under the MRR:

- **Activity level** of each sub-installation: This is the most important parameter for allocation purposes. It is also to be reported on an annual basis for the purpose of potential allocation changes³¹. In the example installation, this requires the following:
 - Grey cement clinker: As above it was assumed that the emissions from clinker production are monitored on an input basis according to the MP, the monitoring of grey cement clinker is a new monitoring requirement.

³¹ Details will be found in the ALC Regulation. If necessary, this document will be updated accordingly.

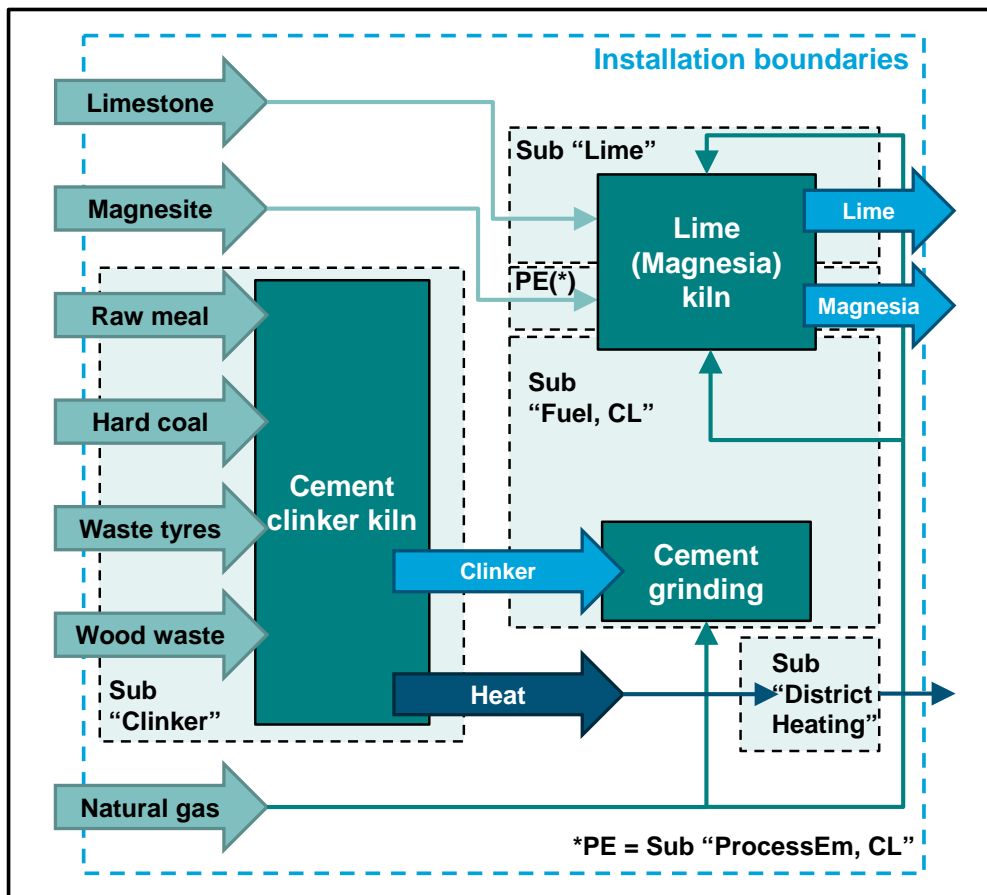

Figure 3: Final result of the sub-installation definition example.

- Lime: The quantity is already monitored for the output-based emissions monitoring. However, for FAR purposes all output data must be corrected with composition data (Annex III of the FAR) in order to establish the actual activity level. However, it can be assumed that the required data is already available for MRR purposes (i.e. for determining the emission factor and conversion factor).
- District heating sub-installation: The amount of heat exported needs to be determined on annual basis.
- CL fuel benchmark sub-installation: The total energy input to this sub-installation (expressed as Terajoules, i.e. fuel quantity multiplied by its NCV) needs to be monitored. See "split of natural gas" below.
- CL process emissions sub-installation: As said above, the emissions can be directly taken from MRR data, as the magnesite is fully attributable to this sub-installation.
- **Split of natural gas:** Natural gas in this example is used in two physical units (lime kiln and dryer) belonging to two different sub-installations (fuel benchmark sub-installation and lime benchmark). For assigning the correct amount of natural gas to each sub-installation, at least two measures are required by the operator:

- At least one sub-meter is required for distinguishing the gas quantity going into the dryer of the cement grinding plant and the gas used in the lime kiln. Due to the other requirement below, it is preferable to have that gas meter installed at the lime kiln. If no appropriate meter has been installed already before, the historical data will have to be determined based on an indirect method (correlation or estimation).
- Readings of the gas meter at the lime kiln are required every time the switch between lime production and magnesium oxide burning is performed. Should such meter not be available, another method would be required, as elaborated in section 6.5.
- **Production figures:** For the fall-back sub-installations there is a need to monitor the associated products, although they do not establish an activity level relevant for allocation. However, the competent authority requires the qualitative (the relevant PRODCOM codes) as well as the quantitative information (production levels) for plausibility checking. Also, the verifier will consider the information relevant for performing checks. In this example installation, the operator will have to monitor:
 - Quantities of cement: At least the two PRODCOM categories “Portland cement” and “other hydraulic cements”, but other categories may apply as well.
 - Magnesium oxide: The quantity will be derived from MRR data
 - District heating: As it was mentioned in the installation description that there are not only private households as consumers, the operator will have to check if the industrial consumer remains under the 5% threshold for remaining included in the district heating sub-installation, and whether other industrial consumers (including potentially CL exposed ones) are added to the network.

4.6 Terms used in the MRR and AVR (emissions monitoring)

For monitoring of data under the FAR, concepts are used that are familiar to operators, verifiers and competent authorities from the MRR and the AVR. To avoid duplication of guidance material, it is assumed here that the reader is either familiar with these concepts or will refer to the relevant MRR and AVR guidance material (for an overview see section 1.2 of this document).

As there are a few specific differences between the concepts of MRR, AVR and FAR, some of the most important similarities and differences are discussed here. For further information on the monitoring approaches for emissions, the reader is referred to MRR GD 1 (general guidance for installations), unless other documents are mentioned:

- **Underlying principles** (Section 4.1 of MRR GD 1): Completeness, consistency and comparability, transparency, accuracy, integrity of methodology, continuous improvement. Although not explicitly mentioned in the FAR, it must be considered at least good practice to apply these principles. Not respecting those principles will make reports under the FAR time consuming and difficult to verify.
- **Calculation-based approaches** (standard method and mass balance method): Relevant terms include

- **“Source streams”** meaning carbon-containing fuels or materials which have to be monitored; Note that the FAR requirement to monitor emissions at sub-installation level leads to the term **“internal source stream”** used in the baseline data template and MMP template by the Commission. This relates to source streams which are produced by one sub-installation and consumed by another one within the same installation, so that at installation level they give net zero emissions.
- **“Activity data”** meaning the amount of material or fuel, not to be confused with the term “activity level” used for sub-installations in the FAR;
- **“Calculation factors”** including net calorific value (NCV), emission factor, oxidation factor, conversion factor, carbon content, biomass/fossil fraction;
- **Measurement-based approaches** using CEMS (Continuous Emission Measurement Systems) applied to **“emission sources”**;
- **No-tier approaches** used where an operator cannot reach even tier 1 for at least one source stream or emission source. These are referred to as **“fall-back methodology”**. However, for the MRR this term relates only to installation-level emissions and must not be confused with the term “fall-back approach” or “fall-back sub-installation” used in the context of free allocation rules. The latter term means one of the heat benchmark, fuel benchmark or process emissions sub-installations (see also section 7.2 of this document).
- **“Combustion emissions”** and **“process emissions”**: From the MRR perspective these two terms are mainly distinguished for the purpose of defining which calculation factors are relevant. For combustion emissions the monitoring of an NCV value and oxidation factor is mandatory, while for process emissions a conversion factor applies (the distinction is less clear within a mass balance approach). For the FAR, important differences have to be noted:
 - Process emissions attributable to one of the process-emissions sub-installations are clearly defined by Article 3(j) of the FAR. The definition applies only to process emissions not attributed to any other sub-installation type, and contains a correction for waste gases, whereby less than the total direct emissions are attributed (for details see sections 4.3 and 7.3).
 - Process emissions from flue gas cleaning (desulphurisation, deNO_x) are considered part of the fuel mix for determining the emission factor of measurable as well as non-measurable heat.
- **Biomass** emissions: These are accounted for as zero under the MRR, provided that sustainability criteria defined by the RES Directive³² are complied with, where applicable. MRR guidance document No. 3 gives further details on biomass. The FAR follow that approach in full.
- **Minimum requirements** for monitoring (based on a building block system using **“tiers”**): while this is a central tool of the MRR to balance accuracy needs for biggest emitters against the administrative burden in case of smaller emitters, the concept is of little relevance under the FAR which uses an “accuracy hierarchy” concept.

³² Renewable Energy Sources Directive.

- **“Unreasonable costs”** and **“technical feasibility”** are used as criterion for deviating from minimum tier requirements. The concepts are also applicable under the FAR in relation to the “accuracy hierarchy”, although for “unreasonable costs” some of the assumptions differ. See section 6.6.2 for further details.
- **“Uncertainty”** as a systematic means of judging whether one monitoring method is “better” than another one is relevant under the FAR (see section 6.6.3). However, the need to perform a (simplified) uncertainty assessment will be an exception rather than the rule under the FAR, while for the purposes of the MRR an uncertainty assessment is usually mandatory. MRR guidance document No. 4 is dedicated to the topic of uncertainty assessment and will also be helpful for FAR purposes.
- **“Procedures”** are used in MRR context as a means to not overload the MP with too much detail, and in particular to keep the number of MP updates at a reasonable level. The MRR requires that for several monitoring tasks (such as ensuring completeness of the list of source streams, for sampling and analysis, for purposes of the control system, etc.) the operator “establishes, documents, implements and maintains procedures for activities under the monitoring plan, as appropriate”. These procedures are not considered formally part of the monitoring plan. The same approach is used in the FAR (Article 8(3)) for the MMP, although the number of explicitly mentioned procedures is small. Section 5.4 of MRR GD 1 is a good starting point to learn more about such procedures.
- **“Default values”**, i.e. diverse types of fixed values or literature values that are used for calculation factors in order to avoid the need to perform sampling and analyses. The concept is extended to further types of material properties in the FAR, in particular for establishing the quality of products where required.
- **Sampling and analyses**, as required to determine calculation factors in the MRR, or material properties in general under the FAR: The requirements set out in the MRR include the need to have a sampling plan and to use a laboratory accredited for the specific analysis method. If this is not possible, the laboratory has to demonstrate equivalent competence. Details are elaborated in MRR guidance document No. 5.
- **“Data flow procedures”** and **“control system”**, including the **“risk assessment”**: Details in the context of the MRR are given in MRR guidance document No. 6. Some information in the FAR context is given in section 5.5 of this document.
- **Verification**: For annual emissions, a broad suite of guidance is available. To start reading, EGD I (“Explanatory Guidance Document I”) is recommended. For FAR-related verification, all important aspects are covered by GD 4 of the FAR guidance series, including detailed guidance on topics such as the process of verification, competence requirements for verifiers, accreditation rules, etc.

4.7 Terms introduced by the FAR important for monitoring

Many important concepts of the FAR are explained in other guidance documents of this series. In particular for the following topics the reader is invited to consult the mentioned documents:

- A brief overview of the free allocation methodology in general is given in Guidance document No. 1. An Annex summarizes and explains many important definitions used by the FAR.
- Guidance document No. 2 explains in detail how the sub-installation data is used to determine the final allocation of the installation (applying the updated benchmarks, the CL exposure factor, cross-sectoral correction factor or linear reduction factor, etc.). Splitting the installation into sub-installations is discussed in detail.

However, these documents do not concentrate on the practical issues of monitoring the required data. In order to fill the gaps, some terms required for monitoring and reporting are briefly explained here:

- **Determination methodology**³³: This is the overarching term which covers both, forward-looking *monitoring* as well as backward-looking *data collection*. The MMP has to define determination methodologies for all relevant data sets. This implies that both aspects have to be covered (although they could in principle be contained in separate versions of the MMP, depending on the MS' requirements). Therefore, it may sometimes be necessary to mention two different approaches for the same data set within the MMP: One for the first baseline data report, which requires collection of already existing data, and a second one for future monitoring. This is based on the assumption that an operator may sometimes have only data of lower quality available for historic data, but will usually be able to use "most accurate available data sources" in line with section 4 of Annex VII of the FAR for future monitoring, since he will be able to install required meters etc.

Note that for simplicity this guidance document usually just refers to "**historical data**" where it means data already available (i.e. stemming from the period "pre-MMP-approval"). Where it needs to be clarified that only data is meant which is monitored in the future (after MMP approval), this document uses the term "**monitoring data**". Where such specification is not given, both data types are implied.

- **Data set**: This term means "one type of data, either at installation level or sub-installation level". In comparison to MRR terminology, a data set can be activity data (amount of fuel or material), or a single calculation factor (e.g. the NCV or emission factor). Due to the wider nature of data relevant for determining benchmarks or for allocation, a data set can also be an amount of electricity, measurable heat, waste gas, or a parameter relevant to determine such amounts, e.g. the flow of steam, the temperature and pressure of the steam, etc. Furthermore, data sets are not restricted to the installation level. There can also be transfers of heat or materials between sub-installations which require monitoring and which consequently have to be considered "data sets". A data set can also mean qualitative

³³ Section 2 of Annex VII of the FAR defines: 'Determination methodology' means either of the following:
(a) a methodology of identifying, collecting and processing data already available at the installation for data sets of historical data or;
(b) a monitoring methodology for a specific data set based on an approved monitoring methodology plan.

information to be monitored, such as whether or not a product or a heat consumer falls within a CL sector, whether an amount of pulp is put on the market, or whether or not measurable heat stems from an EU ETS source. Finally, individual parameters also required to determine the activity level of some special product benchmarks are considered “data sets”, such as the activity level of each individual CWT function (Annex II of the FAR), and correction factors required to calculate activity levels in accordance with Annex III of the FAR.

- **Direct and indirect determination methodologies:** For an explanation see section 6.4.
- **Data sources:** This is another overarching term, encompassing monitoring methodologies such as the chosen measuring instrument(s) and (laboratory) analyses, but also default values and estimation methods, as well as sources for historical data, such as databases or written documentation of monitoring methods and data obtained in the past.
- **Most accurate available data sources:** Article 7 of the FAR requires the operator to “*use data sources representing highest achievable accuracy pursuant to section 4 of Annex VII*”. Use of other data sources is allowed in cases where the use of most accurate data sources is technically not feasible, would incur unreasonable costs, or where the operator can provide evidence that another chosen method exhibits lower uncertainty. Annex VII section 4 of the FAR gives a hierarchy of preferred data sources according to accuracy. More details are discussed in section 6.5 of this document.
- **Primary data sources, Corroborating data sources:** The FAR require the operator to select the data source of highest accuracy for each data set. This is referred to as the “primary data source”. It is the source to be used for the baseline data report. However, as a means of quality control, the FAR also require the operator – to the extent feasible without incurring unreasonable costs – to also select, if available, a second data source for each data set, which can be lower down the hierarchy of preferred data sources according to section 4 of Annex VII of the FAR. These second sources are called “corroborating data sources”. They serve two purposes: Firstly, for the corroboration of the primary data source, i.e. for carrying out cross checks, and secondly for filling data gaps where data are missing from the primary data sources. If, for example, the measuring instrument used as primary source fails, the correlation method chosen as corroborating source is to be used. This avoids arbitrary use of non-approved methods for filling data gaps, and at the same time “forces” operators to ensure an effective control system (see section 5.5).
- **Historical Activity Level (HAL):** The HAL is the parameter which is to be multiplied with the relevant benchmark for determining the preliminary annual number of emission allowances allocated free of charge for each sub-installation. According to Article 15 of the FAR this is usually the arithmetic mean of all annual activity levels in the baseline period taking into account all years during which the installation has been operating for at least one day. In cases where the sub-installation has been operating for less than two calendar years during the relevant baseline period, the HAL is the annual activity level of the first calendar year of operation after the start of normal operation. If that start is later than the end of the baseline period, the HAL is determined based on the first full year of operation (Article 15(7)).
- **(Annual) Activity Level (AAL or AL):** Article 15(3) to (6) indirectly defines the different activity levels.

- For product benchmarks, the annual activity level is the amount of product as defined in Annex I of the FAR for this benchmark, produced during the calendar year. In some cases (defined by Annex III of the FAR) further correcting parameters are required to determine the AL of each year as well as the HAL. Section 6.8 of this document provides more information (including step-by-step guidance).
 - For heat benchmark and the district heating sub-installations, the AAL is the amount of eligible measurable heat. Section 6.12 of this document gives step-by-step guidance for determining the eligible amounts.
 - For fuel benchmark sub-installations the annual energy content of the eligible fuel quantities gives the AAL. Step-by-step guidance is given in section 6.13.
 - For process emissions sub-installations the annual eligible emissions are identical to the AAL. Step-by-step guidance is given in section 6.14.
 - **Heat, measurable heat, net measurable heat:** In the FAR heat is generally considered as a benchmark-able “product”. However, only heat that is “measurable” is of concern from a monitoring point of view, since other types of heat are handled based on the energy content of the corresponding fuels. “Measurable heat” is defined in the FAR (Article 2(7)) as “a net heat flow transported through identifiable pipelines or ducts using a heat transfer medium, such as, in particular, steam, hot air, water, oil, liquid metals and salts, for which a heat meter is or could be installed”. Due to the requirement that the heat flow must be determined as a “net” amount, monitoring has to take into account the enthalpy of the heat medium delivered from the heat production unit (boiler house, CHP unit, heat exchanger for heat recovery, etc.) to the heat consumer³⁴ minus the enthalpy contained in the heat medium returned to the heat producer. If the medium is not completely returned to the producer, appropriate assumptions have to be made to make the heat consumption process comparable. More information on monitoring requirements for measurable heat is given in section 6.9. Guidance on allocation rules relating to cross-boundary heat flows is provided in Guidance document No. 6.
- Note:** This series of guidance documents uses the terms “heat”, “measurable heat” and “net measurable heat” as synonyms, i.e. the different phrases are only used for better readability. It is not intended to differentiate between “net” and “other” measurable heat.
- **District heating:** Article 2(4) of the FAR defines: “‘district heating’ means the distribution of measurable heat for the purpose of heating or cooling of space or of production of domestic hot water, through a network, to buildings or sites not covered by EU ETS with the exception of measurable heat used for the production of products and related activities or the production of electricity”. This definition is required to distinguish this heat use from other non-carbon leakage heat uses, because Article 10b(4) of the EU ETS Directive provides a different multiplier for allocation to that heat starting in 2026.
 - **Cooling:** Heat in general can be used to drive absorption cooling processes, and cooling can be distributed via networks just like heat, including in public district cooling networks. Following the logic of measurable heat to consider it the difference of enthalpy between delivered and returned medium, cooling would have to be considered as negative heat

³⁴ Depending on the situation, the “consumer” can be a process within the installation, in the same or another sub-installation, or outside the installation.

delivery. However, there are many difficulties associated with such an approach. Therefore, the FAR include a clear rule in section 7.1 of Annex VII: *“Where heat is used to provide cooling via an absorption cooling process, that cooling process shall be considered as the heat consuming process.”* This means that there is no need for further consideration of heat or cooling delivered to consumers downstream of the cooling process. Consequently, this guidance document does not deal with cooling in particular. However, the reader should keep in mind that production of cooling should be considered a self-standing process for heat consumption, and such heat consumption may require monitoring.

- **“Import” and “export”** of materials and fuels, heat, electricity or waste gases are terms widely used in the FAR as well as this document and can relate to both installation and sub-installation level. As there is no further explanation given in the FAR, it is best to understand these terms as straightforwardly as possible: It has been discussed in section 4.1 that sub-installations are system boundaries of a mass and energy balance. Therefore, an import is basically everything that enters those system boundaries, and an export is everything that leaves the system boundaries. Sections 4.2 and 7.3 give further insight to the relevance of various imports and exports for the purpose of attribution of emissions to sub-installations. This purpose also explains why practically every import and export from a sub-installation may require monitoring. Note that in case of heat imports and exports there is an additional need to distinguish the EU ETS status of connected installations, and in the case of exports to also distinguish district heating, CL and non-CL use.
- **Waste gases**³⁵: Certain gases to which specific allocation rules apply. Those are gases which contain combustible carbon and are therefore a borderline case exhibiting certain properties of fuels, but also of process emissions, and are often transferred between (sub-)installations. It is a term used exclusively by the FAR for distinguishing those gases from all other kinds of flue gases or off-gases. Sections 4.2 and 7.3 provide some insight to the treatment of waste gases. More information is given by guidance document No. 8.
- **Flaring, safety flaring**: Flaring means a process in which (gaseous or liquid) fuels or process gases are disposed of by burning without use of the contained energy. There are two purposes of flaring: Either there is no other use for the fuel or the energy, or there would be a safety problem (e.g. danger of explosions) if the fuel or gas is not burned as quickly as possible. The latter purpose is “safety flaring”³⁶. Since different allocation rules apply to safety flaring than for other types of flaring, operators will have to determine which type of flaring takes place at their installations, if any, and will have to monitor the related waste gas emissions separately.

³⁵ FAR Article 2(11): *“‘waste gas’ means a gas containing incompletely oxidised carbon in a gaseous state under standard conditions which is a result of any of the processes listed in point (10), where ‘standard conditions’ means temperature of 273,15 K and pressure conditions of 101 325 Pa defining normal cubic metres (Nm³) according to Article 3(50) of Commission Regulation (EU) No 601/2012.”*

The said point (10) is the definition of the process emissions sub-installation, and lists processes such as the reduction of metal compounds or ores, carbonate decomposition, chemical syntheses other than for a primary purpose of generating heat, etc.

³⁶ The FAR defines in Article 2(13): *“‘safety flaring’ means the combustion of pilot fuels and highly fluctuating amounts of process or residual gases in a unit open to atmospheric disturbances which is explicitly required for safety reasons by relevant permits for the installation.”*

5 THE MMP

5.1 The MMP content

The approved monitoring methodology plan is the most important document for every installation participating in the EU ETS and applying for free allocation pursuant to Article 10a of the Directive. Like the monitoring plan under the M&R Regulation, it should establish the “user manual” for the operator’s tasks of monitoring and data collection. Therefore, it should be written in a way that allows all, particularly new staff to immediately follow the instructions. It must also allow the CA to understand quickly the operator’s monitoring activities. Finally, the MMP is the guide for the verifier against which the operator’s baseline data report is to be judged.

For serving as such a source of understanding, Article 8(1) of the FAR requires in particular that the MMP contains *“a description of the installation and its sub-installations, the production processes and a detailed description of monitoring methodologies and data sources. The monitoring methodology plan shall comprise a detailed, complete and transparent documentation of all relevant data collection steps”*. This requirement is supplemented by Annex VI, point (1)(c), which requests *“a flow diagram and a plan of the installation which allow an understanding of the main material and energy flows”*. It is advisable that such diagrams uses unique designators (names, abbreviations) for every relevant physical unit and measuring instrument or sampling point, such that the rest of the MMP can clearly refer to them³⁷.

The MMP has to ensure that for every data item required in the baseline data report, the MMP has explained how the data is obtained. As has been outlined in chapter 4.7, basically two groups of data need to be covered: Firstly “everything that is needed to determine the annual activity levels of each sub-installation”, and secondly “everything that is needed to determine the attributed emissions of each sub-installation”. The overall installation-level data also has to be provided. Combined these requirements can be expressed as “everything that is needed to monitor each individual data set listed in Annex IV of the FAR”.

Typical elements of an MMP include instructions for the following activities of the operator (applicability depends on the specific installation’s circumstances):

- Data collection (metering data, invoices, production protocols, etc.);
- Sampling of materials and fuels;
- Laboratory analyses of fuels and materials;

³⁷ Point (1)(d) of Annex VI of the FAR requires: *“A diagram which contains at least the following information:*
– *The technical elements of the installation, identifying emissions sources as well as heat producing and consuming units;*
– *All energy and material flows, in particular the source streams, measurable and non-measurable heat, electricity where relevant, and waste gases;*
– *The points of measurement and metering devices;*
– *Boundaries of the sub-installations, including the split between sub-installation serving sectors deemed to be exposed to a significant risk of carbon leakage and sub-installations serving other sectors, based on NACE rev. 2 or PRODCOM”*.

- Maintenance and calibration of meters;
- Description of calculations and formulae to be used, including for correlations and other estimation methods, where applicable;
- Internal control activities for quality control and quality assurance;
- Data archiving (including protection against manipulation and retention for specified time periods);
- Regular identification of improvement opportunities.

However, MMPs must be drafted carefully, so that administrative burden is minimised. Since the MMP is to be approved by the competent authority, it goes without saying that changes to the MMP are only allowed with the consent of the CA. The FAR reduce the administrative efforts here by following the approach already known from the MRR:

- Only changes which are “significant” need the approval by the CA (Article 9 of the FAR, see section 5.4 of this document);
- Data collection activities which are not crucial in every detail, and which by their nature tend to be frequently amended as found necessary, may be put into “written procedures”, which are referenced and described³⁸ briefly in the MMP (see Article 8(3) of the FAR), but the detail of which are not considered part of the approved MMP. The relationship between MMP and written procedures is the same as for MRR purposes. For related guidance therefore please refer to section 5.4 of MRR Guidance Document No.1.

Because of the importance of the MMP, the Commission has provided electronic templates. Some Member States provide customised templates based on the Commission’s templates, other Member States use a dedicated (usually web-based) electronic reporting system. Before developing an MMP, operators are therefore advised to check their competent authority’s website or make direct contact with the CA to find out the specific requirements for submitting an MMP. National legislation may also state specific requirements, such as the need to obtain MMP approval before submission of the first NIMs baseline data report.

5.2 Developing the MMP

When developing a monitoring methodology plan, operators should follow some guiding principles:

- Knowing in detail the situation of their own installation, the operator should make the monitoring methodology as simple as possible. This is achieved by attempting to use the

³⁸ In order to limit the administrative burden, the FAR require according to Article 8(3) only that the operator includes a “reference” to the procedure in the MMP, while the MRR requires a “description” of the procedure in the MP. However, the MMP template contains the option to include a description for the procedures, too. This should help to avoid the situation that the CA has to ask for the full documentation of the procedure in too many cases. Operators are therefore advised to make use of these description fields in the MMP.

most reliable available data sources, robust metering instruments, short data flows, and effective control procedures³⁹.

- Operators should imagine their baseline data report from verifier’s perspective. What would a verifier ask about how the data has been compiled? How can the data flow be made transparent? Which controls prevent errors, misrepresentations, omissions?
- Because installations can undergo technical changes over the years, MMPs must be considered living documents to a certain extent. In order to minimise administrative burden, operators should be careful which elements must be laid down in the MMP itself, and what can be put into written procedures supplementing the MMP⁴⁰.

The methodology report used for the third phase NIMs data submissions is a useful starting point for selecting data sources for each data set at this stage. If the MS has required the operator to have a procedure established to monitor activity levels of sub-installations for the purpose of allocation changes in the third phase⁴¹, this procedure may provide further data sources. However, operators should keep in mind that these two earlier approaches have limitations: Firstly, in the third phase of the EU ETS, attributed emissions were not to be reported to the CA. Secondly, the installation may have changed in the meantime, and even better data sources may have become available. Furthermore, some allocation rules have changed and may require different data than in the third phase (e.g. the new district heating sub-installation). Finally, unlike in the third phase, the legislation now contains rules for which data sources are admissible (and where they are considered to sit on the accuracy hierarchy, see section 4 of Annex VII of the FAR), and these rules must be taken into account.

Developing an MMP will usually be more demanding than development of the MP under the MRR, as the number of data sets to be monitored is generally higher. Due to the need to split the installation into sub-installations, the possible number of situations that need decisions is also higher. Therefore it is impossible to provide here a one-size-fits-all approach for developing the MMP. However, some general advice can be given. Firstly, the systematic (high level) approach is:

- Determine which sub-installations are relevant:
 - Check the installation’s products against Annex I of the FAR to find out which product benchmarks apply;
 - Follow the systematic approach outlined in sections 6.12 to 6.14 of this document for identifying further sub-installations.
- Determine which data sets need monitoring and reporting (for an example see section 4.5). A first screening should in particular include the questions:
 - Are measurable heat flows relevant at all?

³⁹ FAR Article 8(2): “Based on the risk assessment in accordance with Article 11(1) and control procedures referred to in Article 11(2), when selecting monitoring methods, the operator shall give preference to monitoring methods that give most reliable results, minimise the risk of data gaps, and are least prone to inherent risks, including control risks.”

⁴⁰ It should be noted that the verifier will review both the MMP and any subsidiary procedures during verification.

⁴¹ Such procedure was optional under Article 12(3) of the MRR, and Article 24 of the third phase allocation rules (“CIMs”, Decision 2011/278/EU).

- Are waste gases or transfer of CO₂ (whether pure or as inherent CO₂ within the meaning of the MRR) relevant?
- Is flaring relevant, and if so, non-safety flaring?
- Is monitoring of electricity relevant? (Is there production of electricity? Are there sub-installations with exchangeability of fuels and electricity in line with Annex I of the FAR?)

The more negative answers to the above questions, the simpler the MMP will be.

- Determine for each relevant data set the sources to be used (rules therefore are explained in chapter 6):
 - The data source for historical data;
 - The primary data source for monitoring data; and
 - The corroborating data source.
- Establish the internal control system (risk assessment, control measures and procedures) and further procedures required, including establishing in particular the responsibilities for M&R, for QA/QC measures, for filing, IT systems, etc.

As it may not always be straightforward to decide which data sets are relevant, the operator may start by trying to fill the Commission's baseline data report template, and note down for each data entry:

- What sources are available for the historical data?
- What data sources are available in the future for this data set?

Alternatively, the operator may use the Commission's MMP template as a checklist for asking these two questions. However, for more complex installations it is advisable to first follow the step-by-step instructions for identifying the relevant sub-installations and data needs, as outlined in sections 6.12 to 6.14 of this document.

The next step is then to select the sources representing the highest accuracy as described in section 6.6. After having selected the data sources, the operator should describe them as well as their use (i.e. the formulas to be used).

Having now described all data sources to be used, the operator has to put down in writing the data flow from primary data to final (annually aggregated) data in the baseline data report for each data set. This is usually done in the associated procedures. Together with the data flow, the internal control system is to be defined (see section 5.5). For learning about procedures in general, section 5.4 of MRR GD 1 is a good starting point. That GD 1 also briefly explains the role of the data flow and control procedures in its section 5.5 (MRR GD 6 gives even more information and examples).

Finally, the operator may want to perform a quality check on the MMP. For this purpose, the last paragraph of Annex VI of the FAR may be the guideline: *“The descriptions of the methods used to quantify parameters to be monitored and reported shall include, where relevant, calculation steps, data sources, calculation formulae, relevant calculation factors including unit of measurement, horizontal and vertical checks for corroborating data, procedures underpinning sampling plans, measurement equipment used with reference to the relevant diagram and a description how they are installed and maintained and list of laboratories engaged in carrying out relevant analytical procedures. Where relevant, the description shall*

include the result of the simplified uncertainty assessment referred to in Article 7(2)(c). For each relevant calculation formula, the plan shall contain one example using real data.”

It is useful to keep the above requirement in mind when completing the MMP template. In order to keep its size manageable, the description fields in the template are kept generic and short. However, all of the above information has to be added, either in the free text fields, or in separate attached files.

5.3 Approval of the MMP

As the MMP is the crucial instrument for ensuring the consistency and quality of FAR-related data, it has to be approved by the competent authority. The CA will check it against criteria such as:

- Is the MMP complete? Are the required descriptions and diagrams attached? Are all data sets required for the baseline data report covered (including, where relevant, description of the different data sources for historical and monitoring data)?
- Transparency: Are the description of the installation, its processes and sub-installations and the attached diagrams sufficiently clear for understanding?
- Is the MMP compliant with the requirements set out by the FAR? In particular, are data sources of highest available accuracy used, and if not, are the deviations sufficiently explained and relevant evidence attached (evidence for unreasonable costs, technical feasibility, or simplified uncertainty assessments, as relevant)?

5.3.1 Timing

According to Article 4 of the FAR, the obligation for the operator to monitor the relevant data starts immediately with the entry into force of the FAR (*placeholder for date*). However, at this time operators will not have their final MMPs available, because some may have waited for the FAR to be adopted, and for their language version of the Commission’s or their MS’s version of the MMP template. Therefore, operators may have to treat the first part of 2019 like the data collection of historical data, and document this fact in related data reports.

The MMP should be approved by the CA as soon as possible in order to ensure the highest possible quality of the data used for future submissions of allocation data. Therefore, operators should submit their MMPs to CAs as quickly as possible. The deadlines provided by the FAR are as follows:

- As general rule the MMP should be submitted for approval together with the first baseline data report. Article 4(1) of the FAR sets 30 May 2019 as deadline, and MS may choose to give another deadline which may be between 30 April and 30 June that year).
- However, according to Article 8(4) of the FAR, MS may require that the MMP is approved *before* the submission of the first baseline data report. In those MS a much stricter deadline will apply. Operators should therefore ensure they know the deadline applicable in their MS.

- According to Article 5(2) of the FAR, new entrants shall submit their MMP together with their application for free allocation. The latter can only be finalised after the first calendar year after the start of normal operation. For example, if the installation starts normal operation on 3 March 2020, the first full calendar year is 2021, and the application can be submitted in 2022. However, Article 6 applies to all installations, i.e. the monitoring requirement based on an MMP applies to new entrants from the first day of operation of the installation and the MMP needs to be approved by 31 December 2020 or – if this is not possible – as soon as possible thereafter.
- If an operator has renounced free allocation for an earlier allocation period, but decides to apply for free allocation again for the next allocation period, Article 8(5) requires the MMP be submitted for approval at least 6 months before the time limit for submission of the application for free allocation. Thus, if an operator renounces free allocation for the period 2021-25, but wants to apply again for the period 2026-2030, the data must be submitted by 30 May 2024 (± 1 month), and the MMP must be submitted by 30 November 2023 (± 1 month).

5.3.2 Different focus of MMP in the first NIMs round and thereafter

Due to the fact that the development and approval of the MMP happen later than when some of the relevant data are generated, the following situations⁴² may occur:

1. Generation of data after the MMP has been approved by the CA. In this case it can be safely assumed that the monitoring methodology is based on data of highest accuracy in line with the FAR's requirements, or that at least the data sources used are justified⁴³ and accepted by the CA. Furthermore, it can be assumed that in this situation the operator has sufficient safeguards in place to avoid data gaps, and methods for reasonably closing the gaps with surrogate data, should data gaps occur.

In this situation the operator should adhere to the approved MMP.

2. Generation of data where the operator already has an MMP, but it is not yet approved. The situation is similar where an MMP update is necessary or already submitted to the CA, but not yet approved.

In the first situation (i.e. before the first MMP approval by the CA) the operator should apply the MMP, assuming it will be approved. If the CA concludes that other, more accurate, data sources should be used, the operator shall change the monitoring approach to comply with the approved MMP. However, for the period before MMP approval, the monitored data will become "historical data", and should be treated as outlined under point 3 below, unless better data sources are also available. The operator should always ensure that the MMP is clear on which data sources are used for which periods of time.

For the second situation (update of the MMP) see section 5.4 below.

⁴² For the terms "historical data" and "monitoring data" please see the box on page 33.

⁴³ Note that in line with the improvement principle (Article 9(1) of the FAR), the operator has to check regularly whether better data sources can be used, i.e. e.g. if unreasonable costs are not incurred anymore in case of a better method. "Better" here means "higher up in the hierarchy presented in section 4 of Annex VII of the FAR".

3. The data are “historical data”, i.e. generated at a time when the operator does not have an MMP yet, but due to his knowledge of the data requirements in the 3rd EU ETS phase has already monitored some or all of the required data. This may be the case if the operator had a procedure pursuant to Article 12(3) of the MRR in place for monitoring of activity level data. As a basic assumption, such a monitoring method will be a continuation of what has been established in the methodology report for the 3rd phase NIMs, or built on better (more reliable) methodologies. However, such data does not necessarily comply with the FAR’s requirement of most accurate available data sources.

This situation is similar to purely historical data (see point 4). However, as the operator has actively monitored at least some of the required data sets (in particular the activity levels), data generated in this way are in most cases “better” (more reliable, higher up in the hierarchy according to section 4 of Annex VII of the FAR) than other types of historical data. Therefore, such data will be preferred for historical data.

4. “Purely historical” data: This term refers to data that were generated while the operator was not expecting that such data would be required for reporting for FAR purposes. I.e. these are data that were collected for some other purposes, e.g. process control, quality management of various kinds, technical reasons (e.g. process optimisation), or invoicing or other financial purposes (e.g. allocation of heat amounts to business units or individual products’ production costs for internal accounting). In this situation sampling points or measuring instruments will often not comply with FAR requirements (e.g. they will not be placed in accordance with sub-installation boundaries), or no measuring instruments are available at all. Often such data will be based on estimation methods. Since these data have been generated in the past, the operator cannot collect better data (e.g. by installing better meters), but has to use the data available. However, where there is more than one data source, operators should assess which of the existing data is most accurate, most reliable, has the fewest data gaps, in short: which can be trusted most.

5. Completely missing data: It cannot be fully excluded that in some situations an operator does not find in the installation’s files any data for a specific data set required by the FAR (e.g. if internal source streams never needed to be monitored, or if never before there was a need to distinguish safety flaring from other types of flaring, etc.).

In such situations the operator will have to develop a reasonable estimation method for filling the gap for historical data, and – if this estimation does not satisfy the requirement of most accurate available data sources for future monitoring – will have to develop and/or apply a suitable other method for monitoring the required data going forwards (e.g. by installing appropriate measuring instruments at appropriate places in the installation).

Note that some MS may decide to require operators to treat the backward and forward-looking parts as separate versions of the MMP, although here it is assumed that both aspects can be handled within only one document, in particular where the data sources do not differ strongly for both cases: Taking the above categorisation of data into account, MMPs will be developing over time. The first issue an operator has to solve is to completely establish the part which refers only to historical data, i.e. the first baseline period covered by the FAR (2014-2018). Next, at the time the MMP is submitted to the CA for approval (i.e. together with the application for free allocation, or earlier, if the MS so requires), the operator has to also have completed the forward-looking part. Finally, as soon as the operator can be sure, that no historical data will be required any more, he might decide update the MMP to remove all (now

non-relevant) backward-looking elements from the MMP in order to keep it lean and easier to manage. This would be the case after submission of the second baseline data report (in 2024), which covers data from 2019 onwards. As MMPs have to be approved by 31 December 2020, no historical data can be relevant after that date⁴⁴. New entrants – if they have submitted their MMP for approval before start of operation – will also not have to include methods for historical data in their MMPs.

5.3.3 Verification without approved MMP

Guidance Document 4 of this series (“Verification of FAR Baseline Data Reports and validation of Monitoring Methodology Plans”) explains in sections 2.2 and 6.2 that the verifier will have to validate the MMP during verification of the baseline data report, if it has not yet been approved by the CA. This has an impact on the verifier’s efforts and therefore on verification costs. However, the focus of this validation will be on checking the FAR compliance of those elements of the MMP that relate to the data in the baseline data report being verified, i.e. the backward looking historic data related methodologies and procedures. As soon as the CA has approved the MMP, the situation will be like for annual verifications of emissions data: Like the approved MP under the MRR, the approved MMP under the FAR is the basis for verification. The relevant requirements are included in the AVR⁴⁵.

For more information on verification in general, the reader should refer to the suite of MRVA guidance material on the Commission’s MRVA website⁴⁶, and in particular EGD I (“AVR Explanatory Guidance”).

5.4 The improvement principle – approval of MMP updates

The monitoring methodology plan must always correspond to the current nature and functioning of the installation. Where the practical situation at the installation is modified, e.g. because products (the sub-installations), technologies, processes, fuels, materials, measuring equipment, IT systems, or organisational structures (i.e. staff assignments) are changed (where relevant for the FAR monitoring), the monitoring methodology must be updated (Article 9 FAR)⁴⁷. The MMP must also be updated as a consequence of the requirement to

⁴⁴ The exception would be operators who have renounced free allocation, but decide to apply for free allocation in later phases.

⁴⁵ For reference see Annex B, section 8 of this document.

⁴⁶ See footnote No. 1.

⁴⁷ Article 9(2) lists a minimum of situations in which an MMP update is mandatory:

“(a) new emissions or activity levels occur due to new activities carried out or due to the use of new fuels or materials not yet contained in the monitoring methodology plan;
(b) the use of new measuring instrument types, new sampling or analysis methods or new data sources, or other factors, lead to higher accuracy in the determination of reported data;
(c) data resulting from the previously applied monitoring methodology has been found incorrect;

improve the monitoring methodology continually, and for taking into account the verifier's recommendations for improvement.

Depending on the nature of the changes, one of the following situations can occur:

- If an element of the MMP itself needs updating, one of the following can apply:
 - The change to the MMP is a significant one. The updated MMP has to be notified to the CA without undue delay and to be approved by the CA. In case of doubt, the operator has to assume that the change is significant.
 - The change to the MMP is not significant. Such changes have to be notified to the CA, but not approved. To reduce administrative burden, CAs may allow the operator to submit these changes cumulatively by 31 December of the reporting year.
- An element of a written procedure is to be updated. If this affects neither the (optional³⁸) description of the procedure in the MMP nor the actual quality of the monitoring methodology or the control procedures, the operator will carry out the update under his own responsibility without notification to the competent authority.

It is considered best practice for the operator to make use of a "change log", in which all non-significant changes to the MMP and to procedures are recorded, as well as all versions of submitted and approved MMPs. The operator must implement a written procedure for regular assessment of whether the monitoring plan is up to date (FAR Article 9(1) and point 1(g) of Annex VI).

For the period between update of the MMP and actual approval by the CA the FAR do not give as detailed instructions on how to handle the situation as the MRR does. However, operators are advised to follow the same principles (see also section 5.6 and 5.7 of MRR guidance No. 1):

- Operators should use the current MMP, assuming that it complies with the FAR and that it will be possible for the CA to approve it.
- However, if there are alternative data sources available (e.g. in line with a previously approved MMP as well as those contained in the new one), the operator should continue using (i.e. keeping records of) both data sources until the CA approves the updated MMP.
- After approval of the updated MMP the operator may discard the data not in line with the latest approved MMP, if different data sources were used in parallel as consequence of the MMP update.
- The operator shall keep complete documentation of all versions of the MMP submitted and approved, including a record of the applicability dates of each version (Article 9(6) FAR). This is needed to allow a fully transparent audit trail, including for the purposes of the verifier.

(d) the monitoring methodology plan is not, or no longer, in conformity with the requirements of this Regulation;

(e) it is necessary to implement recommendations for improvement of the monitoring methodology plan contained in a verification report."

5.5 The control system

As MRR GD 1 states: *“Monitoring [...] is more than just reading instruments or carrying out chemical analyses. It is of utmost importance to ensure that data are produced, collected, processed and stored in a controlled way. Therefore, the operator must define instructions for ‘who takes data from where and does what with the data’. These ‘data flow activities’ [...] form part of the monitoring plan (or are laid down in written procedures, where appropriate [...]). A data flow diagram is often a useful tool for analysing and/or setting up data flow procedures. Examples for data flow activities include reading from instruments, sending samples to the laboratory and receiving the results, aggregating data, calculating the emissions from various parameters, and storing all relevant information for later use. As human beings (and often different information technology systems) are involved, mistakes in these activities can be expected.”*

What is said here about the MP also applies to the MMP. It is therefore no surprise that the requirements for an effective internal control system for allocation data as given by Article 11 of the FAR strongly adhere to what is required by MRR Articles⁴⁸ 57 to 64. Therefore, it does not seem necessary to duplicate that guidance for this purpose. The reader is invited to learn more about risk assessments and control measures for mitigating relevant risks from the following sources⁴⁹:

- MRR Guidance document No. 1, section 5.5;
- MRR guidance document No. 6 (“Data flow activities and control system”)
- MRR guidance document No. 6a (“Risk assessment and control activities – examples”)
- A tool for the risk assessment found on the same web site.

Since the requirements of the FAR are very similar to those of the MRR, operators are advised to use the same procedures and control measures as developed for the MP and extend them to all relevant data sets of the MMP, where possible. Such an approach will reduce the possibilities of errors and will keep the control system relatively simple, minimising the need for additional training, and ultimately simplifying the verification of FAR data by the synergies between MP and MMP.

5.6 Avoiding and closing data gaps

5.6.1 Temporary deviations from the approved MMP

Article 12(1) deals with the situation where the monitoring methodology approved in the MMP can *temporarily* not be used. This applies e.g. if a measuring instrument fails and needs to be replaced or repaired. In such case, the following applies:

⁴⁸ The Article numbers here refer to the MRR in the version of Regulation (EU) 601/2012.

⁴⁹ See footnote No. 1 for where to find the MRR guidance material.

- The operator shall take all necessary measures to restore the situation as approved in the MMP. Although not explicitly stated in the FAR, the FAR logic would imply that if such restoration is technically not feasible or would incur unreasonable costs, the operator has to select a new data source in line with the hierarchy provided in section 4 of Annex VII of the FAR, and submit a corresponding MMP update to the CA for approval without undue delay.
- As (to the extent not incurring unreasonable costs) the MMP should contain a “corroborative data source” for each data set (which is of lower accuracy than the primary data source, but nevertheless already approved by the CA), the operator shall use that corroborative data source instead of the primary data source for the period of the primary source’s unavailability.
- If no corroborative data source has been approved as part of the MMP, the operator has to select another available data source according to the generic hierarchy of data sources.

In this latter case, Article 12(3) requires the operator to modify the MMP (i.e. to include the new corroborating data source) and to obtain the CA’s approval. Furthermore, the operator shall assess whether and how the control activities have to be updated, and to include a procedure for avoiding such deviation in the future.

5.6.2 Missing data

Where a data gap is due to missing data of the primary data source, the operator should use the corroborating data source for the period of missing data. However, if even those data are missing, or where no corroborating data source has been defined in the approved MMP, Article 12(2) requires the operator to use an appropriate estimation method for determining *conservative* surrogate data for the respective time period and missing parameter. That Article allows methods “based on best industry practice, recent scientific and technical knowledge”. The term “conservative” is further explained in section 5.6.3.

Data gaps have to be listed in an Annex to the baseline data report⁵⁰, and due justification has to be provided for each data gap.

In the same way as for temporary deviations from the MMP, Article 12(3) requires the operator to modify the MMP to avoid data gaps in the future (e.g. by selecting a more reliable primary data source or by improving the data flow activities) and to obtain the CA’s approval. Furthermore, the operator shall assess whether and how the internal control activities have to be updated.

⁵⁰ For the purpose of historical data, it should be considered sufficient to list in the MMP all data sources used. As historical data in general must make use of “available data”, gaps may occur, and estimations will often be required. However, as in such case the estimation method itself is considered a “data source”, “unfillable” data gaps will hardly occur. Therefore, the justifications required for data gaps can be given by a more general description of data availability, instead of giving separate justifications for individual time periods or data sets. Also any safety margins added for ensuring conservativeness of data can be kept moderate.

5.6.3 Conservative approaches

The FAR do not contain a definition of “conservative”. The MRR defines: “‘conservative’ means that a set of assumptions is defined in order to ensure that no under-estimation of annual emissions or over-estimation of tonne-kilometres occurs”. Note that tonne-kilometres are the activity levels for aviation activities to which a benchmark is applied for allocation. Therefore, in the same spirit, a definition for FAR purposes might read as follows:

‘Conservative’ means that a set of assumptions is defined in order to ensure that no under-estimation of a sub-installation’s attributed emissions or over-estimation of its activity level occurs.

There is no simple one-size-fits-all approach to how to make an assumption or estimation method conservative. “Excessively conservative” data should be avoided, as the principle of accuracy means that systematic over- or under-reporting is to be avoided. The Commission has provided a guidance document for MRR and AVR purposes on making conservative estimates for emissions⁵¹. Chapter 4 of that guidance contains a “toolbox” for filling data gaps (examples are given only for emissions), which in principle proposes methods which the FAR would consider correlation methods or estimation methods in general. The toolbox also proposes to add a “safety margin” to ensure that the data is indeed conservative. This can be done e.g. by adding/subtracting 2σ to averages of correlated values, or using the maximum/minimum value of historical measurements, etc. as appropriate in line with the above suggested definition.

⁵¹ GD without number on “Making conservative estimates for emissions in accordance with Article 70 MRR”. For the web link see footnote No. 1.

6 MONITORING RULES

6.1 Overview of FAR monitoring rules

The M&R system of the FAR is more demanding than for annual emissions under the MRR, because there are multiple different kinds of data (not only source streams or emission sources, but also products (quality and quantity), heat (temperature, pressure, saturation, quantity of flow and return flow) and electricity are to be monitored⁵². Furthermore, monitoring at sub-installation level requires more effort than at installation level. Hence operators, verifiers and competent authorities need to acquire additional knowledge.

For balancing these additional requirements and keeping monitoring efforts reasonable, the FAR monitoring rules are kept simpler than for annual emissions monitoring. These simplifications in particular concern the following elements:

- In the FAR, no tiers are defined (unlike in the MRR). However, for the robustness of the monitoring system it is still required that the operator selects “most accurate data sources”. For this purpose, the FAR provide a set of approaches (see section 6.6) and a hierarchy for which approach is preferable, thereby creating a system of “tiers light”.
- There is no categorisation of installations (categories A, B, C, and installations with low emissions) or other data sets (such as major/minor/de-minimis source streams). Therefore, there are fewer rules to be followed.
- For judging the quality of the monitoring approach, there is no mandatory uncertainty assessment. An exception applies only where an operator wants to provide evidence that deviation from the hierarchy of approaches can be justified based on the lower uncertainty of the proposed approach (see section 6.6.3).

Overall the same cost efficiency principle as for the MRR applies, i.e. operators are allowed to use as much as possible monitoring approaches for which the measuring instruments, sampling and analysis methods are already in place. Furthermore the same principle as in the MRR applies to avoid approaches which are technically not feasible or would incur unreasonable costs (see section 6.6.2). However, the improvement principle is also applicable (see section 5.4), although it is less stringent due to the absence of defined minimum tiers.

For developing the MMP and for the monitoring and reporting of data under the FAR, Articles 6 to 12 of the FAR are essential, together with Annex VII (“Data monitoring methods”), Annex VI (“Minimum content of the monitoring methodology plan”), and Annex IV (“Parameters for baseline data collection”, i.e. the content of the baseline data reports). However, in many regards relevant provisions will be found in the MRR (in particular for installation level emissions data, but also on general approaches like risk assessment, control system, use of instruments not under the operator’s control, QA/QC measures, etc.). These should be applied “*mutatis mutandis*” to FAR data, where the FAR themselves do not provide provisions. Furthermore, the AVR for verification purposes and the carbon leakage list Decision also have to be taken into account.

⁵² This complexity is the reason why the term “data set” is often used in the FAR and this guidance, in order to cover all types of different data.

Article 6 of the FAR (Obligation to monitor) has already been discussed in section 5.3.1. Article 7 (Monitoring principles) establishes the basis for the “hierarchy of approaches” which is discussed in section 6.6. Article 8 (Content and submission of the MMP) is discussed extensively in sections 5.1 to 5.3, and Article 9 (Changes to the MMP) is the basis for section 5.4.

Article 10 (Division into sub-installation) is of central importance for the whole benchmarking system of the EU ETS. In this guidance document it is discussed in chapter 4 and in Annex A (chapter 7). Guidance on Article 11 (Control system) is provided in section 5.5, and Article 12 (Data gaps) is dealt with in section 5.6.

Therefore, chapter 6 focusses on Annex VII of the FAR in order to complete the information on the FAR’s M&R provisions and requirements.

6.2 Overarching principles

Article 7(1) sets out the principles of monitoring under the FAR: *“Operators shall determine complete and consistent data and ensure that there are no overlaps between sub-installations and no double counting. Operators shall apply the determination methods laid down in Annex VII, exercise due diligence and use data sources representing highest achievable accuracy pursuant to section 4 of Annex VII.”* Thus, two aspects can be considered as cornerstones for FAR monitoring:

- Data must be complete (without double counting) and consistent, hence this document gives ample space to this topic (in particular the detailed rules presented in Annex A, section 7.3 are essential in this regard);
- Accuracy is key. Operators must exercise due diligence to achieve this goal.

A first step to complying with these principles is that the FAR here require the operator to use only monitoring methods laid down in Annex VII. However, therein lies a dilemma. Like any legislation the FAR have been written with an attempt to keep them manageably concise and brief. Therefore, many requirements are formulated using general wording (see section 4.7). However, each of the ca. 10 000 installations in the EU ETS is different, and it is virtually impossible to provide detailed monitoring rules covering all of these situations⁵³. The dilemma is solved by section 3.1 of Annex VII of the FAR. It provides an overarching principle (in line with what is known from the MRR):

- Where Annex VII does not explicitly provide an applicable monitoring method, the operator has to apply “a suitable method” approved by the CA (i.e. the operator has to develop a method and request the CA’s approval).
- Such a tailored method is considered “suitable” (i.e. can be approved by the CA), if any metering, analyses, sampling, calibrations and validations for the determination of the specific data set are carried out by applying methods

⁵³ This is why the MP and MMP have to be developed by the operator for their installation-specific situation, because “general applicable rules” in legislation alone have proven insufficient, in particular for ensuring consistency of time series and for being a basis for verification.

- based on corresponding EN standards;
- Where such standards are not available, the methods shall be based on suitable ISO standards or national standards.
- Where no applicable published standards exist, suitable draft standards, industry best practice guidelines or other scientifically proven methodologies shall be used, limiting sampling and measurement bias.

In short, preference is given to EN standards or other “proven best practices”. The bottom line is that methods must be scientifically justifiable. In order to avoid arbitrary development of monitoring approaches, such self-developed methods are ranking lowest in the hierarchy of approaches for choosing data sources of highest achievable accuracy (see section 6.6).

6.3 Installation level data and split to sub-installations

One of the most fundamental issues in FAR monitoring and reporting is the assigning of data to sub-installations, which inherently requires monitoring at sub-installation level. This is more demanding than focussing only at installation level as the MRR does. For the latter there is often only one measurement point per source stream required. Under the FAR, the number of necessary measurement points increases with the number of sub-installations, i.e. at least n measurement points are required per parameter, with n being the number of sub-installations where the parameter under consideration is relevant.

FAR Annex VII section 3.2 contains the fundamental rules for splitting data into sub-installations. Point 2 of that section contains rules for situations where measuring instruments are available for carrying out the data split. Point 1 of that section contains the rules for situations where no meters are available or where their readings do not give direct results for the required parameter. It is further explained in section 6.3.2.

6.3.1 Use of sub-meters

One of the most common situations at EU ETS installations is that a fuel is used in several physical units of the installation. This situation is chosen for its simplicity here to illustrate the basic principles of splitting data into sub-installations. However, similar approaches apply to all kinds of materials and energy flows, e.g. the attribution of heat or electricity consumption to sub-installations.

In the example natural gas consumption is determined using continual metering. In EU ETS installations there is often one central measurement (a main gas meter) where the gas is entering the installation, and further sub-meters at individual process units. The quality of the meters may differ. The main meter is the one of highest importance for economic reasons, and both the operator and the gas supplier are interested in accurate measurement results. In many MS such meters are therefore subject to National Legal Metrological Control (NLMC). But also where this is not the case, the owner of the instrument (often the gas supplier or grid operator) will ensure regular maintenance and calibration of the instrument (including the instruments for temperature and pressure compensation). For cost reasons the sub-meters are often of lower accuracy (higher uncertainty). Furthermore, there may be some units which

have no separate meters, or the locations of the meters may not coincide with the boundaries of the sub-installations. FAR Annex VII section 3.2 point 2 contains the rules required for such cases, as explained using the example below.

The example (see Figure 4) deals with a fictitious installation where natural gas is used in three physical units serving two sub-installations. Units 1 and 2 belong to sub-installation 1, and unit 3 belongs to sub-installation 2. The figure shows different situations that can be found in typical installations:

- Case 1: In this simple, cost effective situation the total amount of gas is metered by the measuring instrument MI_{total} . This instrument is also used in the approved MP under the MRR (as discussed in section 6.5, this situation is considered highest available accuracy for FAR purposes, and therefore has to be used by the operator for FAR data, too). The second measuring instrument (MI-1) relates directly to sub-installation 1. Its results should be used for FAR purposes⁵⁴. The gas quantity for sub-installation 2 is simply calculated as difference between the readings of MI_{total} and MI-1⁵⁵.
- Case 2: This is another simple case with two meters for two sub-installations. As there is no meter for the total gas entering the installation, it is to be assumed that the approved MP under the MRR requires the operator to determine the gas consumption for calculating the installation-level emissions as sum of the readings of those two meters. Consequently, both meters are complying with point (a) of section 4.4 of FAR Annex VII and can be used directly for FAR purposes.
- Case 3: Although here two meters are found, they are located in a way that they cannot be used for determining the sub-installation-level gas consumption. The operator will have to establish a situation more like that in case 1, i.e. the operator should install a sub-meter either at a position like MI-1 or like MI-2 in case 2, and then continue as under case 1. The operator must apply another method for determining the sub-installation gas consumption for the purpose of historical data. This can be correlations or estimation methods as discussed in section 6.4. For (forward-looking) monitoring data, the operator can avoid installing another meter only if he can demonstrate to the CA that installing another meter would incur unreasonable costs or would not be technically feasible.
- Case 4: In this case the gas consumption is “over-determined”, i.e. there are more measuring instruments than required. In such situation it is often observed that the sum of the sub-meters’ readings (MI-1a, MI-1b and MI-2) differs from the reading of the main meter MI_{total} . As explained above, it is usually assumed that the result of MI_{total} is the most reliable one, i.e. in MRR terms it complies with the highest tier (it exhibits the lowest

⁵⁴ This is in particular true for historical data. However, for future monitoring it may be necessary that the operator provides a justification for its use, or may have to obtain an instrument higher up in the hierarchy provided in FAR Annex VII section 4.4, if the current instrument does not fall under the highest accuracy categories. More information is given in section 6.6.

⁵⁵ Point (2)(b) of section 3.2 of Annex VII of the FAR: “If only one sub-installation’s data are unknown or of lower quality than the data of other sub-installations, known sub-installation data may be subtracted from the total installation data. This method is preferred only for sub-installations which contribute smaller quantities to the installation’s allocation.” The last sentence indicates that the FAR in general prefers direct metering over indirect methods such as this subtraction. Where more than just a “smaller quantity” is to be metered, therefore the preferred approach would involve the installation of an additional meter for sub-installation 2 and to use the reconciliation factor approach described under case 4.

uncertainty), and in FAR terms it represents most accurate available data, because it falls under point (a) of section 4.4 of Annex VII (it is the instrument used under the approved MP under the MRR). Therefore, the sub-installations' data must be adjusted such that their sum is identical to the installation-level data. This is achieved by applying point (2)(a) of FAR Annex VII section 3.2: A "reconciliation factor" is calculated (in this case: Reading of MI_{total} divided by the sum of the readings of the three sub-meters). The readings of the sub-meters are thereafter corrected by multiplying them with that reconciliation factor.

Note: Case 4 assumes that clearly MI_{total} is the best instrument, and the others are of lower quality. This is not always the case. It might as well be that e.g. MI-2 is of considerably higher quality than the other two sub-meters. In this case it would be justified to use the method described in case 1 instead. The instruments MI-1a and MI-1b would then be used only as corroborating data source. FAR Annex VII section 3.2 point 2 doesn't indicate a preference for either approach, i.e. where the operator has enough data sources available, the choice is to be made based on Section 4.4 of Annex VII.

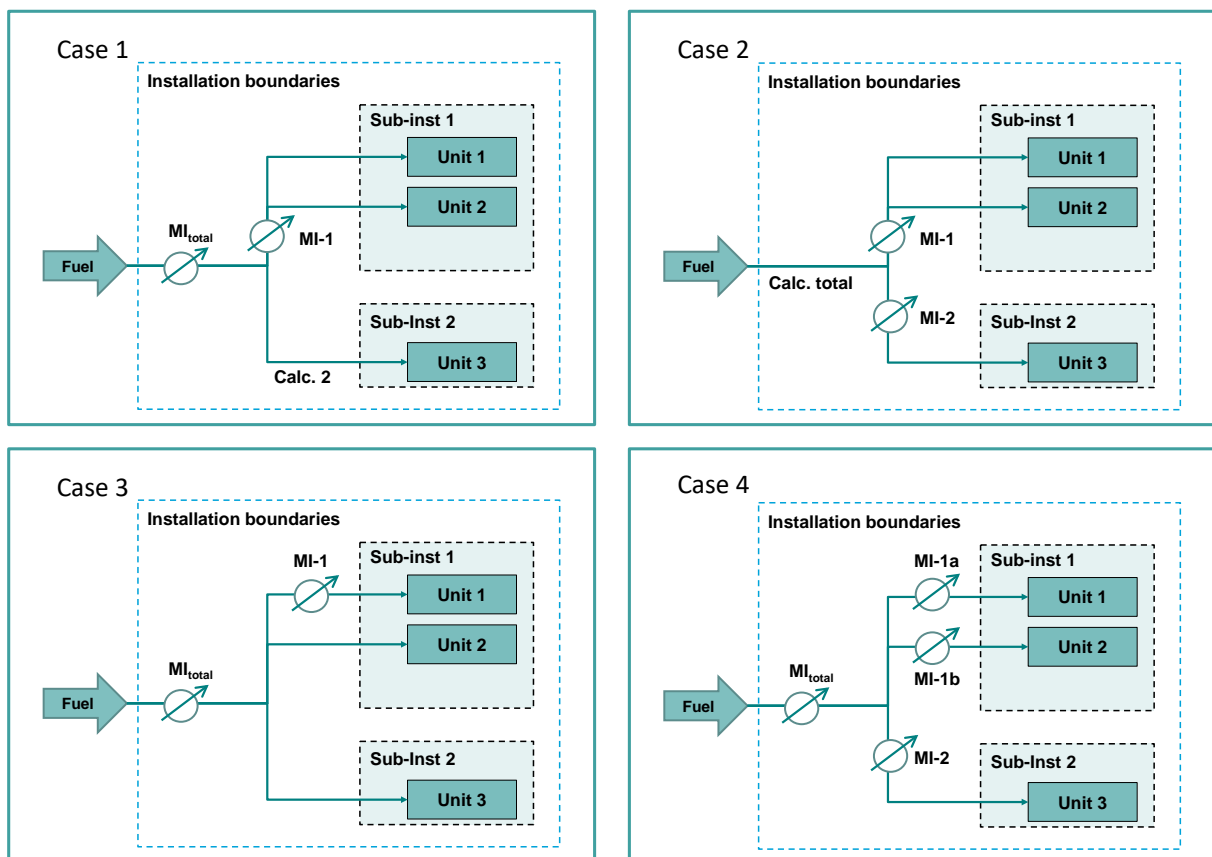

Figure 4: Different cases of metering of a fuel to be split into sub-installations. For explanation of the different cases see main text.

6.3.2 Split into sub-installation without direct metering

As has been seen in the previous example (case 3), sometimes there are no measuring instruments available for splitting data according to sub-installation boundaries. There may even be cases where separate measurement is impossible, because processes take place simultaneously, or within the same physical unit. As mentioned in section 6.2, Annex VII of the FAR does not contain detailed rules for every possible case. However, for narrowing down the range of possible approaches beyond the principle of sound scientific approaches, point 1 of FAR Annex VII section 3.2 provides the following two rules for handling sub-installation splits in the absence of direct measurements:

- Point (a) of that FAR section handles the situation of sequential production within the same “production line” (or physical unit) based on the usage time.

This rule applies e.g. to the lime kiln described in section 4.5, where the same gas meter would serve two different sub-installations, and the data split has to be carried out by time periods (i.e. readings from the gas meter are required every time a switch between sub-installations is performed)⁵⁶. Other common examples are the production of chemicals and some food industries, where different products are produced in batches one after the other using the same equipment, and where it may be necessary to assign (measurable) heat consumption to these products in order to distinguish the CL and non-CL sub-installations.

- Point (b) covers all cases where time periods are not appropriate, i.e. situations where different products are produced simultaneously. This may even include process where the data is in principle not separately measurable, such as heat consumption of chemical reactions where several products result from the same process⁵⁷. A more common situation is that measurable heat has to be attributed to a plethora of production processes and physical units in a complex installation, where it would incur unreasonable costs to install an appropriate number of heat meters.

The rule allows the operator to assign the parameter which is to be split according to sub-installation boundaries (e.g. the amount of measurable heat and the associated emissions) *“based on the mass or volume of individual products produced or estimates based on the ratio of free reaction enthalpies of the chemical reactions involved or based on another suitable distribution key that is corroborated by a sound scientific methodology.”*

Section 6.5 provides examples for the application of these rules.

Note: It may occur that installation’s total data deviates from the sum of the sub-installations’ data when using various methods. The rules of Annex VII section 3.2 (use of difference or reconciliation factor, see section 6.3.1) have to be used to ensure the totals add up to the same value. Of course, it also has to be taken into account that there are some parameters which are not attributed to any sub-installation (see box on page 22).

⁵⁶ One could argue that a clock is a measuring instrument, too. However, in this case the clock is only half the story. The operator also has to set up a methodology for determining the exact time of the switch between sub-installations, i.e. a transition period may have to be attributed to the two sub-installations using reasonably justified assumptions.

⁵⁷ However, this example is of little practical relevance, since some of the product benchmarks for chemicals are defined in a way that they cover the complete relevant product mix (e.g. HVC, aromatics, etc.).

6.4 Direct vs. indirect data determination

The FAR acknowledge that due to the potentially high number of data sets to be determined it will often not be possible (according to technical feasibility and/or unreasonable costs) to install measuring instruments at all locations needed in the installation. The same applies to the appropriate sampling and analyses for all materials involved. Therefore, the FAR distinguish in Annex VII:

- **Direct determination:** This means for determination of quantities (fuels, materials, measurable heat, waste gases, electricity) that there is a measuring instrument available for monitoring which can be read to immediately give the quantity, such as m³ or tonnes of fuel, TJ or MWh consumed, etc.

Direct determination can furthermore mean the use of documents containing values stemming from such direct measurements, e.g. invoices for fuels based on measuring instruments not under the operator's control, or historical data contained in the operator's written documentation or databases.

For the purpose of analyses, direct determination means that the analytical parameter of interest itself is analysed (e.g. the carbon content of a material), while indirect determination would mean that the content of other constituents is analysed and the carbon content is determined by calculating the difference from the total.

- **Indirect determination:** This means the calculation of values based on other quantities which can be directly determined. An example would be the situation described in case 1 of the example in section 6.3.1, where the fuel consumption of sub-installation 2 is calculated (i.e. indirectly determined) as the difference between other values determined by direct measurement (fuel consumption at installation level and for sub-installation 1). An example for analyses is the composition data of burnt quicklime, where the contents of free CaO and free MgO as well as of impurities are determined, and the unreacted CO₂ is determined by difference to 100%.

As a general rule the FAR prefer direct determination over indirect methods, as clearly expressed in the hierarchy of approaches discussed in section 6.6 of this document.

FAR Annex VII section 3.4 provides a broad range of indirect methodologies, in particular for the attribution of measurable heat to sub-installations, as heat meters are often not sufficiently available, and heat consuming processes are very diverse (such as driving (endothermic) chemical reactions, heating, drying, distilling of materials, space heating, disinfection, etc.):

“Where no direct metering or analysis approach is available for a required data set, in particular for cases where net measurable heat is going into different production processes, the operator shall propose the use of an indirect determination method, such as:

(a) calculation based on a known chemical or physical process, using appropriate accepted literature values for the chemical and physical properties of substances involved, appropriate stoichiometric factors and thermodynamic properties such as reaction enthalpies, as appropriate;

(b) calculation based on the installation's design data such as the energy efficiencies of technical units or calculated energy consumption per unit of product;

(c) correlations based on empirical tests for determining estimation values for the required data set from non-calibrated equipment or data documented in production protocols. For this purpose, the operator shall ensure that the correlation satisfies the requirements of good engineering practice and that it is applied only to determine values which fall into the range for which it was established. The operator shall evaluate the validity of such correlations at least once a year."

Once an appropriate method for attribution of a relevant parameter to sub-installations has been developed, further parameters (if correlated) can be attributed accordingly⁵⁸. If for example an installation has to split the total measurable heat consumed according to CL and non-CL of the production processes, the same ratio of heat consumption can then be applied to splitting the installation's fuel quantities, energy input and emissions according to sub-installation boundaries.

The metering of measurable heat might be a special case. The use of a single heat meter which has all necessary parameter measurements integrated would be considered direct determination. Similarly, the measurement of the heat medium's flow, temperature and state in a single pipe at the outlet of the boiler, in combination with a single location for the measurement of the flow/temperature at the return point to the boiler, could be considered a direct determination. On the other hand, the separate metering of temperatures and flow (and saturation state) at different locations would potentially be considered indirect measurement, in particular if not all of the necessary quantities are measured at all points needed. In case of doubt the operator should seek the agreement of the competent authority when selecting data sources.

6.5 Examples of indirect determination methods and correlations

Example 1 – heat BM sub-installations (chemicals)

In this example measurable heat is produced in one CHP unit. It is then consumed in two production processes, one producing a CL exposed product, and the other a non-CL product. Therefore, the attribution of the heat (and the associated fuel consumption and emissions) are to be assigned to the respective heat benchmark sub-installations. For the example it is assumed that few direct measurements are available.

⁵⁸ FAR Annex VII section 10.1.1 last dash: *"Where emissions from source streams or emission sources cannot be attributed in accordance with other approaches, they shall be attributed using correlated parameters, which have already been attributed to sub-installations in accordance with section 3.2. For that purpose, the operator shall attribute source stream amounts and their respective emissions proportionally to the ratio in which those parameters are attributed to sub-installations. Appropriate parameters include the mass of products produced, mass or volume of fuel or material consumed, amount of non-measurable heat produced, operating hours, or known equipment efficiencies."*

Step 1: Determine measurable heat produced: Minimum known information would be the fuel input to the CHP unit as well as the design efficiencies for production of electricity and heat. The fuel input is already required under the MRR and therefore known. The operator can determine the amount of measurable heat produced using the design efficiency and the fuel input, using section 8 of Annex VII of the FAR (see section 6.10). Once this is known, the emissions related to heat production can be determined, too. The remaining emissions belong to electricity production and are therefore not attributed to any sub-installation.

Step 2: Determine the split between the CL and non-CL heat benchmark sub-installation: The operator may propose to make this split by assigning the total heat amount proportionate to the mass of the two products, each multiplied by a weighing factor. In this case the mass of the two products is directly measured, and the weighting factors are taken from the design documentation of the installation (assuming that this documentation contains an information such as “x TJ heat consumed per tonne of product”, or “y tonnes of saturated 110°C steam” – the minimum requirement here would be that the information is available for both products and using comparable units. In this case, TJ heat and tonnes of steam can be compared by using appropriate steam tables). The MMP must contain a description of and justification for the way how the weighing factors are determined and applied.

In this example the following equation would apply:

$$H_{total} = H_{CL} + H_{nonCL} = h_{CL} \cdot M_{CL} + h_{nonCL} \cdot M_{nonCL}$$

Where H_{total} is the total amount of measurable heat consumed in the installation, H_{CL} and H_{nonCL} are the variables to be determined, and h is the specific heat consumption per tonne of product, and M the mass of the product in tonnes. Since there are only two products, only one of the two specific heat consumptions has to be known, if the total heat is known. If all three variables are known, a reconciliation factor may be necessary (see example 4 in section 6.3.1).

The fuel input and emissions of each sub-installation can be determined from the heat-related data determined in step 1, using the ratio H_{CL}/H_{nonCL} determined in step 2.

Example 2: Lime kiln with 2nd product

This builds on the installation described in section 4.5: Assuming there is not any gas metering at this kiln, determination of natural gas belonging to the lime sub-installation and to the fuel BM sub-installation requires the following information:

- Measurement of the time period where (saleable) lime is produced, and/or when magnesium oxide is produced, including a definition of when the split is to be made (it has to be assumed that there is a period in between during which neither saleable lime nor saleable magnesium oxide is produced, yet the gas consumption must be attributed somewhere). For the latter, a simple assumption would be that the decisive point in time is always when the feed of the new raw material is started⁵⁹.

⁵⁹ If sufficiently justified, also more complicated procedures could be used. If e.g. the output of the intermediate production period is fed to the cement clinker production at that example site, the related gas consumption as well as related process emissions could be considered part of the clinker sub-installation.

- As burning of magnesium oxide and of lime happens at different process temperatures, it is unlikely that the same amount of gas is consumed per hour in both cases. For determining the hourly gas consumption, the operator has the following possibilities:
 - Carry out tests at a time when no other gas consumers are operating at the installation, e.g. during maintenance of other units at the installation;
 - Use literature values for the specific energy demand of burning lime and magnesium oxide (and using some adjustment factors for heat losses, for which reasonable assumptions have to be made);
 - Etc.

Examples for correlations

Other examples where correlations may be useful: According to the MRR Annex IV section 9, the amount of clinker produced can be “back-calculated” using the amount of cement produced and the clinker/cement ratio of different cement grades produced. The opposite calculation can be used to determine the cement amounts needed in the example presented in section 4.5.

The MRR also explicitly allows the use of “empirical correlations”, e.g. the determination of emission factors based on density measurements of specific oils or gases, including those common to the refinery or steel industry (i.e. waste gases in the FAR sense), or emission factors based on the net calorific value for specific coal types. Those correlations have to be determined applying the common rules laid down for laboratory analyses.

6.6 Selecting the most accurate data source

Article 7 of the FAR require the operator to use “*data sources representing highest achievable accuracy pursuant to section 4 of Annex VII*”. The process of selecting these data sources is explained in this section.

In many cases the operator has several options to determine a certain data set. There may be for example the choice between adding the values of several sub-meters to give the total, or to use the total meter as primary data source and use the sub-meters only for the split into sub-installations. There may also be the choice between meters under the operator’s own control and other meters (e.g. under the fuel supplier’s control). On the other hand, there may also be a lack of meters or of analyses, and the operator may have to come up with one or more indirect methods (including estimations or correlations, where necessary), and choose between these.

For each data set the operator has to choose determination methods both for historical data and for monitoring data. Often this is not further mentioned in the FAR and this document, as it can be assumed that there are available historical data in records of measurements using the same instruments as for the future monitoring. However, due to the improvement principle (e.g. installation of new additional meters), data sources for historical and new data may (have to) differ. The approach to selecting data sources is mostly the same for both kinds

of data, with the only exception that for future monitoring the operator may have to install measuring instruments or perform analyses which are not available for historical data.

Selection process⁶⁰: As has been mentioned in section 5.2 on the development of the MMP, operators should first list all available data sources for each parameter (data set) required. Where there is the need to use indirect methods, it is usually useful to consider several different methods. Even where direct measurement is possible, it is important to think of further data sources for the purpose of carrying out corroborating checks. Wherever the operator has more than one option for monitoring, Article 7 and Annex VII section 4.3 of the FAR require the operator to select the “best” data source as primary data source (i.e. the one which delivers the data which ultimately end up in the baseline data report), where possible a “second best” source as corroborating data source. The latter’s importance is outlined in sections 5.5 and 5.6 of this document. The description of the hierarchy of sources below applies to both, primary and corroborating, data sources.

“Best” data sources are firstly those that rank highest in the hierarchy of approaches (section 6.6.1 below). However, operators should also take into account that the chosen sources shall “ensure a clear data flow with lowest inherent risk and control risk”⁶¹. Where relevant for the choice of the data source, the operator should give a relevant justification in the MMP for deviating from the hierarchy of data sources.

Note: For all parameters to be determined, the annual data are required, meeting the boundaries between calendar years (midnight of 31 December) as closely as reasonably possible. Section 5 of Annex VII of the FAR contains the relevant provisions for that purpose. Since they are identical to similar MRR provisions, no further guidance is given here. Section 6.1.2 of MRR GD 1 gives the required information for emissions monitoring, which can be applied mutatis mutandis to all FAR data sets.

6.6.1 Hierarchy of data sources

The FAR in Annex VII sections 4.4 to 4.6 provide a hierarchy for different generic types of data sets. It is a “hierarchy”, because the FAR clearly state that the first one or two points listed are considered “highest accuracy”, the others being second-best to worst in descending order. Thus an operator can determine for each data source to which category it fits, and the higher the category is located in the list, the better would be its use. In an ideal world only highest scoring data sources (i.e. only data sources of the first two categories) would be used. However, for limiting operators’ costs, Article 7 allows the following deviations:

- A data source of lower assumed accuracy may be used if the operator can demonstrate that data sources of higher accuracy would be technically not feasible or would incur unreasonable costs (see section 6.6.2), or
- If based on a (simplified) uncertainty assessment the chosen data source scores better than the alternative (see section 6.6.3).

⁶⁰ This process applies essentially to both, historical and monitoring data. However, “available” data source includes also the option to purchase new measuring instruments, while this option is obviously excluded.

⁶¹ Annex VII section 4.3.

The hierarchy is explained below in different words than in the FAR for making the underlying assumptions clearer. In case of doubt the text of the FAR is relevant.

1. Quantity of materials and fuels

Section 4.4 of Annex VII is applicable to all types of material inputs and outputs at installation and sub-installation levels. In MRR terminology the section applies to “activity data of source streams”. For FAR purposes, it furthermore covers activity data of internal source streams and waste gases, as well as production levels of sub-installations.

- The preferred approach is to follow the MRR’s logic for source streams. Where data is needed at installation level, therefore data in conformance with the approved MP under the MRR is considered best quality and should always be used. This avoids inconsistencies in case another source would be chosen, and reduces administrative burden by avoiding the need for another justification of the choice of the data sources.

However, for material flows not necessary under the MRR (i.e. only flows between sub-installations, i.e. “internal source streams”), no data sources are included in the MP, and this “best” source is not available.

- For all data sets not yet included in the MP under the MRR, the choice of data sources should be less burdensome than under the MRR. Therefore, no tiers are defined, and the choice is based on more qualitative criteria. For direct determination of data sets, the following applies:
 - Measuring instruments under national legal metrological control, or complying with the MID⁶² or NAWI⁶³ Directive are preferred over other instruments, independent of their uncertainty characteristics. In this case the FAR don’t express a preference whether the instrument is under the operator’s own control or not (this is because legal metrological control is often applied on case of commercial transactions, and are usually trusted by both trade partners)⁶⁴.
 - Next best are other instruments under the operator’s control, independent of their uncertainty characteristics. The reason for the preference over instruments not under the operator’s control may be the fact that the operator has all necessary information and means to perform relevant calibration and maintenance of the instruments.
 - If there are no instruments under the operator’s control, the next best solution is measuring instruments not under his control (e.g. the fuel supplier’s instruments).
- Next in the hierarchy are measuring instruments for indirect determination of data sets in combination with appropriate correlations (see section 6.4). Although not explicitly mentioned in the FAR, the operator may again have a choice between instruments for

⁶² Measuring Instruments Directive (2014/32/EU)

⁶³ Non-Automatic Weighing Instruments (Directive 2014/31/EU)

⁶⁴ Evidence for compliance with MID or NAWI Directive is usually the appropriate CE marking on the instruments. Compliance with NLMC can be demonstrated by different forms of verification markings. Examples are given in the training material on uncertainty assessment, see https://ec.europa.eu/clima/sites/clima/files/ets/monitoring/docs/uncertainty_assessment_training_material_en.pdf

indirect determination of data, and there again the hierarchy regarding legal metrological control and operator's own control would apply.

- If all else fails, the FAR allow "other methods", in particular for historical data. This would be comparable to the "No-tier approaches" of the MRR⁶⁵.

2. Quantification of energy flows

Section 4.5 of FAR Annex VII applies to "energy flows", i.e. (net) flows of measurable heat and electricity. It does not apply to non-measurable heat, as in this case the amount of the related fuels is to be monitored (see previous sub-heading and section 4.4 of FAR Annex VII).

The hierarchy is quite similar as under point 1 above (material quantities), but there is no reference to approved MPs (as such energy flows are not relevant under the MRR). The highest level provided in section 4.4 of FAR Annex VII refers therefore only to "readings of measuring instruments subject to NLMC or measuring instruments compliant with the requirements the MID or NAWI Directive for direct determination of a data set". It is to be acknowledged that at this time the MID does not cover heat meters for steam. Therefore – unless there are NLMC provisions available at MS level – this highest level cannot be reached in steam networks in practice. In order to pragmatically avoid undue necessary burden (demonstrating unreasonable cost etc.) in case of steam networks, CAs are advised to consider the achievement of this highest level generally as "technically not feasible" without requesting further evidence from operators.

Furthermore the hierarchy clarifies that method 3 for measurable heat determination (based on a proxy, see section 7.2 of FAR Annex VII, explained in section 6.9 of this document) is considered inferior compared to the other methods provided in that section 7.2 of Annex VII.

Furthermore, the last paragraph of section 4.5 of FAR Annex VII contains provisions for more complex determination of measurable heat. It states that in cases where not all parameters are available which are needed to determine net heat flows, section 7 of Annex VII is to be applied (see section 6.9 of this document). For justifying a certain approach of monitoring using an uncertainty assessment, the uncertainty impact on the heat flow data is to be assessed, not on a single parameter in the heat flow determination (e.g. not only a temperature or a flow).

3. Properties of materials

Section 4.6 of FAR Annex VII gives the hierarchy of approaches for "properties of materials", meaning the composition and other chemical or physical properties of the materials insofar as they have an impact on emissions or allocation data. In MRR terminology this includes the determination of the calculation factors⁶⁶. Materials include all fuels, inputs and outputs of the installation and its sub-installations (including waste gases), as well as the products to which benchmarks apply.

⁶⁵ Note however that the no-tier approaches under the MRR require a full uncertainty assessment, which is not required under the FAR.

⁶⁶ Emission factor, NCV, carbon content, biomass fraction, etc.

The following hierarchy applies:

- Best data is determined in accordance with the approved MP under the MRR;
- Laboratory analyses in accordance with FAR Annex VII section 6.1 are considered equally “best”, if the parameter under consideration is not included in the MP. Section 6.1 basically requires that Articles 32 to 35 of the MRR are applied. A suitable frequency of analyses (i.e. the size of the batch from which representative samples are to be taken) has to be agreed with the CA based on the heterogeneity of the material. Please see MRR guidance document 5 for more information on sampling and analyses.
- Next best are simplified laboratory analyses in accordance with section 6.2 of FAR Annex VII. That section allows analyses simplified in various ways, e.g. by allowing methods based on industry best practice instead of European (CEN) or other standards, of lower frequency (at least once per year), and using laboratories which don’t meet the MRR’s requirements.
- Constant values “type II” (Values used by the MS in its national GHG inventory, literature values agreed with the CA, values guaranteed by the supplier);
- Constant values “type I” (Values found in Annex VI of the MRR, other standard factors found in the IPCC guidelines, values based on analyses carried out in the past, other values based on scientific evidence).

The terms “type I” and “type II” are inspired by MRR GD 1 (section 6.2.1) and are used here just for ease of reference. They are not found in the FAR.

4. Additional guidance for historical data

As mentioned in the introduction of this section, the FAR do not differentiate historical and (new) monitored data regarding the hierarchy of data sources. However, operators may sometimes have difficulties in deciding which kinds of documents might be best to use for historical data. Therefore the following guidance may be useful for document-based evidence where no information on the measuring instruments is available that would allow a classification of the data source according to the hierarchies given in sections 4.4 to 4.6 of Annex VII of the FAR:

- Best are documents or electronic data such as invoices, issued in context of commercial transactions between two independent trade partners (because it is assumed that the trade partners exert mutual quality control on their data);
- Equally useful are documents or electronic data such as sales data and parts of production protocols which have undergone an audit (such as financial audits for taxation or corporate reporting);
- Next best are documents like internal cost attributions or pro forma invoices used to allocate energy or raw material costs to different products or business units within an installation, where trade partners are not independent entities, but still have an interest in the data and therefore perform independent reviews (4-eyes principle);

- Least accurate data are found in documents or electronic data like production protocols which have not undergone audits or dedicated control activities⁶⁷.

6.6.2 Technical feasibility and unreasonable costs

As for the MRR and AVR, cost effectiveness is an important principle enshrined in the FAR. It is most visible in the rules for selecting most accurate data sources, where the two concepts “technical feasibility” and “unreasonable costs” are used for allowing the operator to justify the choice of data sources lower in the hierarchy of approaches.

Technical feasibility

Section 4.1 of FAR Annex VII outlines the conditions on which the operator may claim that a certain monitoring methodology is “technically not feasible”: It requires the operator to provide evidence and the CA to assess if the claim is justified. Furthermore, that section clarifies that “technically feasible” means that the operator has *“technical resources capable of meeting the needs of a proposed system or requirement that can be implemented in the required time for the purposes of this Regulation. Those technical resources shall include availability of required techniques and technology.”* This shows the concept is not about costs, but whether a measure is possible at all (within reasonable time). Typical reasons for technical infeasibility include:

- There is not enough space available for the installation of a certain measuring instrument;
- An instrument of lower uncertainty (or one falling under legal metrological control) is currently not available on the market;
- Installing a required instrument would require a (prolonged) shut-down of the installation.

The last bullet point can be also (and even better) argued to incur unreasonable costs.

For historical data only, the fact that data from a certain data source has not been recorded can be interpreted as “the use of that source is technically not feasible”. However, for monitoring data such situation has to be treated as a data gap, i.e. the operator has to put in place measures to avoid it.

Unreasonable costs

An operator can seek to avoid the selection of a data source higher in the hierarchy outlined in section 6.6.1, in particular installing more expensive metering equipment or performing more frequent analyses, if such measures would incur unreasonable costs. As for technical infeasibility, the operator has to provide appropriate evidence together with the MMP for the CA⁶⁸ to decide if the derogation is justified. As with the MRR, the FAR (Annex VII section 4.2) contain clear rules for determining if costs are unreasonable. The basic rule is to compare the costs caused by the “better” data source to its “benefit” compared to another data source, which is usually a source already available (and/or in use) at the installation, or a data source which the operator proposes to use instead of the data source of highest accuracy according

⁶⁷ Further criteria here may be if the documents are appearing complete, transparent, noted down at the time when data were created and not corrected later, etc.

⁶⁸ In cases where the CA has not yet approved the MMP, it is the verifier who has to make this decision.

to the hierarchy of approaches. Where the costs exceed this benefit, costs are considered unreasonable. However, there is a *de-minimis* threshold defined. If all costs as defined below cumulatively do not exceed the threshold, they are considered reasonable. This threshold is 2 000 € per year for normal installations, and 500 € for “installations with low emissions” as defined by MRR Article 47.

Costs: Like under the MRR, “costs” refers only to *additional* costs compared to the alternative data source. All relevant costs should be taken into account, i.e. investment (annual depreciation based on a reasonable life time of the equipment) capital costs based on a realistic interest rate, operation costs, including maintenance, spare parts, personnel costs etc. An example is given in section 4.6 of MRR GD 1, and further information can be found in the user instructions of the Excel tool⁶⁹ for calculating unreasonable costs under the MRR provided by the Commission.

Benefit: The benefit is expressed based on an assumption that the improved accuracy of monitoring can be expressed as the financial value of allowances. Like the MRR the allowance price is fixed⁷⁰ at 20 € for this purpose. This price is multiplied with an “improvement factor” (expressed as allowances or as tonnes CO₂ per year). However, the MRR’s approach based on uncertainty thresholds for the different tiers is not applicable under the FAR, because no tiers are defined. The improvement factor can refer to several different types of data sets. The FAR’s provisions are therefore more diverse than the MRR’s:

- The default rule is that the improvement factor is “1% of the most recently determined sub-installation’s annual allocation free of charge”. This is relatively simple to determine based on the operator’s NIMs baseline data report submission, or – if applicable – latest submission on activity level changes.
- As the value according to the previous point may be relatively high, operators can choose other, more specific improvement factors based on “1% of the affected CO₂ equivalent”:
 - In case of source streams (including waste gases or other internal source streams), the improvement factor is 1% of its CO₂ “content” (i.e. carbon content multiplied by 3.664 [t CO₂ / t C]).
 - For emissions determined by CEMS the improvement factor is 1% of the emissions of the respective emission source.
 - For measurable heat, the improvement factor is 1% of heat multiplied by the heat benchmark⁷¹;

⁶⁹ https://ec.europa.eu/clima/sites/clima/files/ets/monitoring/docs/unreasonable_costs_tool_en.xlsx

⁷⁰ Such fixed amount reduces administrative burden for checking market prices and provides certainty over time on whether a certain monitoring approach incurs unreasonable costs: The situation whether or not the measure incurs unreasonable costs changes over time only due to changing costs of the measure, but not due to the benefit.

⁷¹ In this case it seems justified for practical reasons to use the latest known benchmark value, i.e. the value used for the previous allocation period, unless the new value has already been published by the Commission. This would be in line with the approach mentioned for product benchmarks (see footnote 73).

- For electricity quantities, 1% of the relevant annual amount of electricity multiplied by 0.376 t CO₂/MWh⁷²;
- For activity levels of product benchmark sub-installations (i.e. for the amounts of production): 1% of the activity level multiplied by the product benchmark⁷³.

The FAR do not specify the time period as basis for determining the improvement factor. However, for making the data representative operators are advised to use the MRR's approach (i.e. average data of the last three years, or – where such data are not available or not representative – a conservative estimate thereof).

6.6.3 Simplified uncertainty assessment

The concept of determining the uncertainty of a measuring instrument has become a well-established feature of EU ETS monitoring and reporting, because the compliance with the different tiers defined via maximum allowed uncertainties. Nevertheless, the topic of uncertainty assessment is often perceived as one of the most complicated areas of monitoring under the MRR. The Commission has therefore published several documents regarding uncertainty assessment on the EU ETS MRVA website⁷⁴, of which in particular MRR GD 4 gives a good introduction to the topic.

However, for the FAR uncertainty assessments are of less importance as the monitoring principles do not require meeting a certain tier but set out a hierarchy of different monitoring approaches. An uncertainty assessment is therefore only required if an operator wants to convince the competent authority that an approach lower in the hierarchy of approaches (see section 6.6.1) is “better” than an approach higher in the hierarchy, where the higher approach would be technically feasible without incurring unreasonable costs. “Better” in this context would mean indeed that the uncertainty would be lower. Examples for such situations might be e.g.:

- The operator does have own measuring instruments available, and can demonstrate that the one belonging to a trade partner has lower uncertainty;
- The operator would like to use an indirect metering approach, because existing measuring instruments for direct determination of the data set are known to be unreliable (e.g. requiring unusually frequent adjustment);
- The operator wants to use an instrument that allows automatic data collection, while another instrument is available that is under national legal metrological control.

In such situations the operator has to carry out a (simplified) uncertainty assessment. The guidance material⁷⁴ already mentioned should be consulted. However, the FAR do not specify what “simplified” means. Therefore, the following suggestions may be useful:

⁷² This is the “factor specified in Article 22(3)” mentioned in FAR Annex VII section 4.2 point (e).

⁷³ The FAR specify here that in case the BM has not yet been updated, the values of the third phase (which are contained in Annex I of the FAR) should be used.

⁷⁴ For the link to the website see footnote 1. The following material is available on uncertainty assessment: MRR GD 4 “Guidance on Uncertainty Assessment”, GD 4a “MRR Guidance on Uncertainty Assessment – Example”; and “Training on Uncertainty Assessment – M&R Training Event of 31 May 2016 “.

- A “full” uncertainty assessment has to take into account:
 - How the instrument’s readings are used for calculating the parameter under consideration (e.g. how individual measurements contribute to the uncertainty over the whole reporting year). In case of indirect determinations, the error propagation law has to be applied accordingly for individual measurements.
 - The instrument’s specified uncertainty (based on maximum permissible error (MPE) given in legislation, or the producer’s specifications, or taken from a calibration certificate, etc.)
 - Factors that influence the uncertainty in use (e.g. whether the use environment is in accordance with the specifications, whether ageing, corrosion, or other systematic sources of error play a role, etc.)
 - Further factors, such as “safety margins” for unknown sources of error.

When carrying out a *simplified* uncertainty assessment, the operator should use expert judgement (e.g. based on experience gathered from uncertainty assessments the operator has already performed for the MP under the MMP) to decide which of the above factors mentioned in the last two bullet points can be disregarded, if not easily accessible. For example, where there is information available about the “maximum permissible error in service” (MPES), the latter may be useful as the uncertainty of the single measurement, as it already contains a safety margin compared to the MPE. Where more doubt exists (e.g. environment of the instrument is much more disturbed than allowed by the instrument’s specification), the operator should apply reasonable efforts to assess at least some more important influencing factors.

6.7 Handling of units used by several sub-installations

As already mentioned for the example presented in section 4.5, physical units are not *attributed* to individual sub-installations in the same way as inputs, outputs and emissions. The assignment of physical units is just a tool for better understanding of the MMP, and should therefore be described in the MMP (as part of the description of the installation and its processes) and in the relevant diagrams (e.g. for identifying where data has to be determined for making splits according to sub-installations).

Where physical units are used by several sub-installations, the attribution of data to sub-installations – or at least the way in which the baseline data report is to be completed – may sometimes be possible in different ways. Therefore, the NIMs baseline data report template contains a special option to handle relevant data (in particular heat flows, but also source streams / related emission factors) separately from data which can be immediately attributed to sub-installations. However, this should not invite consideration of such jointly used units as separate from the sub-installations, or even as sub-installations on their own.

The example MH-4 in Annex A (section 7.3.3) suggests for such a case that first the measurable heat from the jointly used boiler is attributed to the sub-installation, but the related fuel input is set to 0 in the reporting template for each sub-installation. This is only needed for consistency checking, and for ensuring that all operators report these situations in the same way. However, the fuel input and related emissions can be determined using the detailed heat

balance given for each sub-installation, where heat coming from a unit serving several sub-installations would be considered an “import”. Note that the above only relates to “*how the template is to be completed*”. It does not contradict the fact that fuels and their emissions have to be attributed to sub-installations.

In practical terms, in particular for the attribution of measurable heat from one boiler/CHP to several sub-installations, the precise split between the different heat benchmark sub-installations is determined using the heat balance (section E.II of the template), and the related fuel input emissions are thereafter determined proportionally to the heat split, applying the last point of section 10.1.1 of FAR Annex VII (mentioned in section 6.4 and footnote 58).

6.8 Monitoring of production levels

The FAR do not contain many rules dedicated to the monitoring of production levels. However, it is clear that production levels are at the very core of FAR monitoring. The following can be said to summarise the requirements here:

- As already explained in section 4.2 and in the example presented in section 4.5, the following items have to be monitored for each sub-installation:
 - The identity/quality of the product (“what is produced?”, including in particular which PRODCOM code or other parameter is applicable for ensuring the product complies with the product definition of the specific sub-installation⁷⁵), and
 - The quantity of the product. In case of product benchmarks, this is based on the reference state as defined by Annex I of the FAR. This may require the monitoring of further parameters in accordance with Annexes II and III of the FAR. In case of fall-back sub-installations, products have to be reported at least as disaggregated as the corresponding PRODCOM or NACE code used in the Carbon Leakage List.
- For selecting monitoring approaches, the hierarchy for “materials and fuels” applies (see section 6.6.1); In many cases invoices to clients or other data used for financial purposes (and so audited; this may include data on product stocks) will be useful data sources.

For product benchmarks, the following detailed step-by-step approach should be considered. The operator should:

- Identify all products relevant to the sub-installation in accordance with Annex I of the FAR;
- Determine the annual uncorrected amounts of products in tonnes per year^{76,77};

⁷⁵ FAR Annex VI requires that for each sub-installation (i.e. including the fall-back sub-installations), the operator has a *procedure* for keeping track of the products produced and their PRODCOM codes. Detailed requirements for that procedure are outlined in Annex VII section 9.

⁷⁶ Or another relevant unit per year (e.g. m³ etc.).

⁷⁷ Section 5 of Annex VII of the FAR contains the relevant provisions for that purpose. Since they are identical to similar MRR provisions, no further guidance is given here. Section 6.1.2 of MRR GD 1 can be consulted for more information.

- Where Annex I of the FAR refers to a specific moisture content, purity, concentration or other specific state,
 - determine the actual state (see section 6.6.1 sub-heading “Properties of materials”); and
 - determine the corrected amount of product to be reported as annual activity level;
- Where data for several products falling within the same sub-installation are determined separately in line with the previous points, add up the corrected annual production data for reporting as annual activity level;
- Where in accordance with Annex II or III of the FAR further parameters are required to determine the annual activity level of the sub-installation, determine the annual values or annual average values, as required, for these additional parameters and calculate the annual parameters required for the baseline data report.
- For avoiding any double counting, the operator shall ensure that products returned into the production process are deducted from annual activity levels, as appropriate in line with product definitions in accordance with Annex I of the FAR.

6.9 Monitoring of measurable heat

As already briefly explained in section 4.7, all measurable heat under the FAR is to be understood as “net heat”, i.e. the difference between the enthalpy entering a heat consuming process and the enthalpy returning from that process⁷⁸. Therefore, a precise monitoring of such heat quantities requires the determination of several parameters:

- Flow rate of the heat medium (most appropriate is the mass flow) to the process
- State of the medium entering the heat consuming process; where “state” includes all parameters relevant for determining the specific enthalpy of the medium:
 - Type of the medium (hot water, steam, molten salt or metal, solutions or dispersions of diverse materials, etc.);
 - Temperature;
 - Pressure (in case of steam or other gases);
 - Information on saturation/super-heating in case of steam;
 - Concentration for solutions;
 - Etc.
- State of the medium leaving the heat consuming process;
- If the flow rate of the returned medium is different from the forward flow or unknown, suitable assumptions for its enthalpy are required.

⁷⁸ As also mentioned in section 4.7, the heat consumer can be a process within the installation, in the same or another sub-installation, or outside the installation. Also the production of “cooling” (by using an absorption heat pump) is considered a heat consuming process.

Such determination is a difficult task, in particular because industrial installations sometimes have complex heat networks with several heat sources and a multitude of consumers.

Therefore, FAR Annex VII section 7.2 provides the following methodologies for determining net amounts of measurable heat⁷⁹:

- Method 1: Using measurements: In this method, all necessary parameters⁸⁰ are known as listed above. In case the condensate is not returned or its flow unknown, a reference temperature of 90°C is to be used.
- Method 2: This method is meant for historical data only, as it refers to “*documents based on metering or estimation methods*”. Guidance provided in section 6.6.1, sub-heading 4 (“Additional guidance for historical data”) should be taken into account.
- Method 3: This builds on the energy input of all fuels, and determines the net heat flow based on the known efficiency of the boiler. It refers to “measured efficiency” because the operator is advised to measure it “*over a reasonably long period*”. Alternatively, the efficiency can be taken from the boiler manufacturer’s documentation (which is obviously the less preferred approach considering the generic hierarchy of approaches). Method 3 as a whole is explicitly considered to be of a lower accuracy than method 1 (see section 6.6.1, sub-heading 2 “Energy flows”).
- Method 4 is meant for situation where “all else fails”: It is the same as method 3, but for unknown boiler efficiencies. The rather conservative assumption is that the efficiency would be 70%.

6.10 Rules on CHP

In addition to the rules on heat monitoring explained in section 6.9, there is one more topic that requires attention where CHP (Combined Heat and Power generation, also referred to as cogeneration) is used. In this case the emissions have to be separated into one part for heat and one part for electricity. As it is one inseparable process, assumptions have to be made. In order to ensure consistency with phase 3 of the EU ETS and with the Commission’s guidance provided for the option for transitional free allocation for the modernisation of the energy sector (applicable only in certain MS) based on Article 10c of the EU ETS Directive⁸¹, the FAR require a specific formula to be used for performing the split (FAR Annex VII section 8). The

⁷⁹ Since that FAR section is written using a technical rather than legal language, it should be clear without too much additional guidance. It is therefore not replicated in full here. Furthermore it is assumed that operators are familiar with the methods listed there, as they were given in a guidance document for phase 3 before.

⁸⁰ Relevant parameters are in particular temperature, pressure, state (saturation or degree of superheating) of the transmitted as well as the returned heat medium, and the (volumetric) flow rate of the heat transfer medium. Based on the measured values, the operator determines the enthalpy and the specific volume of the heat transfer medium using suitable steam tables or engineering software.

⁸¹ Commission Decision of 29.3.2011 on guidance on the methodology to transitionally allocate free emission allowances to installations in respect of electricity production pursuant to Article 10c(3) of Directive 2003/87/EC, C(2011) 1983 final.

formula is also in line with the approach for determining whether a CHP can be considered “high efficiency cogeneration” in line with the energy efficiency Directive⁸², and therefore builds on the related reference efficiencies for separate generation of heat and electricity⁸³.

As that section of the FAR is quite self-explanatory it is not replicated in full here. However, for MRV purposes the operator should keep in mind that the reference efficiencies to be used for the calculations should be explicitly included in the MMP.

6.11 Rules on cross-boundary heat flows

The transfer of measurable heat across the installation’s boundaries can have significant impacts on the installation’s free allocation. Guidance document No. 6 of this series (“Cross-Boundary Heat Flows”) gives extensive information on this topic.

From MRV point of view, those rules mean that the operator has to ensure that the MMP contains all necessary provisions for the following:

- Where an installation imports measurable heat, the operator shall determine *separately* the quantity of heat imported from installations covered by the EU ETS, and heat imported from non-EU ETS entities such as district heating networks.
- Where an installation consumes measurable heat exported from a nitric acid product benchmark sub-installation⁸⁴, the operator shall determine that amount of heat consumed separately from other measurable heat.
- Where an installation exports measurable heat, the operator shall determine *separately* the quantity of heat exported to installations covered by the EU ETS, and heat exported to non-EU ETS entities (in the latter case a distinction for CL and non-CL heat use is required). Furthermore, the operator shall determine separately quantities of heat qualifying as district heating. Note the rules applicable for the distinction of those heat exports as discussed in section 6.12, sub-heading 2.

6.12 Detailed heat balance

Note: This section is relevant only for

- installations that have flows of measurable heat which are not attributed to product benchmark sub-installations;
- installations that have imports or exports of measurable heat;

⁸² Directive 2012/27/EU

⁸³ Those reference values are found in the Commission Delegated Regulation (EU) 2015/2402, which is also cited in the FAR.

⁸⁴ This sub-installation can be part of the same installation.

- installations where measurable heat is transferred between sub-installations; or
- installations where heat from nitric acid production is used.

Because under the FAR some types of imports and exports of measurable heat are not eligible for allocation, the exact determination of the eligible heat can be demanding, as the baseline report template shows. The operator has to make sure that each parameter in the following step-by-step approach is monitored (and included in the MMP appropriately⁸⁵), if it is relevant at the installation. The steps for determining the boundaries and the annual activity level of the heat BM sub-installations are:

1. Heat balance

- Determine the annual amounts of all flows of measurable heat as required for the calculation below;
- Determine Q_{prod} as the total annual amount of measurable heat produced within the installation, with the exception of measurable heat produced in a nitric acid product benchmark sub-installation;
- Determine Q_{ETS_import} as the sum of annual amounts of measurable heat imported from installations included in the EU ETS;
- Determine Q_{nonETS_import} as the sum of annual amounts of measurable heat imported from entities not included in the EU ETS. Where measurable heat produced in a nitric acid product benchmark sub-installation is either produced in the installation or imported from an installation included in the EU ETS, the respective amount of heat is included in the amount Q_{nonETS_import} ;
- Calculate the total available measurable heat $Q_{total} = Q_{prod} + Q_{ETS_import} + Q_{nonETS_import}$
- Calculate the total available annual amount of “ETS heat” $Q_{ETS} = Q_{prod} + Q_{ETS_import}$ and the total available annual amount of “non ETS heat” $Q_{non-ETS} = Q_{nonETS_import}$
- Calculate the ratio of “ETS heat” to “total heat” $R_{ETS} = Q_{ETS} / Q_{total}$
- If electricity is produced in the installation from measurable heat, subtract the associated amount of measurable heat $Q_{El.prod}$ from Q_{total} to give $Q_{total,1} = Q_{total} - Q_{El.prod}$.
- If the heat amount $Q_{El.prod}$ can be distinguished as either “ETS heat” or “non-ETS heat” based on the heat transfer medium used or its parameters (temperature, pressure, etc.), it should be deducted from the respective amount of heat, as appropriate:
 $Q_{ETS,1} = Q_{ETS} - Q_{El.prod}$ or $Q_{non-ETS,1} = Q_{non-ETS} - Q_{El.prod}$
 If such distinction is not possible, the “ETS heat” and “non-ETS heat” are adjusted using the ETS heat ratio as follows:
 $Q_{ETS,1} = Q_{ETS} - R_{ETS} \cdot Q_{El.prod}$ and $Q_{non-ETS,1} = Q_{non-ETS} - (1 - R_{ETS}) \cdot Q_{El.prod}$
- Determine the annual amounts of measurable heat consumed by product benchmark sub-installations. Because the calculation of free allocation requires the identification of any “non-ETS heat” consumed in product benchmark sub-installations, the respective calculation is to be performed as follows:
 $Q_{ETS,2} = Q_{ETS,1} - \sum Q_{ETS,prodBM,j}$ and $Q_{non-ETS,2} = Q_{non-ETS,1} - \sum Q_{non-ETS,prodBM,j}$
 where $Q_{ETS,prodBM,j}$ are the amounts of “ETS heat” consumed by product benchmark sub-

⁸⁵ For the necessary number of measurement points and their placement see section 6.3.

installation j , and $Q_{non-ETS,prodBM,j}$ are the amounts of “non-ETS heat” consumed by product benchmark sub-installation j .

- If measurable heat is exported to installations included in the EU ETS, the related annual amount of measurable heat is to be deducted from the “ETS heat” as follows:

$$Q_{ETS,3} = Q_{ETS,2} - \sum Q_{export.ETS,n}$$

where $Q_{export.ETS,n}$ are the annual amounts of measurable heat exported to installation n .

- A corrected “ETS ratio” is calculated as follows: $R_{ETS,corr} = Q_{ETS,3} / (Q_{ETS,3} + Q_{non-ETS,2})$
- The annual amount of measurable heat consumed within the installation eligible for the heat benchmark is determined as $Q_{cons.heatBM} = Q_{cons.total} - Q_{El.prod} - \sum Q_{ETS,prodBM,j} - Q_{loss}$ where $Q_{cons.total}$ is the total amount of measurable heat consumed within the installation and Q_{loss} is the value for estimated annual heat losses within the installation. Alternatively, the amount $Q_{cons.heatBM}$ may be determined based on direct measurements, and Q_{loss} is determined based on that equation for the purpose of plausibility checking.
- The sum of annual amounts of measurable heat exported to non-ETS entities m is determined as $Q_{export.nonETS} = \sum Q_{export.nonETS,m}$
- The total annual amount of measurable heat eligible for allocation under either the carbon leakage heat benchmark sub-installation, the non-carbon leakage heat benchmark sub-installation or the district heating sub-installation, Q_{heatBM} as input for the split is determined as follows: $Q_{heatBM} = R_{ETS,corr} \cdot (Q_{cons.heatBM} + Q_{export.nonETS})$

Where an amount of heat Q is calculated as negative at any point above, it is set to zero, in order to avoid negative allocation values. Thereafter the split into CL and non-CL heat benchmark or district heating sub-installation can be made as follows.

2. Split of measurable heat into the appropriate sub-installations

Where the operator does not use the “95% rule” as derogation (see section 4.4), the operator should split the eligible annual amount of measurable heat Q_{heatBM} in order to determine the annual activity levels of the carbon leakage heat benchmark sub-installation, the non-carbon leakage heat benchmark sub-installation and the district heating sub-installation taking into account the following process, as required by Article 10(4) of the FAR:

- The operator should identify the relevant fraction of measurable heat exported for the purpose of district heating, and attribute it to the district heating sub-installation only to the extent that the operator can provide evidence to the CA that the heat use complies with the definition of district heating given by the FAR (see section 4.7 for the definition). Such evidence may be e.g. invoices to the heat consumers, from which it can be concluded that the heat use is for space heating and warm water production, but not for industrial production purposes⁸⁶;

⁸⁶ GD 2 specifies the following pragmatic approach for providing suitable evidence:

- *In cases of low temperature heat (with a design temperature below 130 °C at the heat producer’s entry point to the district heating network) delivered to a district heating network, it can be assumed that the conditions of the definition of district heating are fulfilled.*
- *In case of a design temperature of 130 °C and more, the heat will only be considered as delivered to district heating in case that the heat producer provides appropriate evidence, e.g. via annual sales figures*

- For other heat exports to non-ETS entities the operator should assume that they belong to the non-CL heat benchmark sub-installation, except for amounts of measurable heat for which the operator provides evidence to the satisfaction of the competent authority that the consumer of the measurable heat belongs to a sector or subsector deemed to be exposed to a significant risk of carbon leakage (i.e. a sector found on the Carbon Leakage List (CLL)).
- For measurable heat consumed within the installation, the operator should determine whether the heat consuming processes serve sectors found on the CLL by using the PRODCOM codes determined by applying the related procedure described in the MMP⁷⁵.

6.13 Determining the boundaries of the fuel BM sub-installations

Step 1: Determine eligible fuel quantities

For determining the boundaries and annual activity levels of fuel benchmark sub-installations before carrying out the split according to the CL risk, the operator should determine the “eligible” amount of non-measurable heat expressed in TJ as follows:

- Starting point is the total energy input to the installation in form of fuels (including waste gases imported from other installations) determined based on net calorific values, as monitored based on the MP approved under the MRR, reduced by the energy contained in source streams leaving the installations, if a mass balance approach is applied;
- The total energy input as determined by the previous point is reduced (without double counting) by
 - the energy content of fuels used for the production of electricity;
 - the energy content of fuels used for the production of measurable heat;
 - the energy content of all fuels attributed to product benchmark sub-installations;
- where flaring *other than safety flaring* takes place outside a product benchmark sub-installation, the energy content determined under the previous point is further reduced by the energy content of gases flared and the associated supporting fuels used for the flare;

For corroboration purposes, the operator should ensure that the energy content of fuels identified is used only for the following purposes:

- for the production of products not covered by a product BM;
 - for the production of mechanical energy other than used for the production of electricity;
- or

(for the entire baseline period) clearly indicating the amount of heat sold to the purposes of heating or cooling of space or the production of domestic hot water.

In both cases the heat producer has to confirm that heat reported as district heating is not subject to free allocation to other ETS installations.

- for heating⁸⁷ or cooling (including space heating or cooling, heating of water, process heating, etc.).

Other fuel uses (e.g. for waste treatment without heat recovery) will not qualify for the fuel benchmark sub-installations.

Furthermore the operator shall ensure that – to avoid double counting –

- Fuels used as reducing agent or for chemical syntheses should not be considered as fuel input into a fuel benchmark sub-installation;
- Any fuel which will ultimately end up in a waste gas is not included.

Where measurable heat is recovered from the flue gas after the use of non-measurable heat, to avoid double counting, the operator shall subtract the relevant amount of net measurable heat (i.e. the heat gained from this recovery process) divided by a reference efficiency of 90% from the fuel input (Article 10(5)(k)).

The resulting energy input is considered the annual production of non-measurable heat eligible for allocation under the fuel benchmark sub-installations.

Step 2: Split of the fuel BM into CL and non-CL sub-installations

Where the operator does not use the “95% rule” as derogation (see section 4.4), the operator should split the eligible annual amount of non-measurable heat determined above according to the CL exposure of the processes in which the heat is consumed using the PRODCOM codes determined by applying the related procedure referenced in the MMP⁷⁵.

Step 3: Defining monitoring needs

After performing steps 1 and 2, the operator has to determine which fuels require additional monitoring as compared to the MP under the MMP. Note that the calculation factors will rarely need separate determination. That would be necessary if e.g. two different coal types were used in physical units assigned to different sub-installations, in the unlikely case that in the MP those two coal types were treated as one single source stream (consisting of a mixture of both coal types). Therefore, usually only the quantities of fuels have to be split per sub-installation, and each fuel needs separate monitoring at sub-installation level only if it is relevant for more than one sub-installation.

6.14 Determining the boundaries of the process emissions sub-installations

Step 1: System boundaries

For determining the system boundaries and the annual activity levels of process emissions sub-installations before carrying out the split in accordance with CL exposure, the operator should determine the eligible amount of emissions expressed in t CO_{2(e)} as follows:

⁸⁷ Pre-heating of fuels is considered part of the heat generation process, i.e. counting it here separately as “heating” would lead to double counting of that heat amount.

- Starting point is the total emissions of the installation as monitored based on the MP approved under the MRR, excluding emissions from the combustion of waste gases;
- Those emissions are reduced by all emissions attributed to product benchmark sub-installations, heat benchmark sub-installations and fuel benchmark sub-installations, including emissions caused by source streams used for flue gas cleaning from combustion activities within these sub-installations;
- The resulting emissions are further reduced by emissions resulting from the production of electricity, emissions related to the recovery of measurable heat (in line with FAR Article 10(5)(k), see section 4.4), emissions relating to production of measurable heat exported to EU ETS installations, and emissions resulting from flaring other than safety flaring which is not included in product benchmark sub-installations;
- The resulting emissions are taken into account for the next step, provided that the operator provides evidence to the satisfaction of the competent authority that the emissions comply with at least one of the following criteria:
 - The emissions consist of greenhouse gases other than CO₂; or
 - The emissions are caused by processes listed in Article 2(10) of the FAR, and not caused by flue gas cleaning processes;

- Where the installation produces waste gases^{88,89} which are not produced within a product benchmark sub-installation, an amount of emissions Em_{WG} is added⁹⁰ to the emissions determined under the previous points. Em_{WG} is calculated as follows:

$$Em_{WG} = V_{WG} \cdot NCV_{WG} \cdot (EF_{WG} - EF_{NG} \cdot Corr_{\eta})$$

Where V_{WG} is the volume of waste gas produced (which is not flared) expressed as Nm³ or t, NCV_{WG} is the net calorific value of the waste gas expressed as TJ/Nm³ or TJ/t, EF_{WG} is the emission factor of the waste gas expressed as t CO₂/TJ, EF_{NG} is the emission factor of natural gas (56.1 t CO₂/TJ), and $Corr_{\eta}$ is a factor that accounts for the difference in efficiencies between the use of waste gas and the use of the reference fuel natural gas. The default value of this factor is 0.667.

The resulting emissions are considered as the annual process emissions eligible for allocation under the process emissions sub-installations.

Step 2: Split of the process emissions into CL and non-CL sub-installations

Where the operator does not use the “95% rule” as derogation (see section 4.4), the operator should split the eligible annual process emissions determined above according to the CL

⁸⁸ Where the emission factor of the waste gas is lower than the emission factor of natural gas multiplied by the efficiency correction factor, this formula would result in a negative value to be added. Therefore, such waste gases should be treated like normal fuels.

⁸⁹ A specific rule applies where waste gases occurring outside the boundaries of product benchmarks are not used, mainly in cases of open furnaces (Article 10(5)(i) of the FAR). More information is presented in GD 8 (“Waste gases and process emissions sub-installation”).

⁹⁰ Note that the approach is presented in a different way than in section 7.3 on attributed emissions. Here the waste gases are added relatively late (in the first bullet point it is said “excluding the emissions from waste gases”). However, in section 7.3 the logic is to start from the emissions in accordance with the MP under the MRR, and a correction is made thereafter for *export* of waste gases. Both approaches are fully consistent.

exposure of the processes in which the heat is consumed using the PRODCOM codes determined by applying the related procedure referenced in the MMP⁷⁵.

Step 3: Defining monitoring needs

After performing steps 1 and 2, the operator has to determine which source streams require additional monitoring compared to the MP under the MMP. As for the fuel BM sub-installation it will be rarely necessary to determine the calculation factors separately per sub-installation. Usually only the quantities of source streams have to be split, and only if it is relevant for more than one sub-installation.

6.15 Rules for Waste gases

The importance of waste gases due to some specific allocation rules is explained in this document in sections 4.2, 7.3 and 6.14. Their treatment in terms of allocation rules is elaborated in GD 8 (“Waste gases and process emissions sub-installation”). From an MRV perspective, the following can be summarised:

- Waste gases are source streams like other fuels, and can therefore be monitored using the rules provided by the MRR (note in particular the rule on “inherent CO₂”, i.e. CO₂ already contained in the source stream is accounted by inclusion in its emission factor). However, where waste gases are relevant for more than one sub-installation, relevant splits need to be determined.
- Waste gases may occur as “internal source streams” which are not mentioned in the MP under the MRR. In this case no tier requirements of the MRR apply. However, the hierarchy of approaches (see section 6.6.1) regarding most accurate data sources applies.

6.16 Monitoring of electricity

There are two reasons why electricity quantities have to be monitored for the FAR:

- If there is electricity production at the installation, a balance of all electricity imported, produced, consumed and exported at installation level is required. This is for corroborating the completeness of fuel and heat data at the installation, since in this case less than 100% of inputs, outputs and emissions are attributed to sub-installations (see also the box on page 22).
- If a product benchmark sub-installation is relevant at the installation for which Annex I of the FAR specify that “exchangeability of electricity and fuels” is relevant, the respective exchangeable electricity quantity is to be monitored.

For MRV purposes this has the following consequences:

- Electricity meters have to be installed at the appropriate measurement points. In the absence of meters, the most appropriate estimation method is a combination of operating hours with the nominal efficiency (for electricity production) or nominal power of the consumers (for electricity consumption).

- Although not specified by the FAR, it appears logical that metering should apply to real power, not apparent power (complex power). I.e. only the active power component should be metered, and the reactive power should be disregarded⁹¹.
- With regard to sub-installations where exchangeability of electricity and fuels is relevant, the operator should ensure that:
 - the measurement points relate to specified parts of the sub-installation only, which are specified in Annex I of the FAR; and that
 - the operator establishes, documents, implements and maintains a procedure for regular checking whether the installation has been changed such that relevant electricity consuming parts have been added or removed from the installation, and for modifying the MMP accordingly, if relevant.

⁹¹ Should a very high phase displacement lead an operator to the conclusion that the monitoring of complex power would be more appropriate, a justification should be provided to the CA. If the CA agrees, this should be mentioned in the MMP, and the complete electricity balance should be consistently based on that type of measurements.

7 ANNEX A – CENTRAL CONCEPTS

7.1 What are benchmarks and sub-installations in the EU ETS?

Benchmarks are a means to compare the performance of peers with a reference value, which is called the benchmark⁹². Due to the restriction to “peers” it is important to ensure that only similar things are compared to each other. For example, it is not useful to compare the energy consumption of a paper production with the one of cement. For the purpose of the EU ETS the benchmarks are related to the GHG efficiency of production processes, expressed as greenhouse gas (GHG) emission intensity, more specifically as “direct emissions [t CO_{2(e)}] per tonne of product”, with the benchmark set as the average GHG efficiency of the 10% best installations in the sector in the EU (Article 10a(2) of the EU ETS Directive), as illustrated by Figure 5. Due to this definition there is no differentiation by installation size (i.e. all bars in the graph are the same width). Furthermore, products are the basis for the benchmarks, and no differentiation is foreseen for factors such as different technologies, raw materials, fuels or heat sources, installation age, geographical or climatic circumstances, etc.⁹³. Such approach requires a sound method to ensure equal treatment of installations across a wide range of circumstances, which is outlined in this section.

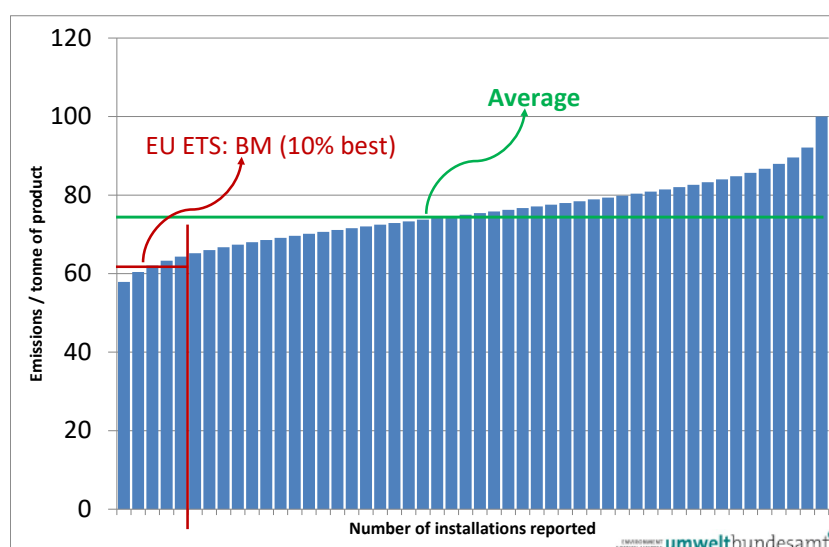

Figure 5: Illustration of how a benchmark is determined for the purpose of the EU ETS (based on Article 10a(2) of the EU ETS Directive). This diagram is also called a “benchmark curve”.

⁹² For EU ETS purposes it must be kept in mind that a benchmark is *not* an emission limit value that must be achieved by an installation. The benchmark is just one of several input values required for sharing the total available number of allowances among EU ETS participants.

⁹³ These principles were developed in a study by Ecofys and Fraunhofer ISI on benchmarking principles for the Commission, see

https://ec.europa.eu/clima/sites/clima/files/ets/allowances/docs/benchm_co2emiss_en.pdf

Where only one product (or a homogeneous group of products) is produced at an installation, it is relatively simple to determine such GHG efficiency, as shown in Figure 6. There just needs to be monitoring of the emissions (when using the MRR’s “standard methodology” this means monitoring of the amounts and quality of the input materials and fuels), as well as the quantity of (saleable) product. To be very sure about the correct approach, monitoring should include regular confirmation of whether the product quality still complies with the original product definition. This is required as the benchmark applies only as long as like with like is compared.

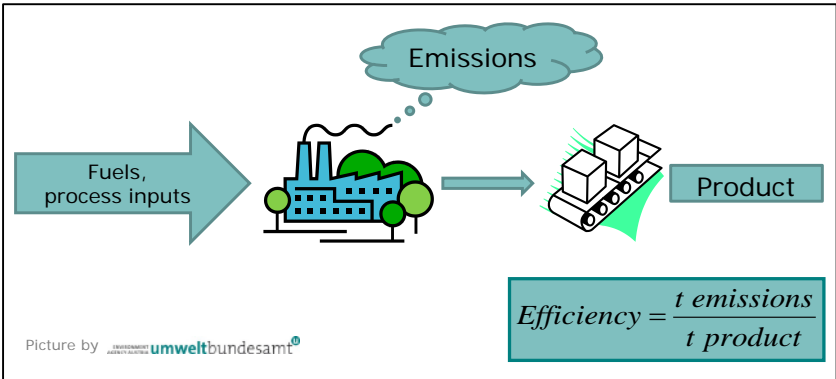

Figure 6: Approach to benchmarking of a simple production process in an installation producing only one type of product.

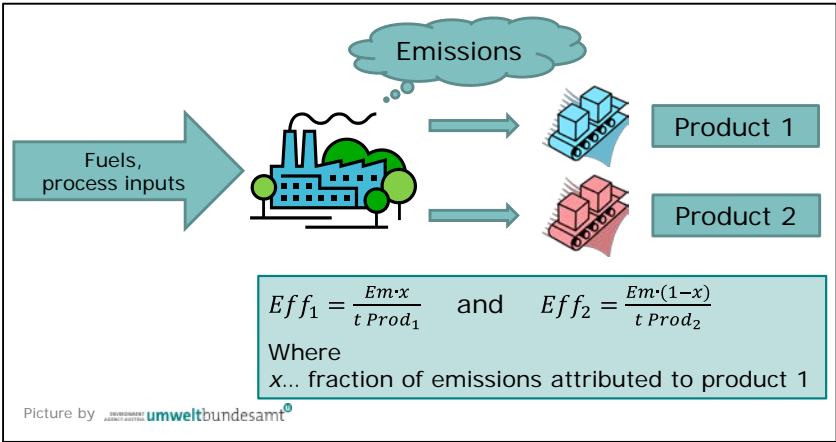

Figure 7: For benchmarking of an installation with two products, an approach is required to split emissions according to the two products. (Eff...efficiency; Em...emissions)

However, the typical installation in the EU ETS produces more than one product. In this context (“measurable”) heat⁹⁴ used for other processes than the main product’s production and electricity should also be considered “products”. In such case, as illustrated by Figure 7, it is necessary to split the emissions by making meaningful measurements or assumptions, before the GHG efficiency (emissions/production) can be calculated.

⁹⁴ For more information on the term “measurable heat” see sections 4.7 and 6.9.

In the EU ETS the enabling concept for providing such emission splits is called “**sub-installations**”. It has been designed to make many different situations of installations comparable within one single benchmark, such as:

- Installations which produce only one product (which have only one sub-installation) as compared to installations with several sub-installations;
- Installations that use fuels directly in the process, as compared to installations that use fuels for producing measurable heat, or import heat from other installations, before the heat is used in the production process;

Furthermore, the concept allows the split between product-related emissions in both of the following situations:

- Production processes happen consecutively, i.e. product A is used to produce product B;
- Production processes which happen simultaneously, e.g. where one chemical reaction gives two separate products, but at least one of these products might also be produced separately (e.g. from other raw materials).

From the above it is demonstrated that sub-installations are a different concept to just an assignment of physical units within an installation, although there is some overlap between these concepts. The shortest possible description of a sub-installation would be:

A **sub-installation** is described by system boundaries of a mass and energy balance, encompassing inputs, outputs and emissions for the purpose of ensuring that benchmarks can be determined for a product or group of products, independent of which other products (including heat or electricity) are produced in the same installation, if any.

The same concept is further developed for the FAR “fall-back approaches”, i.e. rules for allocation to parts of installations that are not covered by product benchmarks (see section 7.2).

The above definition hints at an abstraction from other concepts for dividing installations, in particular division based on physical units such as boilers, kilns, distillation columns, CHP⁹⁵ units etc. The difference can be one in space (one sub-installation can encompass several units⁹⁶, but also one physical unit can serve several sub-installations⁹⁷), but also with regard to the time dimension (one and the same physical unit can be used consecutively for different sub-installations⁹⁸). A detailed example of the split of an installation into sub-installations is presented in section 4.5. Further examples (including further steps to calculate the allocation) can be found in guidance document No. 2.

⁹⁵ Combined Heat and Power production, also referred to as cogeneration.

⁹⁶ E.g. the mineral oil refinery benchmark may encompass a dozen or more units situated on a site of some km².

⁹⁷ E.g. where a boiler produces steam that is used for heating several production processes belonging to different other sub-installations.

⁹⁸ E.g. where in one reactor different chemicals are produced throughout the year, or where a paper machine can be switched between various paper grades.

7.2 Product benchmarks and “fall-back” sub-installations

The EU ETS Directive requires in Article 10a(1) that the Commission “*shall, to the extent feasible, determine Union wide ex-ante benchmarks*” for products. The insertion “to the extent feasible” takes into account that from the beginning of the discussion about benchmark-based allocation, it was expected that there are too many different products made in installations covered by the EU ETS to reasonably establish benchmarks for all of them. And indeed, the list of 52 product benchmarks that is found in the FAR (as well as in the CIMs previously) as agreed with the relevant industry associations covered only two thirds of the allocations in the third phase. For the rest, other pragmatic approaches (“fall-back” approaches) were developed.

For understanding why the FAR establish a clear hierarchy between the different approaches, it needs to be recalled that the product benchmarks are the concept that compare GHG efficiency to the fullest extent: They take into account the efficiency of the energy consumption in the production process, the efficiency of the energy conversion from fuel to heat, as well as the GHG intensity of the fuels used.

The “fall-back” approaches take fewer elements of GHG efficiency into account, as summarised by Table 2:

- Since most energy-intensive industrial processes (the main focus of the EU ETS) consume heat (in the form of steam, hot water etc.), a “**heat benchmark**” can be applied to such processes. This does not provide a complete efficiency benchmark in relation to the final product, because the element of “amount of heat consumed per tonne of product” is not within its scope. It does, however, reward efficiency in heat generation as well as the GHG emission factor of the fuel mix.
- In many cases heat is consumed as the main process relevant for efficiency, but without first generating “measurable heat” in a heat medium. Instead, heat is provided directly in the process, e.g. by a burner located directly in a kiln, oven, dryer, etc. This “non-measurable heat” is accounted for in the “**fuel benchmark**”. It takes into account the GHG intensity of the fuels used, but does not reward efficiency of energy conversion or specific energy consumption levels.
- Finally, for **process emissions**, which are not related to energy consumption, but to chemical reactions other than combustion, no efficiency criterion is applied.

In line with the above, the product benchmark is most preferable, to be applied in the allocation rules as first option, giving the most complete realisation of the benchmarking concept. Next comes the heat benchmark, followed by the fuel benchmark, whereas the process emissions should only be used for filling gaps if all other options are exhausted.

Table 2: Comparison of product benchmark and fall-back approaches regarding which GHG efficiency elements they take into account

	Final energy consumption	Energy conversion efficiency	Fuel choice
Product benchmark	✓	✓	✓
Heat benchmark	✗	✓	✓
Fuel benchmark	✗	✗	✓
Historical emissions	✗	✗	✗

7.3 Attributed emissions

For the purpose of updating the benchmark values (i.e. for generating new benchmark curves), more than just the direct emissions of a sub-installation needs to be taken into account. This is because the aim is to compare the “real” emissions (to the extent these are known) for the complete production process with its peers, but only for the production of this one product. The aim is that the specific GHG emissions per tonne of product from each installation have to be made comparable to each other, i.e. system boundaries must be strictly consistent, and related rules must be obeyed by operators.

The methodology for attributing emissions to the sub-installation (i.e. to the benchmarked product) must ensure that efficiency measures are reflected appropriately. This means that a more efficient installation has a lower value for t GHG / t product. For that purpose, e.g. export of heat leads to a deduction from the attributed emissions of the sub-installation concerned, because heat is a second product which gets its own allocation either under a heat benchmark or as part of another product benchmark sub-installation where the heat is imported and consumed, and to which an emissions equivalent for this imported heat is added. The rules are consistent in that the total amount of attributed emissions of sub-installations adds up to the total emissions of the installation (with the exceptions mentioned in the box on page 22).

Furthermore, the methodology must be able to compare different situations such as production in a stand-alone installation (where only one product is produced) and production in a more integrated installation. The production of heat must be accounted for in the same way if provided either by direct heating with fuels or if delivered via a heat transfer medium (“measurable heat”), no matter if the latter is produced in the installation by a boiler or a CHP process, or if the heat is imported from another installation.

These methodological requirements are implemented by calculating the “attributed emissions” of each sub-installation as follows (not all terms are relevant for all types of sub-installations):

$$AttrEm = DirEm^* + Em_{H,import} - Em_{H,export} + WG_{corr,import} - WG_{corr,export} + Em_{el,exch} - Em_{el,produced}$$

The variables of this equation are explained as follows:

AttrEm: Attributed emissions of the sub-installation.

DirEm* Directly attributable emissions⁹⁹ as linked to source streams of the MP under the MRR, with the following exceptions:

- Measurable heat: Wherever fuels are used to produce measurable heat which is consumed in more than one sub-installation (which includes situations with imports from and exports to other installations), the fuels are not included in the directly attributable emissions of the sub-installation. Instead, the approach outlined below (under “ $Em_{H,import}$ ”) is applied. Only where the heat is exclusively produced for one sub-installation, may the emissions be directly attributed to the sub-installations via the fuel’s emissions. This is the case if the technical unit¹⁰⁰, in which the heat is produced, is clearly within the boundaries of only the one sub-installation.
- Waste gases which are imported from other installations are usually included in the MP. However, not their full emissions are attributable, but only the “consumer” part, which is done using the point “ $WG_{corr,import}$ ” as outlined below. They should therefore be excluded from the calculation of $DirEm^*$. However, waste gases which are produced and fully consumed within the sub-installation are included here^{101,102}. The emissions from waste gases which are produced in and exported from the sub-installation are included here as well but only as a first step. They are subsequently corrected using the term “ $WG_{corr,export}$ ” (s. below).
- Therefore the following equation applies:

$$DirEm^* = DirEm_{total} - Em_{F,heat\ suppl} - Em_{WG,inst.import}$$

where $DirEm_{total}$ are the total directly attributable emissions from source streams (including “internal source streams” if applicable, see below), $Em_{F,heat\ suppl}$ are the emissions from fuels used for supply of measurable heat where the heat is not consumed only by one sub-installation, and

⁹⁹ The alternative term “direct emissions” could be perceived confusing, as in the FAR the term is used only in the context of electricity exchangeability. It must however be kept in mind that the term is here used in a very specific way for the purpose of this formula only. This is the reason why it is designated with an asterisk (*), indicating that a specific meaning has been given to $DirEm^*$.

¹⁰⁰ If it is a CHP unit, the rules for splitting its emissions into part attributable to heat and to electricity need to be respected, see section 6.10.

¹⁰¹ Because the waste gas is produced and consumed within the same system boundaries, the direct emissions of the waste gas are net zero. This can be illustrated by the following example: In an organic chemical process raw material R is partially oxidised for giving product P and a waste gas W. W is incinerated for providing energy to the process. Thus, the mass balance under the MRR would give:

$$Em = M(CO_2)/M(C) \times [C(R) - C(W) + C(W) - C(P)] = M(CO_2)/M(C) \times [C(R) - C(P)],$$

where $M(CO_2)/M(C)$ is the ratio of molar mass of CO_2 and carbon, respectively, and $C(x)$ is the carbon contained in material x. As can be seen, the waste gas W does not have to be monitored.

¹⁰² In this specific case, it does not matter whether waste gases are flared or used within the process.

$Em_{WG,inst.import}$ are emissions related to waste gases imported at installation level.

The directly attributable emissions are monitored in line with the MP approved under the MRR, i.e. taking into account the emissions from calculation-based methodologies (using source streams), measurement-based methodologies (CEMS) as well as no-tier approaches (“fall-backs”). Where the resulting emissions need to be split against several sub-installations, the operator has to use additional measuring instruments for determining the quantities of source streams used in each sub-installation, or establish calculation or estimation methods for performing this split.

Additional monitoring is required for “internal source streams”, i.e. source streams that are produced within one sub-installation and used in another, with the exception of waste gases which are corrected for as outlined below. Such source streams usually do not appear in the MP¹⁰³, such as coke produced in the coke sub-installation and consumed in a hot metal sub-installation within the same installation. For internal source streams adequate monitoring methods have to be included in the MMP. The baseline data template also uses the term “internal source streams”, with specific input fields for each sub-installation.

$Em_{H,import}$

Emissions related to the attribution of measurable heat imported to the sub-installation. This includes import from other installations, other sub-installations as well as heat received from a technical unit (e.g. a central power house at the installation, or a more complex steam network with several heat producing units) that supplies heat to more than one sub-installation. The heat from such units is included under “import” for transparency purposes.

Emissions from heat imported are calculated, as applicable, by one of the following methods:

- Where the quantity of fuel used and the emission factor of the fuel mix used for the heat production are known (which is usually the case where the heat is produced within the installation), the respective emissions are attributed by the operator accordingly.
The same applies where heat is imported from other installations, but where the operator of the receiving installation receives the relevant fuel mix information from the operator of the heat producer.
- For imports of heat from non-EU ETS installations and for heat recovered from other processes (other sub-installations), the real emissions might either be unknown or not clearly defined, because data such as generation efficiency and emission factor of the fuel mix are often unknown. Instead, in

¹⁰³ In some installations these source streams are already monitored, e.g. where significant stock piles exist which help levelling different production between reporting years.

these cases the FAR require the operator to report only the quantity of heat without attributing the emissions¹⁰⁴.

The same applies for heat produced within a nitric acid sub-installation and heat from electrical boilers with regard to updating the benchmark of the receiving installation. Note, however, that such heat is treated like non-EU ETS heat for the purpose of allocation, i.e. not eligible for allocation.

Em_{H,export} Emissions related to the attribution of measurable heat exported from the sub-installation. In contrast to what has been said for *Em_{H,import}*, the emissions attributed to exported heat are always determined based on the (updated) heat benchmark. Similar to what is said above for *Em_{H,import}*, for heat recovered and exported from product benchmark or fuel benchmark sub-installations, the real emissions might either be unknown or not clearly defined. For those cases the FAR require the operator to report only the quantity of heat without attributing the emissions.

WG_{corr,import} Correction for imported waste gases: Under the MRR the direct emitter is fully responsible for the emissions. This would mean that a unit that combusts a waste gas has to report the full emissions of the waste gas. However, for the purposes of the FAR, emissions of waste gases are split between the producing and the consuming sub-installation. For the import, i.e. use of the waste gas, the relevant attributable emissions are not included under *DirEm** above but are calculated as

$$WG_{corr,import} = V_{WG} \cdot NCV_{WG} \cdot BM_F$$

where V_{WG} is the volume of the waste gas imported, NCV_{WG} its net calorific value, and BM_F the (updated) fuel benchmark. Note that where the waste gas is not directly consumed in a sub-installation but used for the production of measurable heat as an intermediate product, this rule does not apply. Instead, the rule for attributing emissions related to import of measurable heat applies (see above "*Em_{H,import}*").

Note that in the case of the fuel benchmark sub-installation, the volume of waste gas that is flared for non-safety flaring purposes is *not* taken into account (i.e. it is subtracted from the volume imported).

WG_{corr,export} Correction for exported waste gases: For the purposes of the FAR, emissions of waste gases are split between the producing and the consuming sub-installation. Where a waste gas is produced in the sub-installation, its full emissions are already included in the sub-installation's attributed emissions, as a consequence of the source streams included in *DirEm**. Therefore a correction is only required for any volume exported¹⁰⁵. For the export of, i.e.

¹⁰⁴ Note that in such cases a "qualitative attribution" of the emissions take place: The obligation to carry out the attribution to the sub-installation should be considered as fulfilled, despite the fact that they are not quantified.

¹⁰⁵ The correction takes into account that the consumer of the waste gas should be put on equal footing with other installations using natural gas, and correcting for the two different efficiencies typical for the use of the gases.

use of the waste gas elsewhere, the relevant attributable emissions to be subtracted are calculated as

$$Em_{WG} = V_{WG,exported} \cdot NCV_{WG} \cdot EF_{NG} \cdot Corr_{\eta}$$

where $V_{WG,exported}$ is the volume of waste gas exported from the sub-installation, expressed as Nm^3 or t, NCV_{WG} is the net calorific value of the waste gas expressed as TJ/ Nm^3 or TJ/t as consistent with the unit used for V , EF_{NG} is the emission factor of natural gas (56.1 t CO₂/TJ), and $Corr_{\eta}$ is a factor that accounts for the difference in efficiencies between the use of waste gas and the use of the reference fuel natural gas. The default value of this factor is 0.667.

Em_{el,exch}

Emissions equivalent to the “exchangeable” electricity quantity. There are processes in the EU ETS for which different installations consume heat either produced by fuel or produced by electricity. This situation is termed “exchangeability of fuels and electricity”, and a specific allocation rule aims at treating these situations equally (Article 22 of the FAR). Several product benchmarks in Annex I of the FAR are indicated to fall within this category, and the boundaries are given regarding which processes are concerned.

The amount of electricity consumed within these latter boundaries defined in the FAR has to be monitored and reported by the operator in order to deliver the appropriate attributed emissions for updating the benchmark values. The attributable emissions $Em_{el,exch}$ (termed “indirect emissions” in the FAR) are calculated as follows:

$$Em_{el,exch} = El_{cons,exch} \cdot EF_{El}$$

Where $El_{cons,exch}$ is the amount of exchangeable electricity consumed, expressed in MWh, and EF_{El} is the EU-wide average emission factor for electricity production, which is given by the FAR as $EF_{El} = 0.376$ t CO₂ / MWh.

Em_{el,produced}

Emissions equivalent to the electricity produced in a sub-installation. It has to be noted that this only covers electricity that is produced other than via the intermediate production of measurable heat (e.g. via steam). This includes electricity that is produced e.g. from expansion of compressed gases via an expansion turbine. Any electricity that is produced via measurable heat has already been deducted under $Em_{H,export}$ above.

The attributable emissions $Em_{el,produced}$ are calculated as follows:

$$Em_{el,produced} = El_{produced} \cdot EF_{El}$$

Where $El_{produced}$ is the amount of electricity produced other than electricity produced via measurable heat, expressed in MWh, and EF_{El} is the EU-wide average emission factor for electricity production, which is given by the FAR as $EF_{El} = 0.376$ t CO₂ / MWh.

7.3.1 Examples: General introduction







The table below links each element of the AttrEm formula above with the relevant sections in the baseline data collection and MMP templates, as well as with the relevant examples shown in this section.

Table 3: Relation between the different variables of AttrEm and the relevant sections in the Commission’s baseline data collection and MMP template. (Further parameters included in the table concern entries that are required to be provided in the “BM update” section of the baseline data collection template for consistency checks or other purposes, but do not have a direct impact on AttrEm).

Attributed emissions	Relevant section in the baseline data collection template		Relevant section in the MMP Template		Relevant examples in this section
	Product BM	Fallback BM ¹⁰⁶	Product BM	Fallback BM	
<i>DirEm*</i> (MP source streams)	F.g	G.c	F.e.i	G.c	All
<i>DirEm*</i> (Internal source streams)	F.i	–	F.e.ii	–	WG-1
<i>DirEm*</i> (CO ₂ feedstock)	F.j	–	F.e.iii	–	–
<i>Em_{H,import}</i>	F.k.i	G.1.f	F.g	G.1.f	MH(all), WG-3, Elec-2
<i>Em_{H,export}</i>	F.k.v	G.4.e	F.g	G.4.e	MH(all)
<i>WG_{corr,import}</i>	F.l.xx	G.4.d	F.h	G.4.d	WG(all)
<i>WG_{corr,export}</i>	F.l.xxv	–	F.h	–	WG(all)
<i>Em_{el,exch}</i>	F.c	–	F.c	–	Elec-1
<i>Em_{el,prod}</i>	F.m	–	F.c	–	Elec-2
<i>Parameter: Fuel input</i>	F.h	G.d.i	F.f	G.d	All
<i>Parameter: Fuel input from waste gases (WG)</i>	F.k	G.d.iii	F.h	G.d	WG(all)
<i>Parameter: Heat produced</i>	–	G.	–	G.e	MH-5
<i>Parameter: Heat from pulp</i>	F.k.iii	G.1.f	F.g	G.1.f	MH-3
<i>Parameter: Heat from nitric acid</i>	F.k.iv	–	–	–	MH-3
<i>Parameter: Waste gases produced</i>	F.l.v	–	F.h	–	WG(all)
<i>Parameter: Waste gases consumed</i>	F.k.x	–	F.h	–	WG(all)
<i>Parameter: Waste gases flared</i>	F.l.xv	–	F.h	–	WG(all)
<i>Parameter: Total pulp produced</i>	F.n	–	F.a	–	MH-3
<i>Parameter: Intermediate products</i>	F.o	–	F.a	–	-

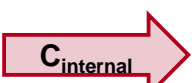
¹⁰⁶ Where reference is made to the specific type of fall-back benchmark, relevant sections apply to all sub-installations with the same benchmark, e.g. “G.1.f” means that this is the relevant section for the heat and district heating sub-installations; “G.4.d” means this is the relevant section for the fuel BM sub-installations.

The table below shows the colour-coding for all fuels, material and heat flows used in the examples in this section. The tables in the examples indicate in which sections of the baseline data template the data should be entered and which type of data.

Arrow type	Description
	Green arrows are used for source streams ¹⁰⁷ found in the MP under the MRR (“MP source streams”).
	Grey arrows are used for fuels which are combusted outside the system boundaries of the installation, i.e. not covered by the MP under the MRR.
	Light red arrows are used for “internal source streams” which are not covered by the MP (e.g. because a mass balance is applied over the whole installation).
	Dark blue arrows are used for measurable heat flows.
	Blue arrows are used for products, e.g. product BM products.
	Red arrows are used for electricity flows.

7.3.2 Examples: Fuel and material input only (FM)

The figure and table below explain for the simple and general case of an installation that is consuming fuels directly (non-measurable heat excluding fuel input from waste gases¹⁰⁸) and how the attribution to each sub-installation for the purpose of determining attributed emissions should be done in the baseline data template, and how the calculation works. Fuel type 2 in the example (Fuel₂) is used in two different sub-installations; respective energy inputs are Fuel_{2,1} and Fuel_{2,2}.

This situation would occur for a broad range of sectors, for example, in the cement industry (e.g. sub A = clinker, sub B = fuel BM sub-installation (e.g. cement mill)), ceramic industry (e.g. sub A = bricks, pavers, or tiles), glass industry (e.g. sub A = float glass or coloured/colourless glass), etc.

¹⁰⁷ This includes all source streams, i.e. regardless of whether a standard methodology in accordance with Article 24 MRR (fuel and process material) or a mass balance in accordance with Article 25 MRR is applied.

¹⁰⁸ Rules for measurable heat and waste gas flows are shown in examples MH and WG.

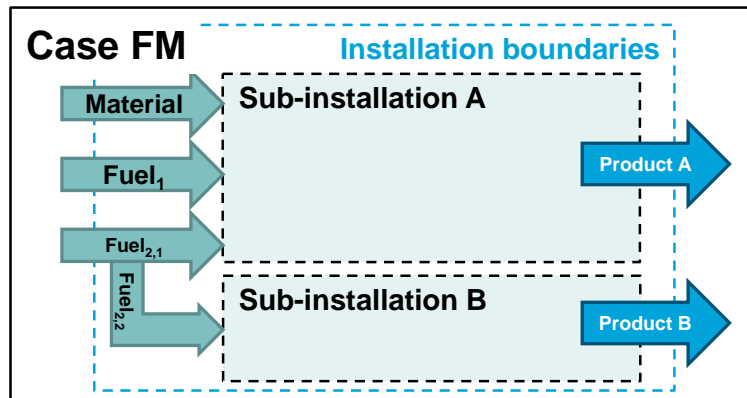

Figure 8: Example case FM

Table 4: Calculation of attribution of emissions for case FM

Attributed emissions	Sub A	Sub B
<i>DirEm*</i>	$Fuel_1 \times EF_{F1} + Fuel_{2,1} \times EF_{F2} + Material \times EF_{material}$	$Fuel_{2,2} \times EF_{F2}$
<i>All other parameters</i>	0 or "not relevant"	0 or "not relevant"
<i>AttrEm</i>	Sum of the above	–
<i>Parameter: Fuel input</i>	$Fuel_1 + Fuel_{2,1}$	$Fuel_{2,2}$
<i>Parameter: Fuel input (weighted EF)</i>	$(Fuel_1 \times EF_{F1} + Fuel_{2,1} \times EF_{F2}) / \text{"Fuel input"}$	EF_{F2}

7.3.3 Examples: Measurable heat flows (MH)

Rules for import and export of measurable heat – Introduction

The figures and tables below explain for each case how the attribution of fuels and heat to each sub-installation for the purpose of determining attributed emissions should be done in the baseline data template, and how the calculation works. In each case, sub-installations consume fuels (non-measurable heat) or (measurable) heat. The cases are as follows:

- **Case MH-1:** The installation has only one sub-installation. Heat is imported from another installation.
- **Case MH-2:** Similar to case MH-1 but the heat is produced within the installation under consideration.
- **Case MH-3:** Heat is exported from one sub-installation (e.g. recovery of waste heat) and consumed by another sub-installation within the same installation.
- **Case MH-4:** Similar to case MH-2, but the heat produced is consumed by two sub-installations.
- **Case MH-5:** Similar to case MH-4, but shows details on how to account for heat losses.
- **Case MH-6:** Similar to case MH-2, but the heat is produced by a CHP.

These situations would occur for a broad range of sectors, for example, in the pulp and paper industry (e.g. case MH-1 heat imported from a connected CHP plant for paper production), gas transport industry (e.g. case MH-3, sub A = fuel BM sub-installation for gas compressor station, sub B = district heating sub-installation from recovered waste heat), etc.

Rules for import and export of measurable heat – Case MH-1

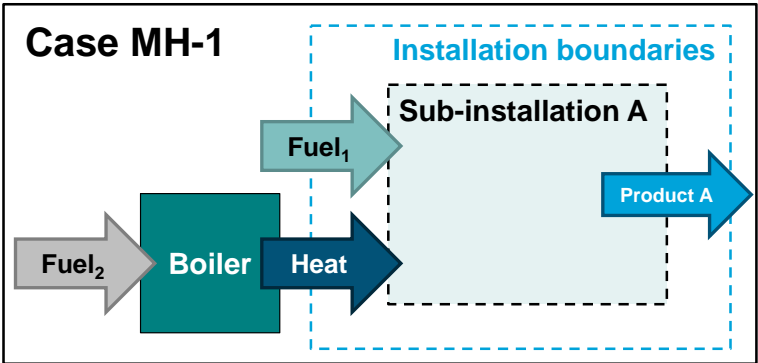

Figure 9: Example case MH-1 on attributed emissions (measurable heat).

Table 5: Calculation of attribution of emissions for case MH-1 (measurable heat)

Attributed emissions	Sub A	Sub B
<i>DirEm*</i>	Fuel ₁ x EF _{F1}	–
<i>Em_{H,import}</i>	+ Heat x EF _{imported heat} (†)	–
<i>Em_{H,export}</i>	0	–
<i>All other parameters</i>	0 or “not relevant”	0 or “not relevant”
AttrEm	Sum of the above	–
<i>Parameter: Fuel input</i>	Fuel ₁	–
<i>Parameter: Fuel input (weighted EF)</i>	EF _{F1}	–

†EF_{imported heat}: this information needs to be obtained from the supplier. If this information is not provided, or not sufficiently supported by corresponding evidence, entries for the emission factor should be left empty. This is also the case if the EF cannot be determined, e.g. if it concerns measurable heat recovered from product benchmark sub-installations. Note that data entries here would not change if the heat supplier was not covered by the EU ETS or the heat came from nitric acid production. This would only have an impact on the allocation but not on the attributable emissions.

Rules for import and export of measurable heat – Case MH-2

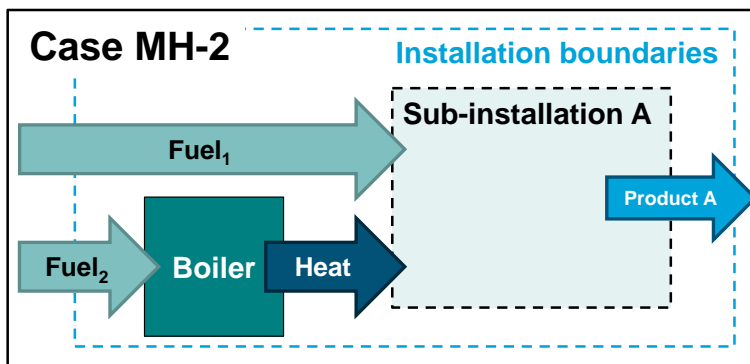

Figure 10: Example case MH-2 on attributed emissions (measurable heat).

Table 6: Calculation of attribution of emissions for case MH-2 (measurable heat)

Attributed emissions	Sub A	Sub B
<i>DirEm*</i>	$Fuel_1 \times EF_{F1} + Fuel_2 \times EF_{F2}$	–
<i>Em_{H,import}</i>	0	–
<i>Em_{H,export}</i>	0	–
<i>All other parameters</i>	0 or “not relevant”	0 or “not relevant”
<i>AttrEm</i>	Sum of the above	–
Parameter: Fuel input	$Fuel_1 + Fuel_2$	–
Parameter: Fuel input (weighted EF)	$(Fuel_1 \times EF_{F1} + Fuel_2 \times EF_{F2}) /$ “Fuel input”	–

Rules for import and export of measurable heat – Case MH-3

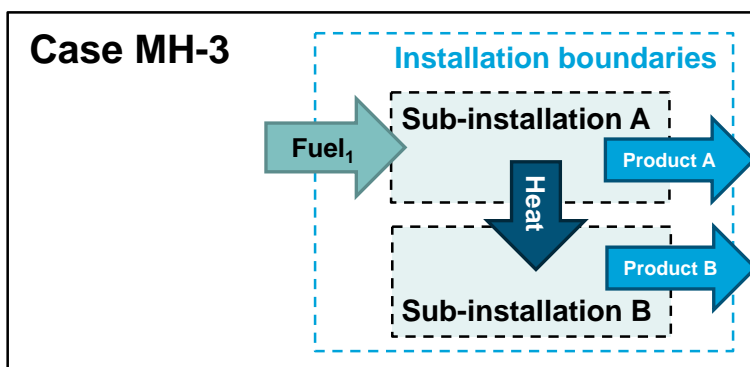

Figure 11: Example case MH-3 on attributed emissions (measurable heat).

Table 7: Calculation of attribution of emissions for case MH-3 (measurable heat)

Attributed emissions	Sub A	Sub B
<i>DirEm*</i>	Fuel ₁ x EF _{F1}	0
<i>Em_{H,import}</i>	0	+ Heat x EF _{exported heat} (†)
<i>Em_{H,export}</i>	- Heat x EF _{exported heat} (†)	0
All other parameters	0 or "not relevant"	0 or "not relevant"
AttrEm	Sum of the above	Sum of the above
Parameter: Fuel input	Fuel ₁	0
Parameter: Fuel input (weighted EF)	EF _{F1}	0

†EF_{exported heat}: There are cases where the emission factor associated with the heat export is not known or cannot be determined, e.g. if it concerns recovered heat from flue gases from product benchmark sub-installations. In such cases the entry field for the emission factor should be left empty. If sub A is a fuel benchmark sub-installation from which heat is recovered for e.g. district heating (sub B), the emission factor should be determined by assuming a virtual efficiency of the heat production of 90% (EF_{exported heat} = EF_{F1} / 90%).

Further parameters: If sub-installation A were producing pulp or nitric acid, imported amounts (Heat) would also have to be listed for sub-installation B under "Parameter: Heat from pulp", or "Parameter: Heat from nitric acid", respectively. In the case of sub-installation A producing pulp, "Parameter: Total pulp produced" needs to be provided.

Rules for import and export of measurable heat – Case MH-4

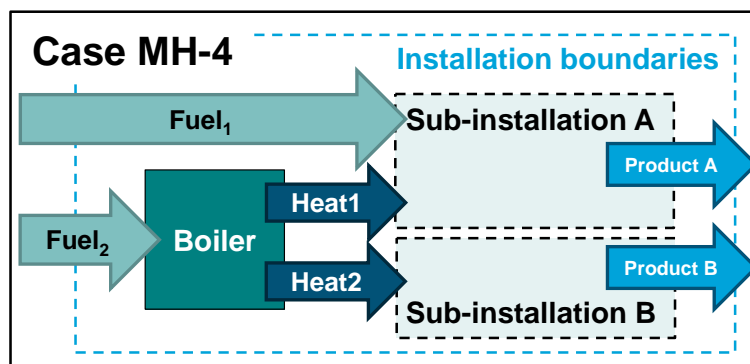

Figure 12: Example case MH-4 on attributed emissions (measurable heat).

Table 8: Calculation of attribution of emissions for case MH-4 (measurable heat)

Attributed emissions	Sub A	Sub B
<i>DirEm*</i>	Fuel ₁ x EF _{F1}	0
<i>Em_{H,import}</i>	+ Heat ₁ x EF _{heat} (†)	+ Heat ₂ x EF _{heat} (††)
<i>Em_{H,export}</i>	0	0
All other parameters	0 or "not relevant"	0 or "not relevant"
AttrEm	Sum of the above	Sum of the above
Parameter: Fuel input	Fuel ₁	0
Parameter: Fuel input (weighted EF)	EF _{F1}	0

†With EF_{heat} = EF_{F2} / η_H

††The same EF_{heat} applies to both sub-installations, and Heat₂ can be calculated as difference from the total heat. Therefore Heat₂ x EF_{heat} = (Fuel₂ x η_H - Heat₁) x EF_{heat}

Rules for import and export of measurable heat – Case MH-5

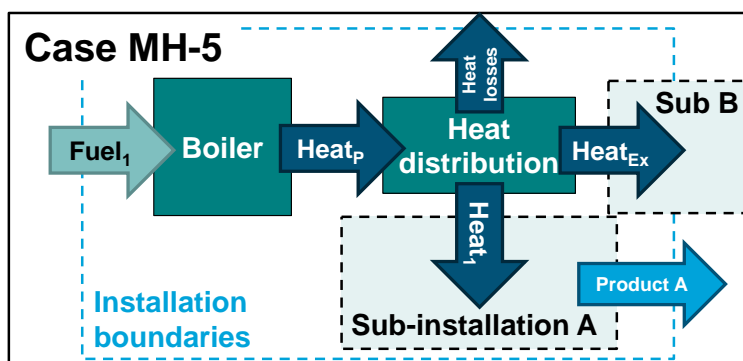

Figure 13: Example case MH-5 on attributed emissions (measurable heat).

Table 9: Calculation of attribution of emissions for case MH-5 (measurable heat)

Attributed emissions	Sub A	Sub B
<i>DirEm*</i>	0	0
<i>Em_{H,import}</i>	+ Heat ₁ x EF _{heat,P} x [Heat _P /(Heat ₁ +Heat _{Ex})] (+)	+ Heat _{Ex} x EF _{heat,P} x [Heat _P /(Heat ₁ +Heat _{Ex})] (++)
<i>Em_{H,export}</i>	0	0
<i>All other parameters</i>	0 or "not relevant"	0 or "not relevant"
<i>AttrEm</i>	Sum of the above	Sum of the above
<i>Parameter: Fuel input</i>	0	0
<i>Parameter: Fuel input (weighted EF)</i>	0	0
<i>Parameter: Heat produced (+++)</i>	Heat ₁ x [Heat _P /(Heat ₁ +Heat _{Ex})]	Heat _{Ex} x [Heat _P /(Heat ₁ +Heat _{Ex})]

†With $EF_{heat,P} = EF_{F1} / \eta_H$.

++The same $EF_{heat,P}$ applies to both sub-installations. The term $Heat_P / (Heat_1 + Heat_{Ex})$ is to account for heat losses in accordance with section 10.1.3 of Annex VII of the FAR.

+++For sub-installation A, this parameter is only relevant if it concerns a heat BM or district heating sub-installation. Sub-installation B is per definition always one of these sub-installations¹⁰⁹.

¹⁰⁹ Note: even if measurable heat is exported such as in the case of the district heating sub-installation (which is reflected in the activity level), for the purpose of the attribution of emissions, the associated emissions have to be considered as "input" ("imported") under $Em_{H,import}$ following the visual display of the system boundaries as depicted in MH-5.

Rules for import and export of measurable heat – Case MH-6

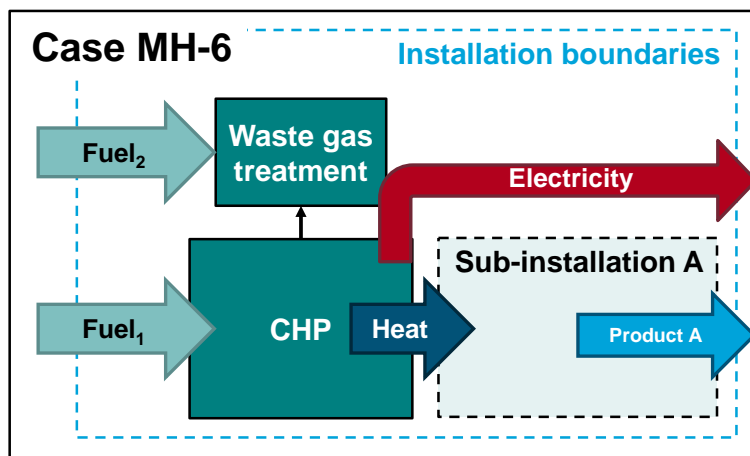

Figure 14: Example case MH-6 on attributed emissions (measurable heat).

Table 10: Calculation of attribution of emissions for case MH-6 (measurable heat)

Attributed emissions	Sub A	Sub B
<i>DirEm*</i>	$Em_{CHP,heat} (\dagger)$	–
$Em_{H,import}$	0	–
$Em_{H,export}$	0	–
All other parameters	0 or “not relevant”	–
AttrEm	Sum of the above	–
Parameter: Fuel input	$Fuel_{CHP,heat} (\dagger\dagger)$	–
Parameter: Fuel input (weighted EF)	$Em_{CHP,heat} / Fuel_{CHP,heat}$	–
Parameter: Heat produced	Heat	–

$\dagger Em_{CHP,heat}$ are the emissions associated with the heat output of the CHP and are determined in accordance with the methodology described in section 6.10. This figure is one of the main results of the “CHP Tool” in the baseline data collection template (see example below).

$\dagger\dagger Fuel_{CHP,heat}$ is the share of the fuel input that is attributable to the heat production (see example below).

In order to correctly calculate the parameters above, the rules for splitting fuel input and emissions to heat and electricity production in accordance with chapter 8 of Annex VII of the FAR are needed. These are explained in section 6.10 and the following example should help to explain what data needs to be entered in the “CHP Tool” in the baseline data collection template to obtain the relevant parameters.

Example: Fuel₁ and Fuel₂ are natural gas of which 100 TJ are fired in the CHP and 2 TJ are used for flue gas cleaning. The annual output of heat and electricity is 60 TJ and 20 TJ, respectively. The fuel’s total emissions correspond to 5,712 t CO₂ per year using the emission factor of natural gas. The screenshot below shows the results to be entered in the table above:

- $Em_{CHP,heat}$ would correspond to the value of 3,634.91 t CO₂ under the emissions attributable to the heat output under (h).i.
- $Fuel_{CHP,heat}$ would correspond to the value of 64.91 TJ under fuel input for heat under (i).i.

Were CHP outside the installation and heat were imported from it (like in case MH-1), the corresponding emissions would have to be provided under $Em_{H,import}$ with “Heat x EF_{heat} ”. EF_{heat} in that example would correspond to the value of 60.58 t CO₂ / TJ as provided under (h).ii.

(a) Total amount of fuel input into CHP units		
	Unit	2014
Fuel input into CHP	TJ / year	102,00
(b) Heat output from CHP		
	Unit	2014
Heat output from CHP	TJ / year	60,00
(c) Electricity output CHP		
	Unit	2014
Electricity output CHP	TJ / year	20,00
(d) Total emissions from CHP		
	Unit	2014
i. From fuel input to CHP	t CO ₂ / year	5.600,00
ii. From flue gas cleaning	t CO ₂ / year	112,00
iii. Total emissions	t CO ₂ / year	5.712,00
(e) Default efficiencies: Heat: <input type="text"/>		
(f) Efficiencies for heat and electricity		
	Unit	2014
i. Heat production	-	0,5882
ii. Electricity production	-	0,1961
(g) Reference efficiencies		
	Unit	2014
i. Heat production	-	90,00%
ii. Electricity production	-	52,50%
(h) Emissions attributable to heat production from CHP		
	Unit	2014
i. Emissions attributable to heat output	t CO ₂ / year	3.634,91
ii. Emission factor, heat	t CO ₂ / TJ	60,58
(i) Fuel input attributable to heat and electricity production		
	Unit	2014
i. Fuel input for heat	TJ / year	64,91
ii. Fuel input for electricity	TJ / year	37,09

Figure 15: Example screenshot for the “CHP Tool” in the baseline data collection for case MH-6.

7.3.4 Examples: Waste gases (WG)

Rules for imported and exported waste gases – Introduction

The figures and tables below explain for each case how the attribution of source streams and waste gases each sub-installation for the purpose of determining attributed emissions should be done in the baseline data template, and how the calculation works. The cases are as follows:

- **Case WG-1:** The installation comprises two sub-installations. Sub-installation A exports part of its waste gas to sub-installation B. For the purpose of reporting its annual emissions in accordance with the MRR, the installation uses a mass balance approach (C_{input} and C_{output} denote source streams as contained in the MP under the MRR). $C_{internal}$ is a source stream that is not contained in the MP under the MRR. This may be any carbon-containing material that is transferred between sub-installations before leading to emissions.
- **Case WG-2:** Similar to case 1 but each sub-installation is part of an individual installation. Therefore the material $C_{internal}$ is considered a source stream under both installation's MP, referred to as $C_{output,3}$ here.
- **Case WG-3:** Similar to case 2 but the consumer of the waste gas produces measurable heat from the waste gas which is subsequently consumed in sub-installation B.

This situation would occur, for example, in the iron & steel industry (e.g. sub A = coke, sub B = hot metal) or bulk organic chemical industry, where waste gases arise and emissions are monitored using a mass balance pursuant to Article 25 of the MRR.

Rules for imported and exported waste gases – Case WG-1

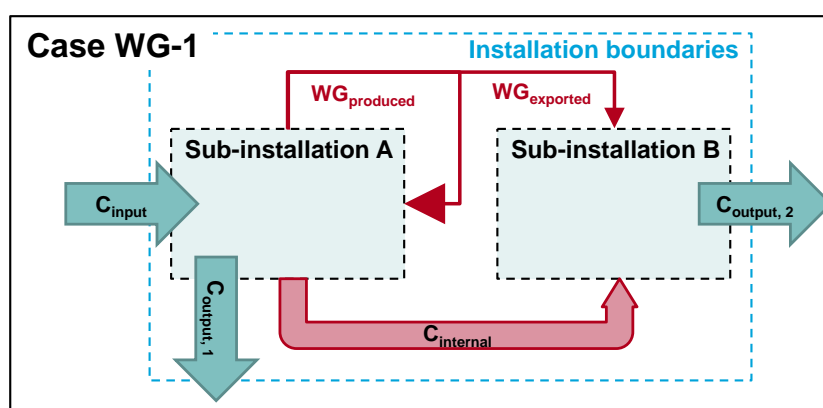

Figure 16: Example case WG-1 on attributed emissions (waste gases).

Table 11: Calculation of attribution of emissions for case WG-1 (waste gases)

Attributed emissions	Sub A	Sub B
<i>DirEm*</i> (MP source streams)	$3.664 \times (C_{input} - C_{output,1})$	$- 3.664 \times C_{output,2}$
<i>DirEm*</i> (Internal source streams)	$- 3.664 \times C_{internal}$	$+ 3.664 \times C_{internal}$
<i>WG_{corr,import}</i>	0	$+ WG_{exported} \times BM_{fuel} (\dagger\dagger)$
<i>WG_{corr,export}</i>	$- WG_{exported} \times EF_{NG} \times CorrF (\dagger)$	0
<i>All other parameters</i>	0 or "not relevant"	0 or "not relevant"
AttrEm	Sum of the above	Sum of the above
Parameter: Fuel input	$Fuel_{C,input}$	$WG_{exported} + Fuel_{C,internal}$
Parameter: Fuel input (weighted EF)	$EF_{C,input}$	$(WG_{exported} \times EF_{WG,exported} + Fuel_{C,internal} \times EF_{C,internal}) /$ "Fuel input"
Parameter: Fuel input from WG	0	$WG_{exported}$
Parameter: Fuel input from WG (EF)	0	$EF_{WG,exported}$
Parameter: Waste gases produced	$WG_{produced}$	0
Parameter: Waste gases produced (EF)	$EF_{WG,produced} = EF_{WG,exported}$	0
Parameter: Waste gases consumed	$WG_{produced} - WG_{exported}$	$WG_{exported}$
Parameter: Waste gases consumed (EF)	$EF_{WG,produced} = EF_{WG,exported}$	$EF_{WG,produced} = EF_{WG,exported}$
Parameter: Waste gases flared	0	0

$\dagger EF_{NG}$ and $CorrF$ will be applied automatically and do not need to be provided in the template. However, the corresponding emissions factor, $EF_{WG,exported}$, needs to be provided for consistency checking.

$\dagger\dagger BM_{fuel}$ will be applied automatically and does not need to be provided in the template. However, the corresponding emissions factor, $EF_{WG,exported}$, needs to be provided for consistency checking.

Rules for imported and exported waste gases – Case WG-2

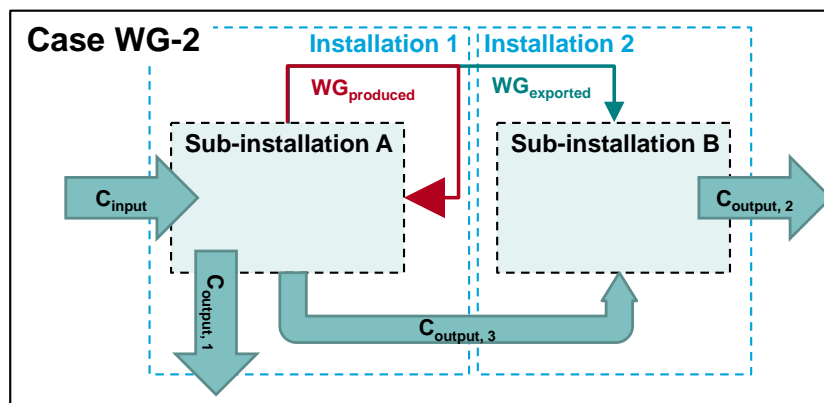

Figure 17: Example case WG-2 on attributed emissions (waste gases).

Table 12: Calculation of attribution of emissions for case WG-2 (waste gases)

Attributed emissions	Sub A	Sub B
<i>DirEm*</i> (MP source streams)	$3.664 \times (C_{input} - C_{output,1} - C_{output,3})$	$3.664 \times (C_{output,3} - C_{output,2})$
<i>DirEm*</i> (Internal source streams)	0	0
<i>WG_{corr,import}</i>	0	+ $WG_{exported} \times BM_{fuel}$ (++)
<i>WG_{corr,export}</i>	- $WG_{exported} \times EF_{NG} \times CorrF$ (+)	0
<i>All other parameters</i>	0 or "not relevant"	0 or "not relevant"
AttrEm	Sum of the above	Sum of the above
Parameter: Fuel input	$Fuel_{C,input}$	$WG_{exported} + Fuel_{C,output,3}$
Parameter: Fuel input (weighted EF)	$EF_{C,input}$	$(WG_{exported} \times EF_{WG,exported} + Fuel_{C,output,3} \times EF_{C,output,3}) /$ "Fuel input"
Parameter: Fuel input from WG	0	$WG_{exported}$
Parameter: Fuel input from WG (EF)	0	$EF_{WG,exported}$
Parameter: Waste gases produced	$WG_{produced}$	0
Parameter: Waste gases produced (EF)	$EF_{WG,produced} = EF_{WG,exported}$	0
Parameter: Waste gases consumed	$WG_{produced} - WG_{exported}$	$WG_{exported}$
Parameter: Waste gases consumed (EF)	$EF_{WG,produced} = EF_{WG,exported}$	$EF_{WG,produced} = EF_{WG,exported}$
Parameter: Waste gases flared	0	0

+ EF_{NG} and $CorrF$ will be applied automatically and do not need to be provided in the template. However, the corresponding emissions factor, $EF_{WG,exported}$, needs to be provided for consistency checking.

++ BM_{fuel} will be applied automatically and does not need to be provided in the template. However, the corresponding emissions factor, $EF_{WG,exported}$, needs to be provided for consistency checking.

Rules for imported and exported waste gases – Case WG-3

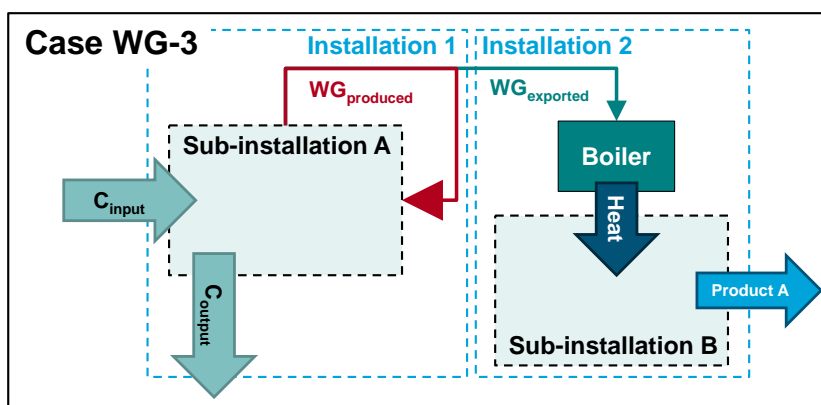

Figure 18: Example case WG-3 on attributed emissions (waste gases).

Table 13: Calculation of attribution of emissions for case WG-3 (waste gases)

Attributed emissions	Sub A	Sub B
<i>DirEm*</i> (MP source streams)	$3.664 \times (C_{input} - C_{output})$	0
<i>DirEm*</i> (Internal source streams)	0	0
<i>Em_{H,import}</i>	0	+ Heat x BM_{heat} (++)
<i>WG_{corr,import}</i>	0	0
<i>WG_{corr,export}</i>	$- WG_{exported} \times EF_{NG} \times CorrF$ (†)	0
All other parameters	0 or “not relevant”	0 or “not relevant”
AttrEm	Sum of the above	Sum of the above
Parameter: Fuel input	<i>Fuel_{C,input}</i>	<i>WG_{exported}</i>
Parameter: Fuel input (weighted EF)	<i>EF_{C,input}</i>	$(WG_{exported} \times EF_{WG,exported}) /$ “Fuel input”
Parameter: Fuel input from WG	0	<i>WG_{exported}</i>
Parameter: Fuel input from WG (EF)	0	<i>EF_{WG,exported}</i>
Parameter: Waste gases produced	<i>WG_{produced}</i>	0
Parameter: Waste gases produced (EF)	$EF_{WG,produced} = EF_{WG,exported}$	0
Parameter: Waste gases consumed	$WG_{produced} - WG_{exported}$	<i>WG_{exported}</i>
Parameter: Waste gases consumed (EF)	$EF_{WG,produced} = EF_{WG,exported}$	$EF_{WG,produced} = EF_{WG,exported}$
Parameter: Waste gases flared	0	0

†*EF_{NG}* and *CorrF* will be applied automatically and do not need to be provided in the template. However, the corresponding emissions factor, *EF_{WG,exported}*, needs to be provided for consistency checking.

++*BM_{heat}* will be applied automatically and does not need to be provided in the template. In order to obtain correct results, the field for the corresponding emission factor must be left empty.

7.3.5 Examples: Electricity (Elec)

Rules for consumed and produced electricity – Introduction

The figures and tables below explain for each case how the attribution of source streams and electricity flows to each sub-installation for the purpose of determining attributed emissions should be done in the baseline data template, and how the calculation works. The cases are as follows:

- **Case Elec-1:** The installation produces one benchmarked product for which the exchangeability of fuel and electricity is relevant. It consumes a fuel and electricity for the production. This case represents the general concept for all product benchmark sub-installations listed in Annex I of the FAR for which the exchangeability of fuels and electricity is relevant.
- **Case Elec-2:** This installation has only one sub-installation consuming fuel for the production of products. Steam is recovered from waste heat and used for the production of electricity. Electricity is also produced directly from depressurising gases in the process via an expansion turbine without an intermediate production of measurable heat.

Rules for consumed electricity – Case Elec-1

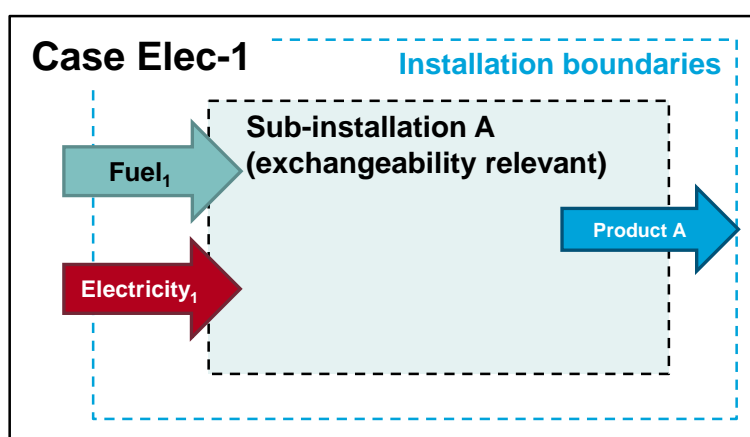

Figure 19: Example case Elec-1 on attributed emissions (electricity).

Table 14: Calculation of attribution of emissions for case Elec-1 (electricity)

Attributed emissions	Sub A	Sub B
<i>DirEm*</i>	$Fuel_1 \times EF_{F1}$	–
<i>Em_{H,export}</i>	0	–
<i>Em_{el,exch}</i>	+ $Electricity_1 \times EF_{el} (\dagger)$	–
<i>Em_{el,produced}</i>	0	–
<i>All other parameters</i>	0 or “not relevant”	–
AttrEm	Sum of the above	–
<i>Parameter: Fuel input</i>	$Fuel_1$	–
<i>Parameter: Fuel input (weighted EF)</i>	EF_{F1}	–

$\dagger EF_{el}$: will be applied automatically and does not need to be provided in the template.

Rules for produced electricity – Case Elec-2

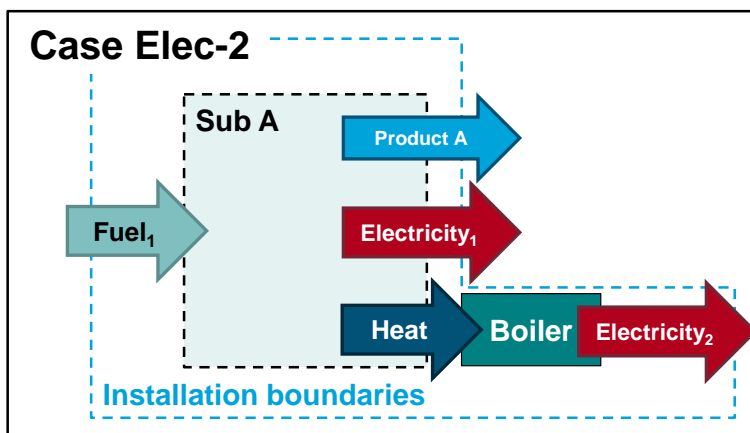

Figure 20: Example case Elec-2 on attributed emissions (electricity).

Table 15: Calculation of attribution of emissions for case Elec-2 (electricity)

Attributed emissions	Sub A	Sub B
<i>DirEm*</i>	Fuel ₁ x EF _{F1}	–
<i>Em_{H,export}</i>	– Heat x EF _{heat} (†)	–
<i>Em_{e,exch}</i>	–	–
<i>Em_{e,produced}</i>	– Electricity ₁ x EF _{el} (††)	–
All other parameters	0 or “not relevant”	–
AttrEm	Sum of the above	–
Parameter: Fuel input	Fuel ₁	–
Parameter: Fuel input (weighted EF)	EF _{F1}	–

†EF_{heat}: There are cases where the emission factor associated with the heat export is not known or cannot be determined, e.g. if it concerns recovered heat from flue gases from product benchmark sub-installations. In such cases the entry field for the emission factor should be left empty.

††EF_{el}: will be applied automatically and does not need to be provided in the template.

8 ANNEX B – ABBREVIATIONS

ALC	Activity Level Change Implementing act
Adt	Air Dried Tonnes
AVR	Accreditation and Verification Regulation (Commission Implementing Regulation (EU) 2018/2067)
BFG	Blast Furnace Gas
BOFG	Blast Oxygen Furnace Gas
BM	Benchmark
BMU	Benchmark Update Implementing act
CA	Competent Authorities
CCS	Carbon Capture and Storage
CCU	Carbon Capture and Utilisation
CEMS	Continuous Emissions Monitoring Systems
CEN	European Committee for Standardization
CHP	Combined Heat and Power
CIMs	Transitional Community-wide and fully harmonised Implementing Measures pursuant to Article 10a(1) of the EU ETS Directive (Decision 2011/278/EU, applicable to 3 rd phase free allocation)
CLL	Carbon Leakage List, Commission Delegated Decision (EU) .../... of 15 February 2019 supplementing Directive 2003/87/EC of the European Parliament and of the Council concerning the determination of sectors and subsectors deemed at risk of carbon leakage for the period 2021 to 2030.
COG	Coke Oven Gas
CSCF	Cross Sectoral Correction Factor
CWT	CO ₂ weighted tonne
EC	European Commission
CLEF	Carbon leakage Exposure Factor
ETS	Emissions Trading System (in this Guidance Document it always refers to the EU ETS)
EU ETS	European Emissions Trading System, as established by Directive 2003/87/EC (the EU ETS Directive)
FAR	Free Allocation Rules, i.e. “transitional Union-wide rules for harmonised free allocation of emission allowances pursuant to Article 10a(1) of the EU ETS Directive”, Commission Delegated Regulation (EU) .../... of 19 December 2018.
GD	Guidance document

GDP	Gross Domestic Product
GHG	Greenhouse Gas
HAL	Historical Activity Level
IPPC	Integrated Pollution Prevention and Control
ISO	International Organization for Standardization
LRF	Linear Reduction Factor
MS	Member States
MRR	Monitoring and Reporting Regulation (Regulation (EU) 601/2012 applicable for the 3 rd phase; Commission Implementing Regulation (EU) 2018/2066 for the 4 th phase)
MRV	Monitoring, Reporting and Verification
MRVA	MRV, and Accreditation of verifiers; When referring to “MRVA Regulations”, both MRR and AVR are meant.
NCV	Net Calorific Value
NIMs	National Implementation Measures
NLMC	National Legal Metrological Control
RF	Reduction Factor
QA/QC	Quality Assurance / Quality Control
UCTE	Union for the Co-ordination of Transmission of Electricity
VCM	Vinyl Chloride Monomer