A Sustainable transformation of the Refrigeration and Air-conditioning sector

Possibilities of the RAC sector transformation – a technical perspective

The Delegation of the European Union in India and GIZ Proklima

7th November 2014, New Delhi, India

Dr Daniel Colbourne

Types of refrigerants

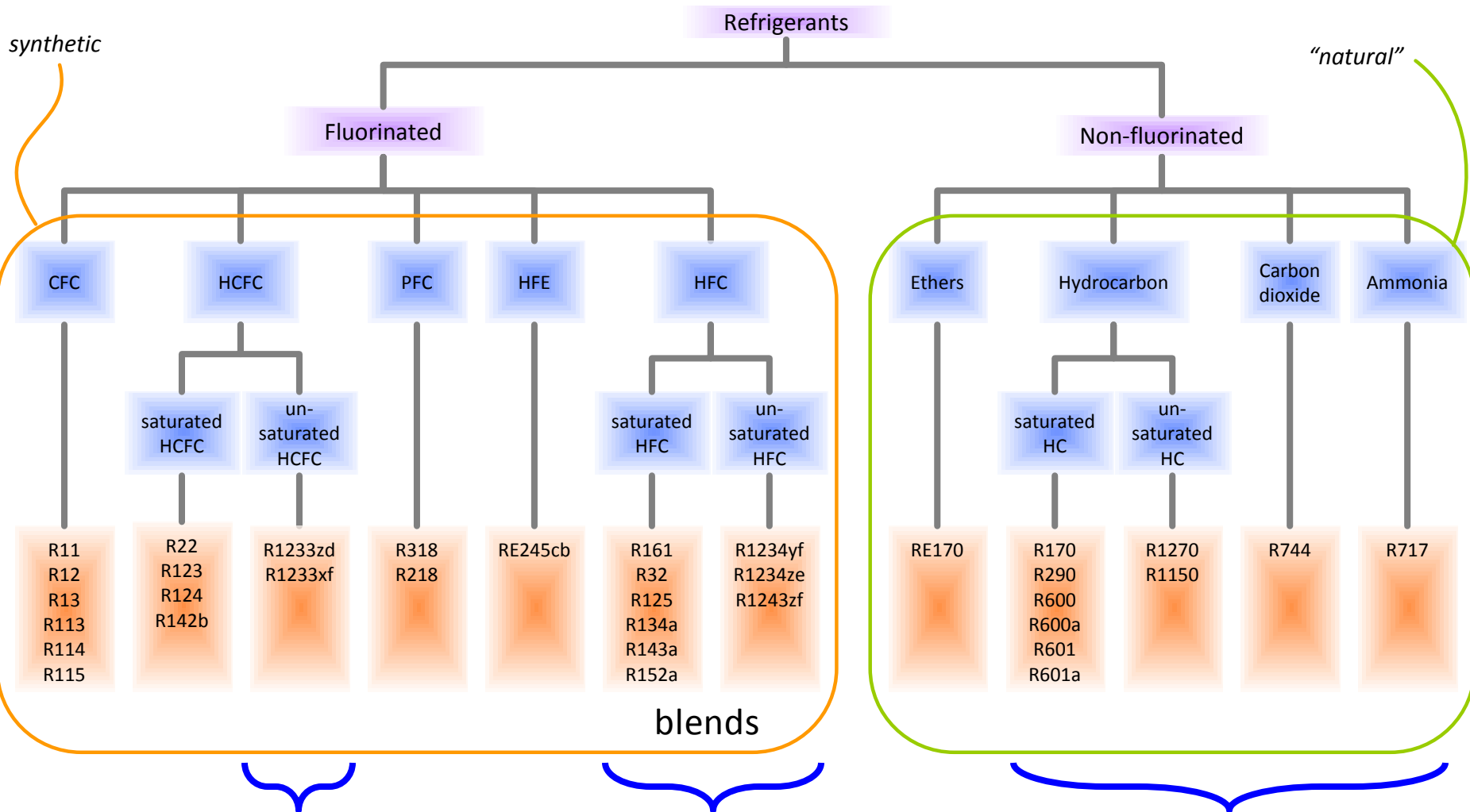

New medium (“lower”) GWP refrigerant mixtures

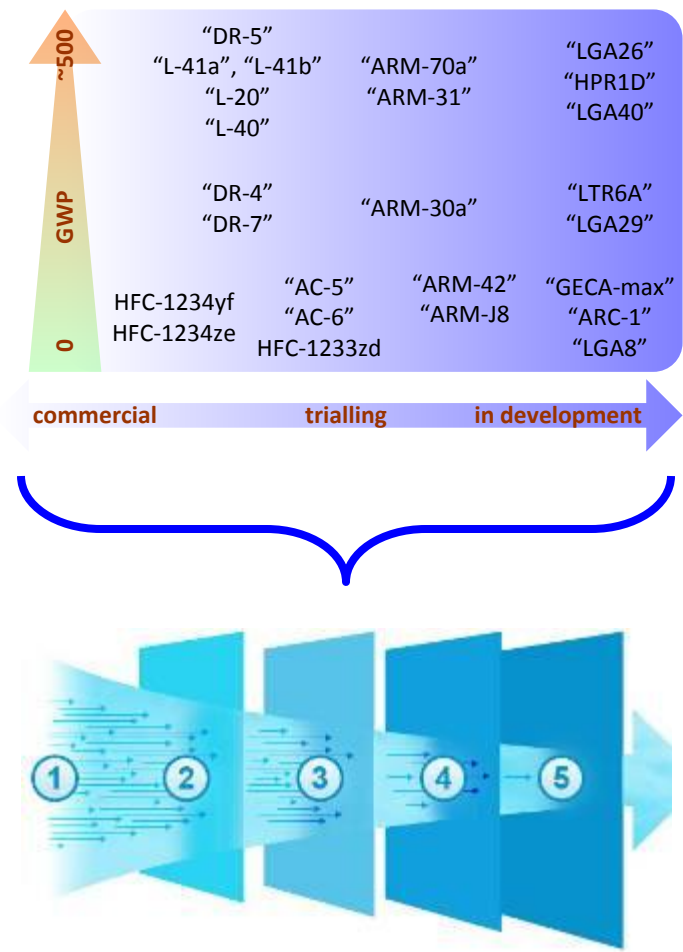
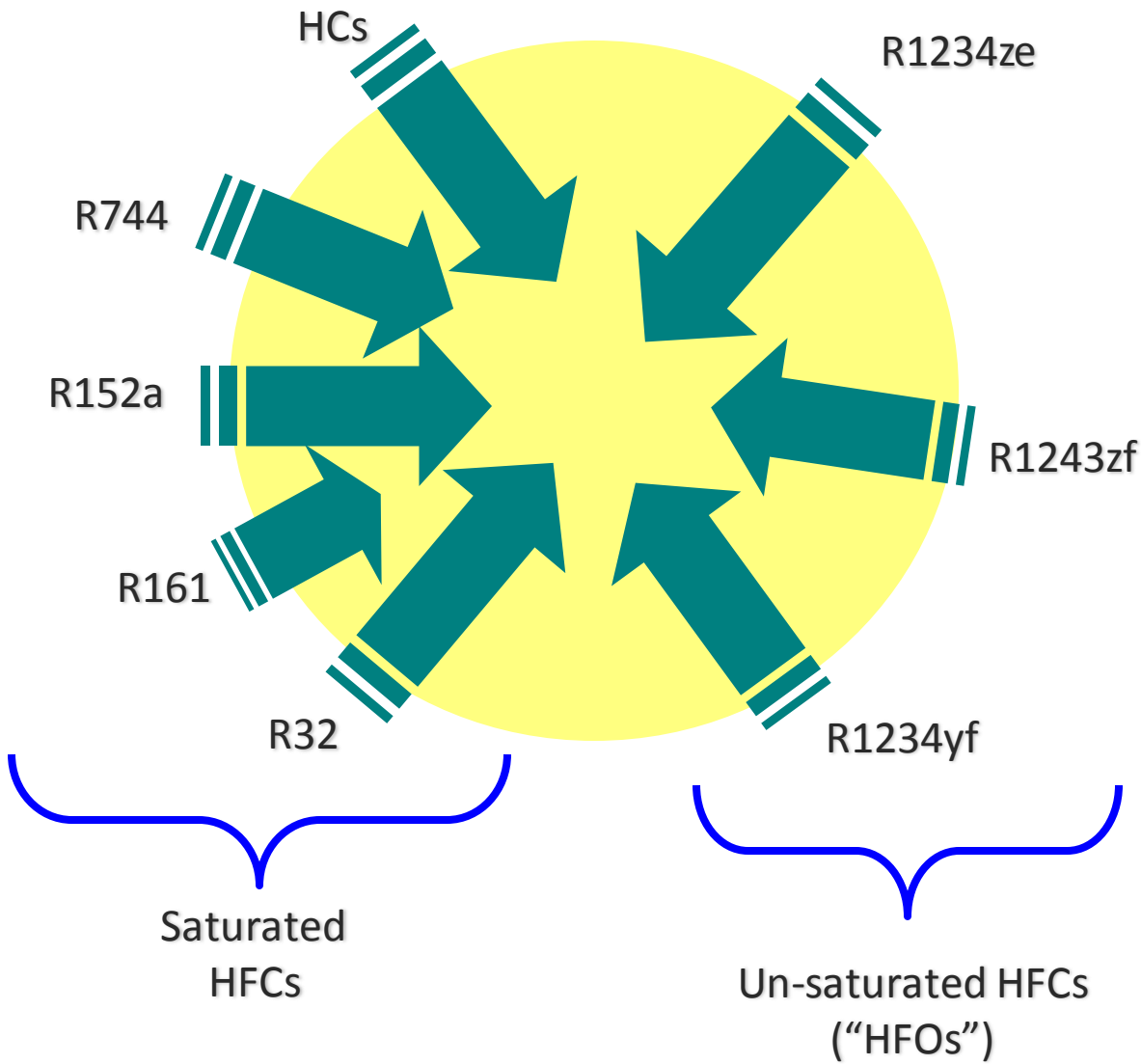

Overall global warming implications

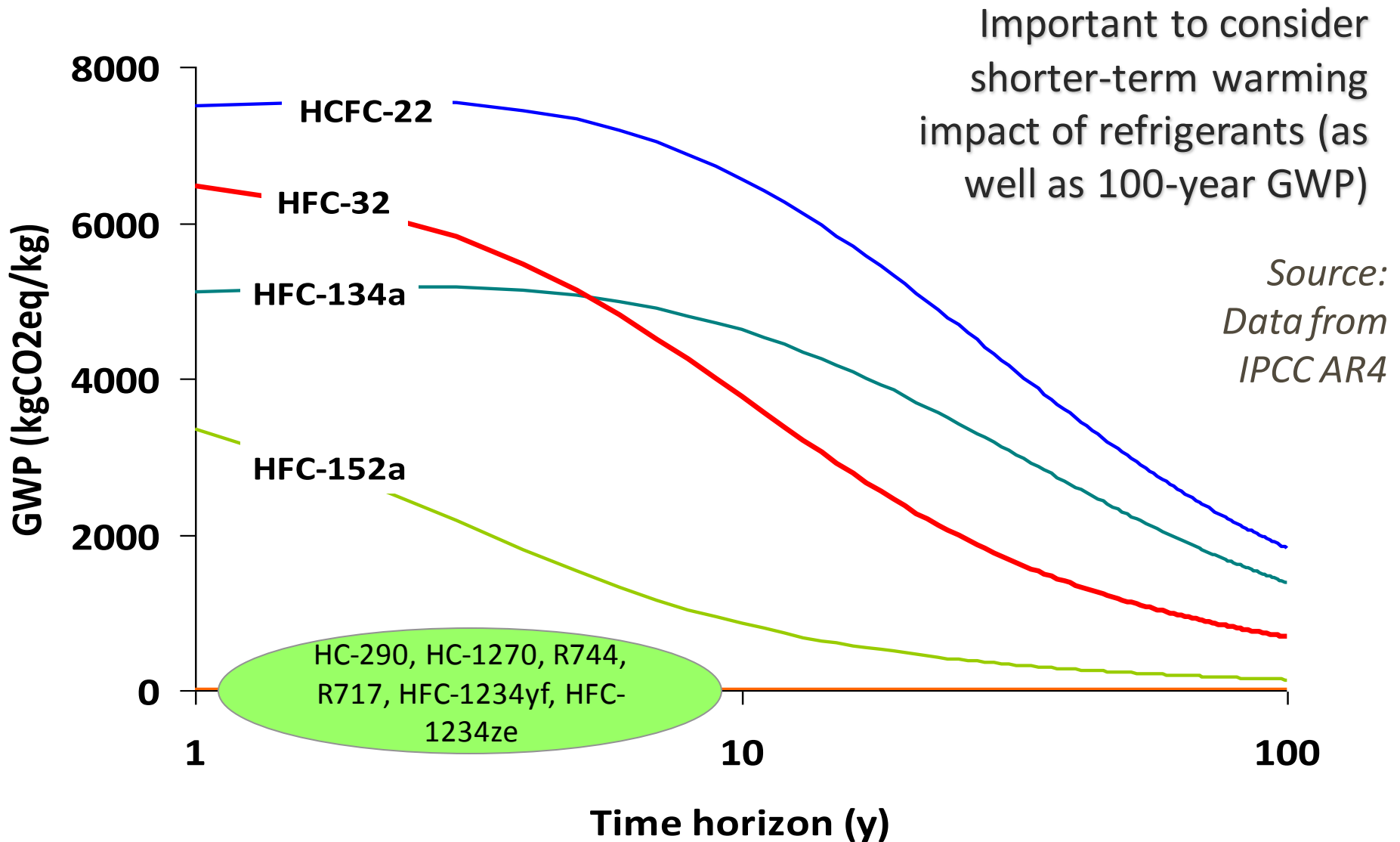

Ease of application of alternative refrigerants

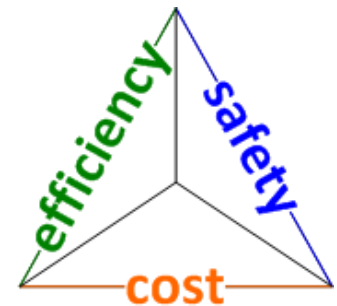
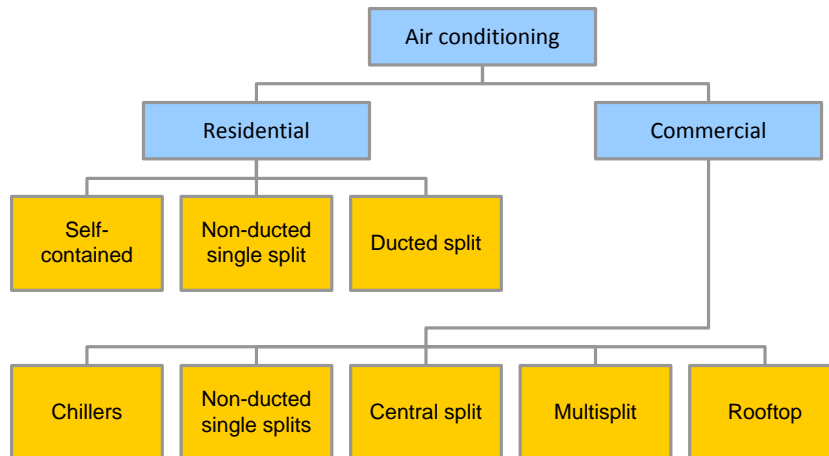
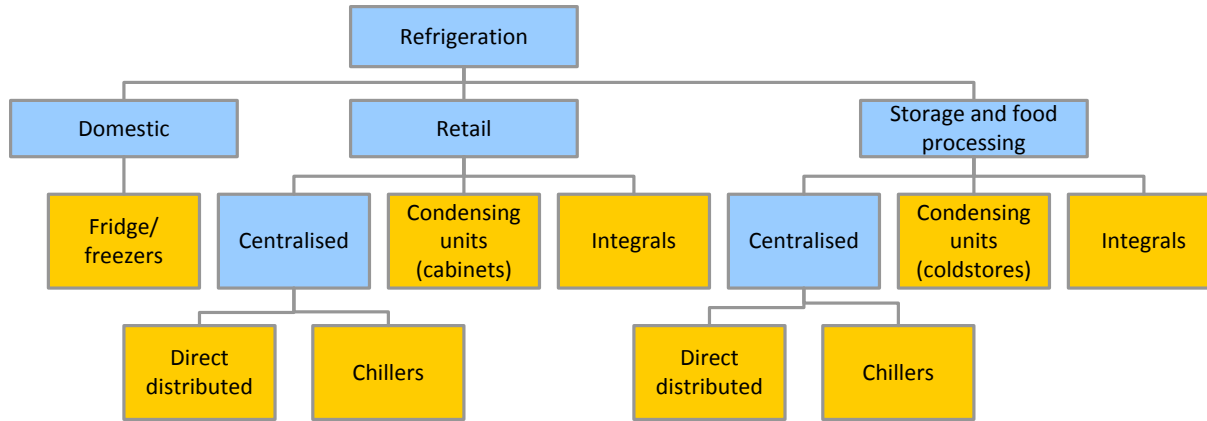

Critical to be wise to the IPR implications

- R-32
- R-290
- R-410A
- HFO-1234ze and yf
- HFO-1234ze or yf with R32 mixtures

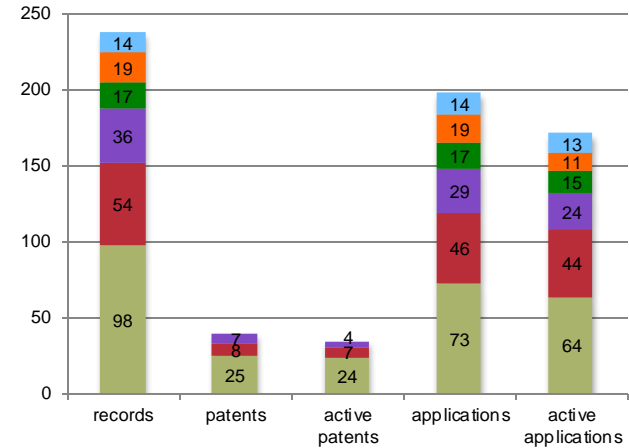
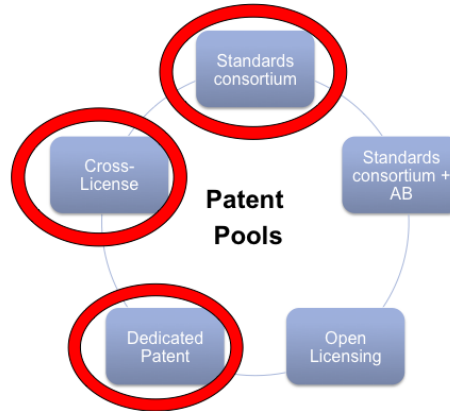
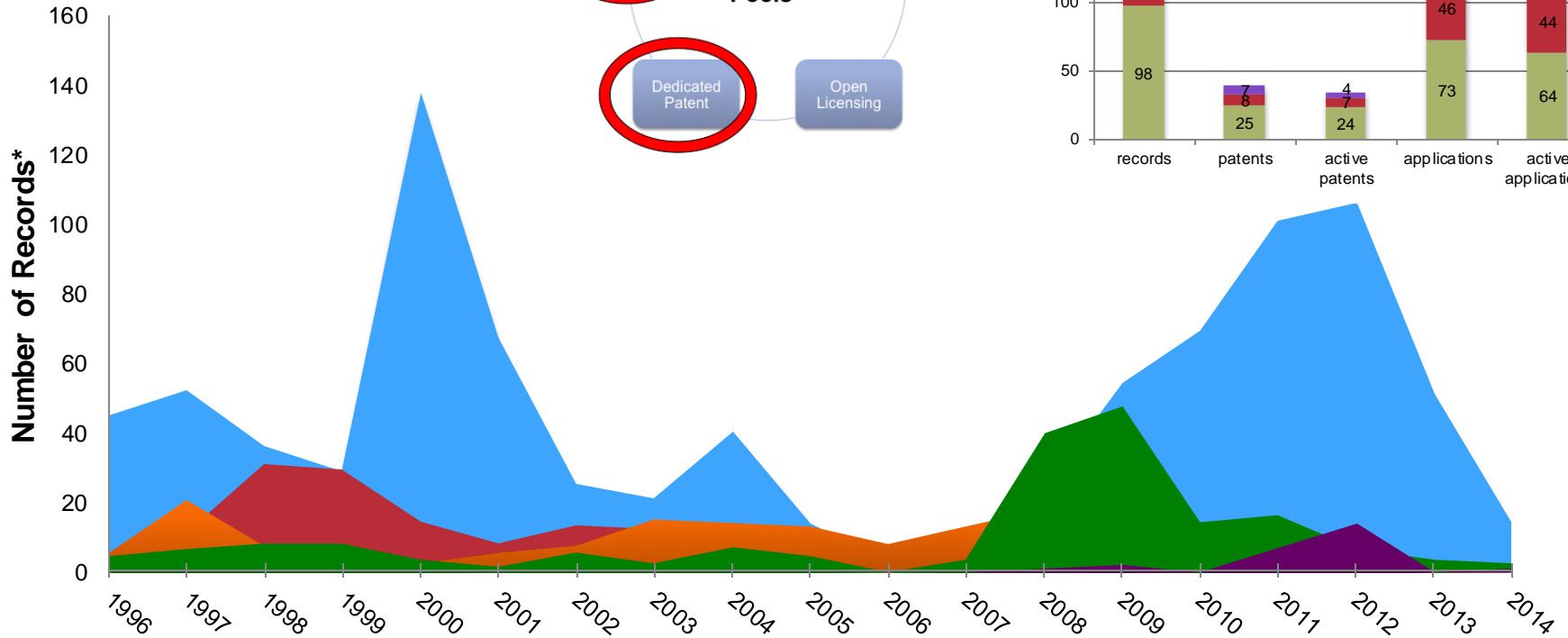

| | R-32 | R-290 | HFOs | R-410A | HFOs-R32 |
|---------------|------|-------|------|--------|----------|
| Total Records | 977 | 170 | 198 | 179 | 25 |

Domestic refrigeration

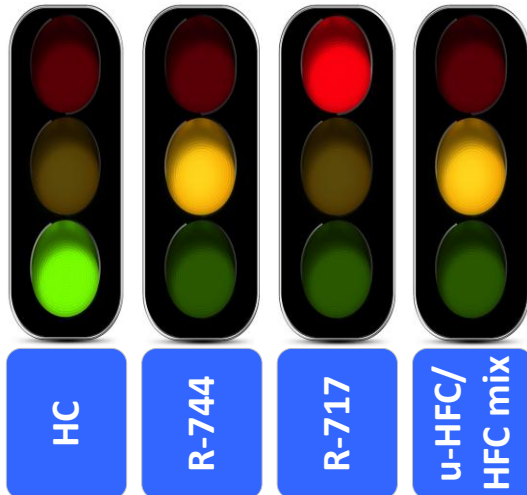
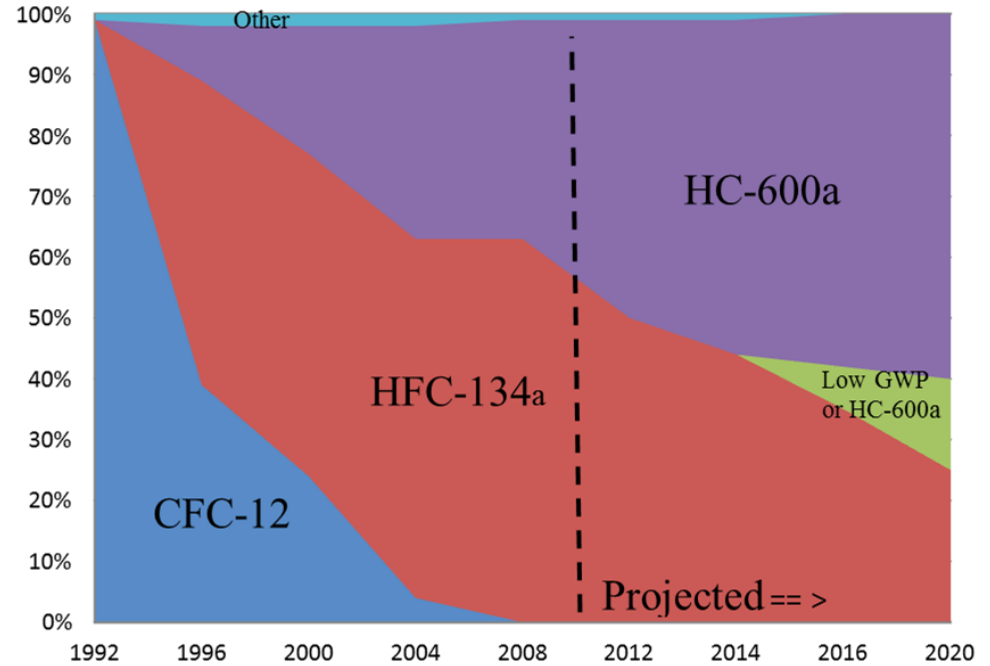

| COMPRES- SOR TYPE | REFRIG. | DISPLAC. [cc] | COOLING CAPACITY [W] | COP [W/W] |
|----------------------|---------|------------------|----------------------------|--------------|
| NBT1116Z | R134a | 7,4 | 143 | 1,17 |
| NBT1116Y | R600a | 12,3 | 145 | 1,25 |

Cecomaf conditions

Viabile application in small commercial refrigeration

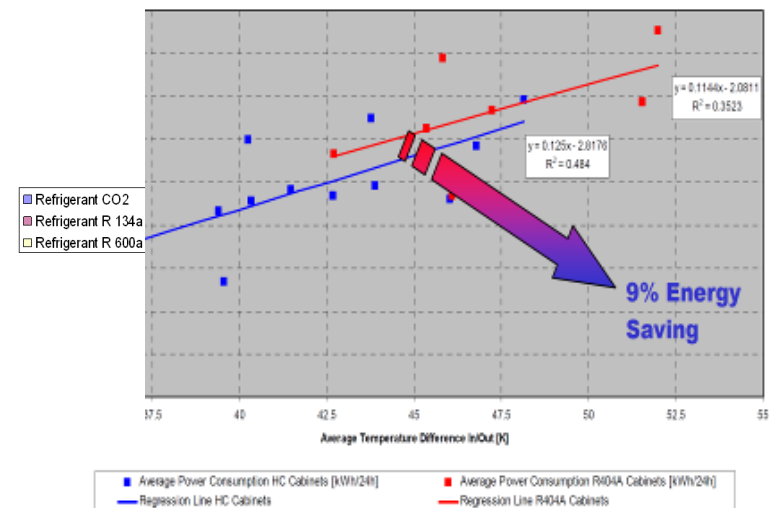
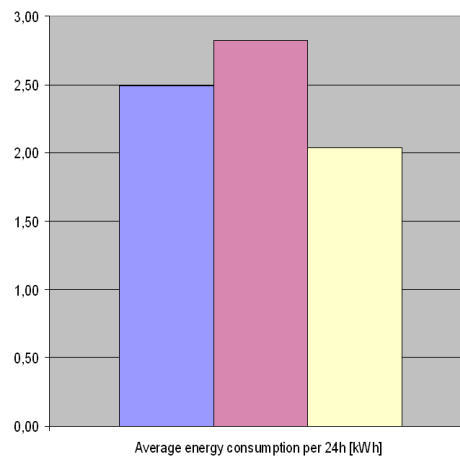
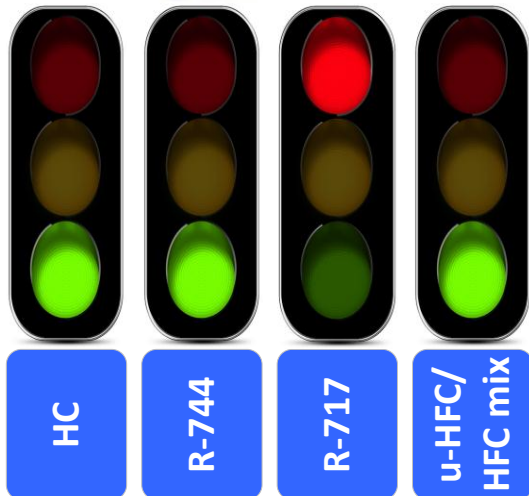

Medium size commercial refig /condensing units

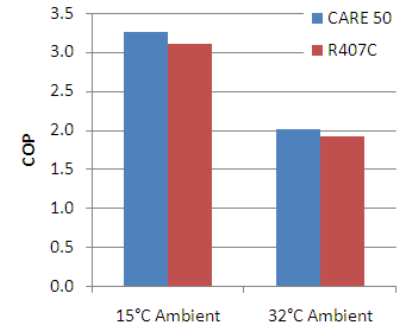
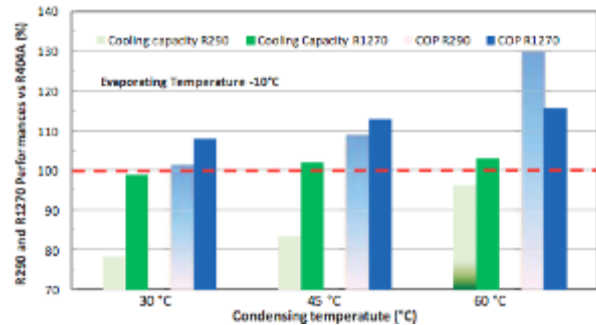
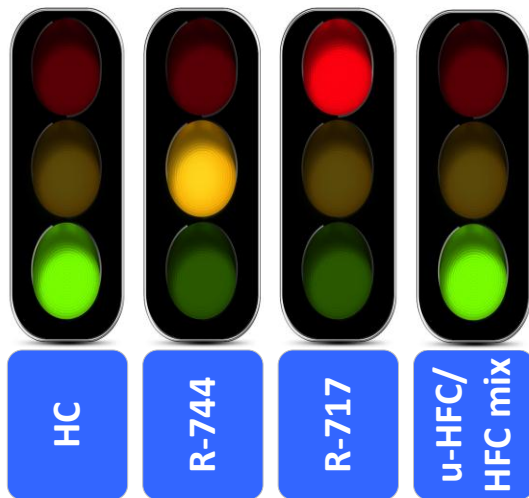

| R404a v R1270 Comparison Data | | | | | |
|-------------------------------|-------|--------|-------------------|-------------------|----------|
| Case Type | Model | Length | R404a DEC (watts) | R1270 DEC (watts) | % Saving |
| FHC | IC | 2.50m | 1424 | 1196 | -16% |
| HGD | GD | 2.50m | 1514 | 1272 | -16% |

Cold storage and food processing



eurammön
refrigerants delivered by mother nature

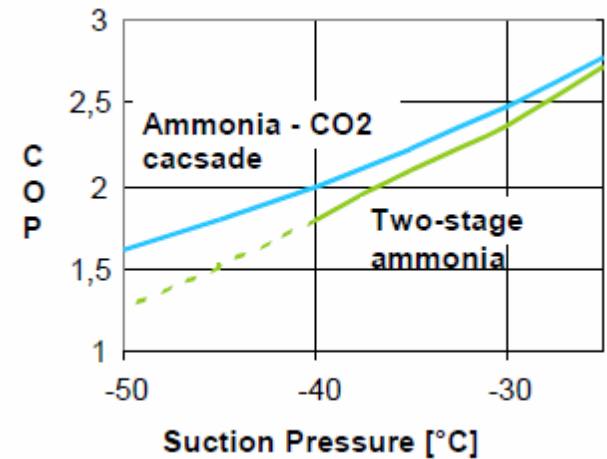
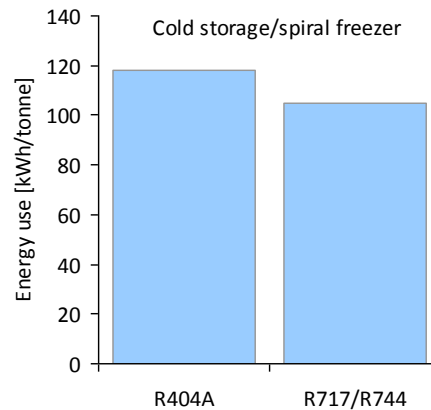
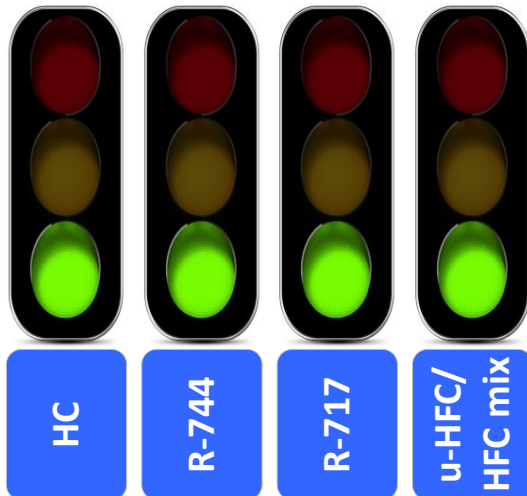

Self-contained air conditioners

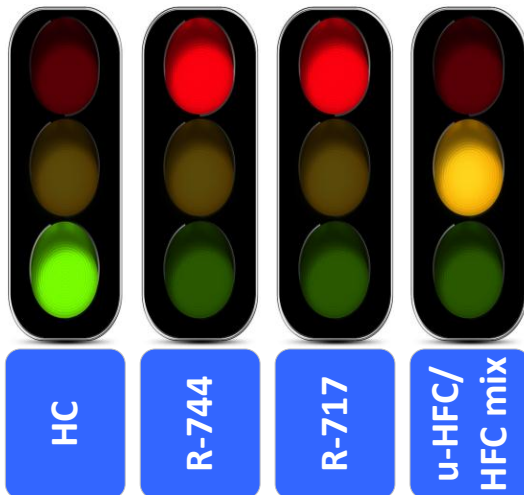
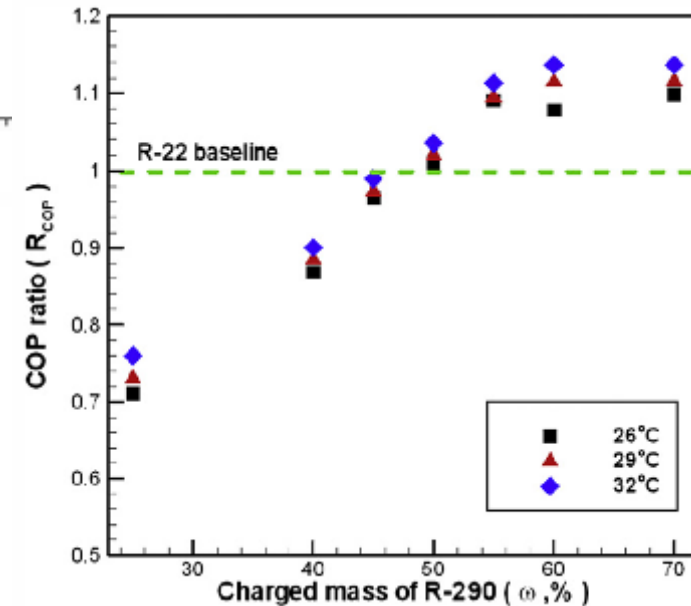
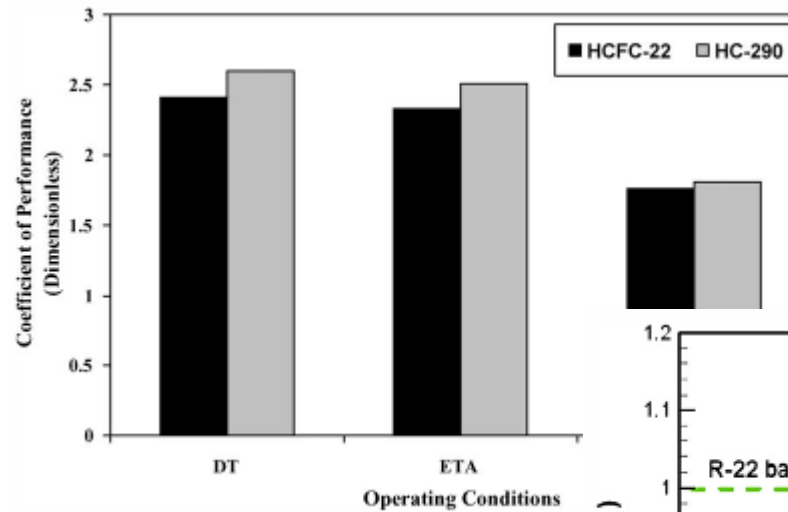

Single split air conditioners

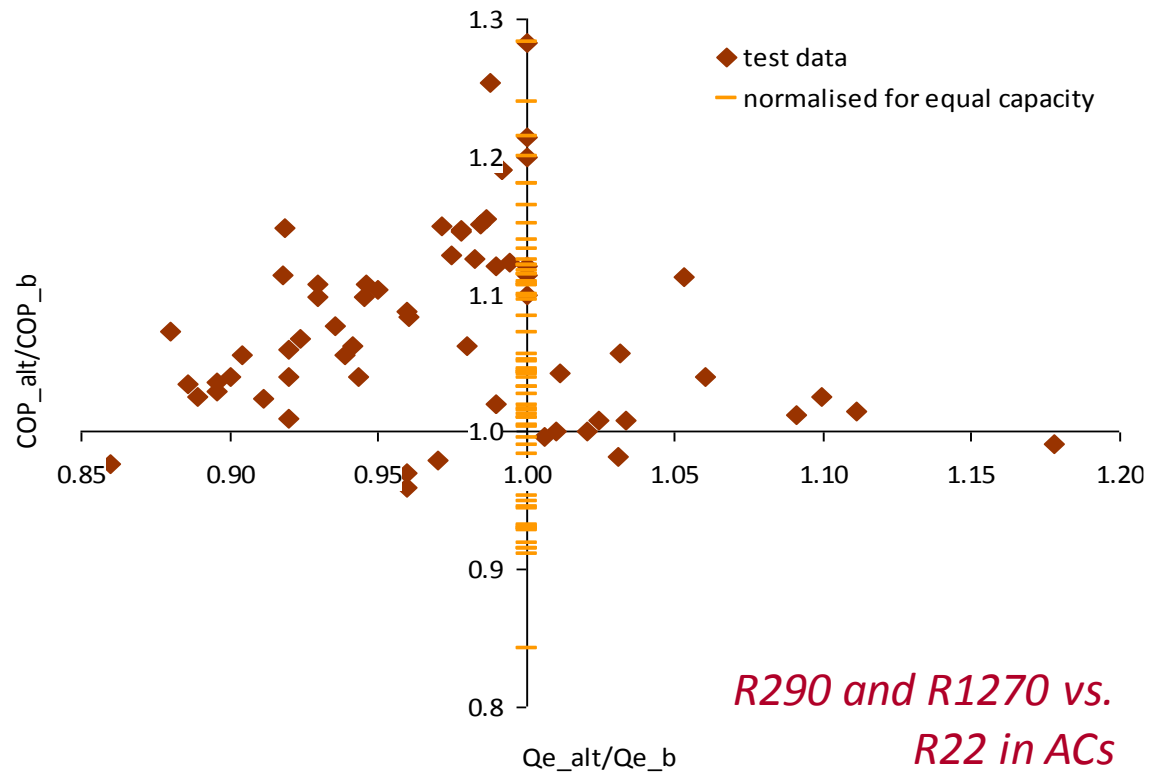
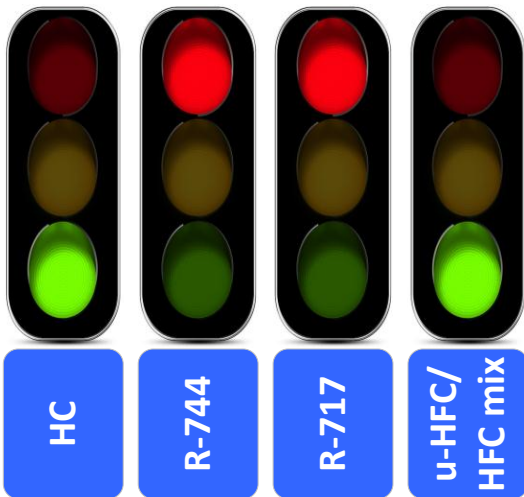

Ducted, central and multisplit systems



HC

R-744

R-717

u-HFC/
HFC mix

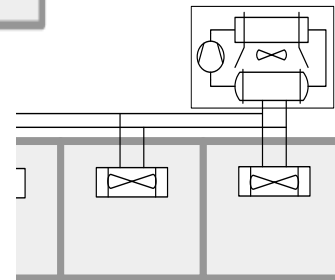
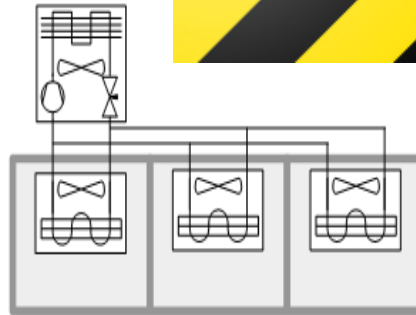

HC

R-744

R-717

u-HFC/
HFC mix

Chillers for air conditioning and refrigeration



GREEN & COOL

GEA

FRIGADON

arctic circle

STAR REFRIGERATION

TECNOFREDDO

ADVANSOR

Johnson Controls

FRIGOPOL

Bundgaard

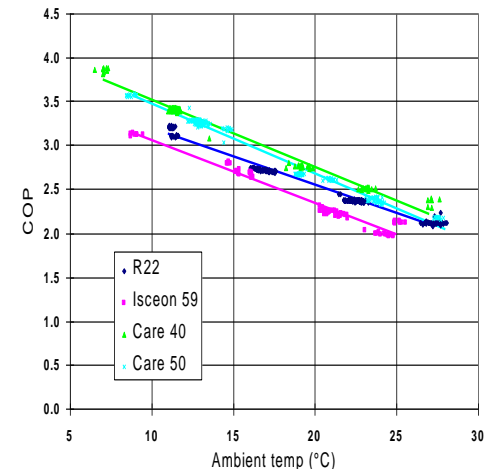
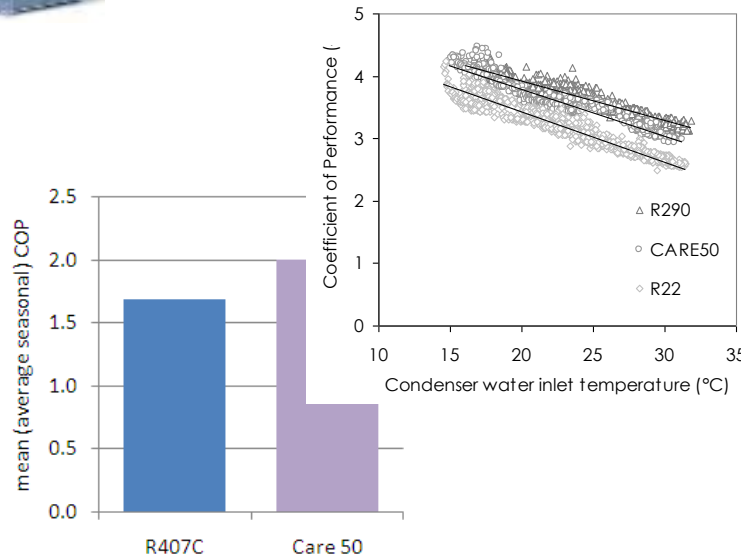
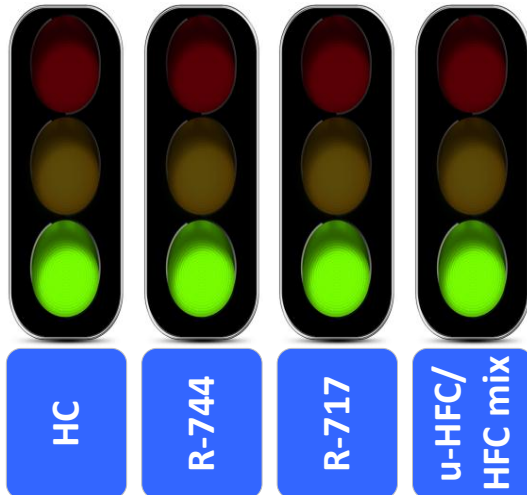

Important to understand the barriers

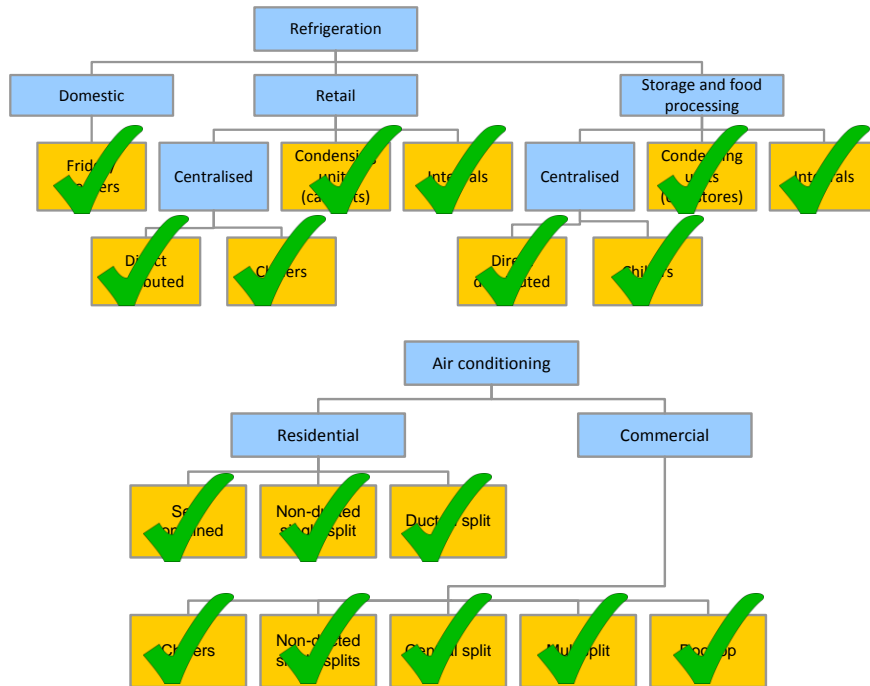

UNEP

EUROPEAN UNION

BARRIERS TO THE USE OF LOW-GWP REFRIGERANTS IN DEVELOPING COUNTRIES & OPPORTUNITIES TO OVERCOME THESE

UNITED NATIONS ENVIRONMENT PROGRAMME

Specific barriers and challenges

About 30 specific barriers identified...

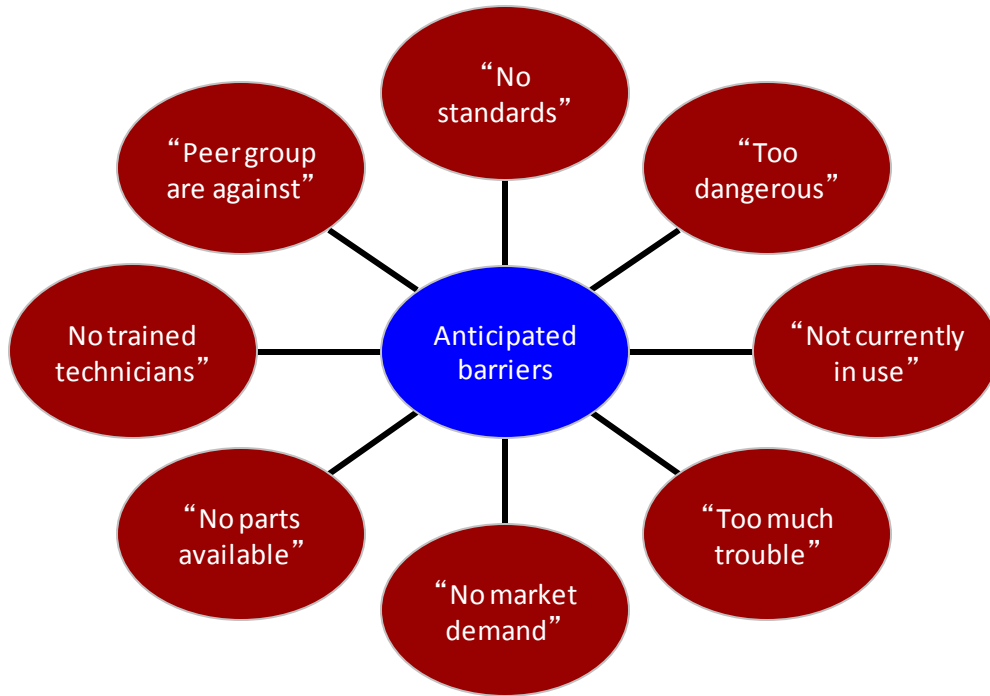

f^n

Country, region, size and type of equipment, type of refrigerant, perception of person making the statement, etc



VS.

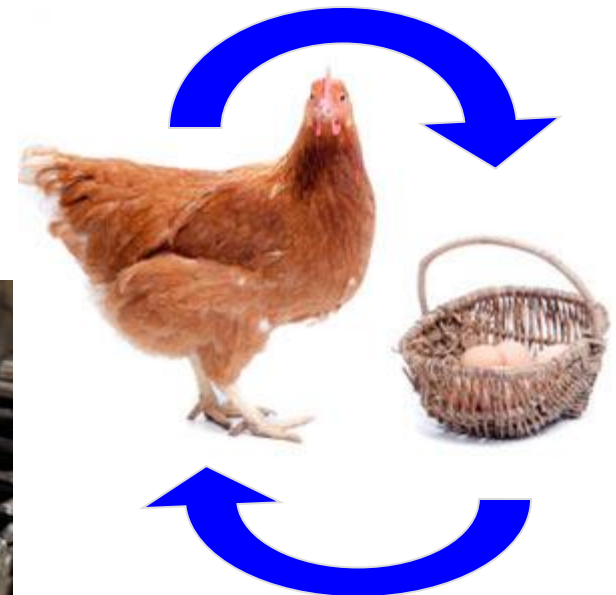

Encountering barriers

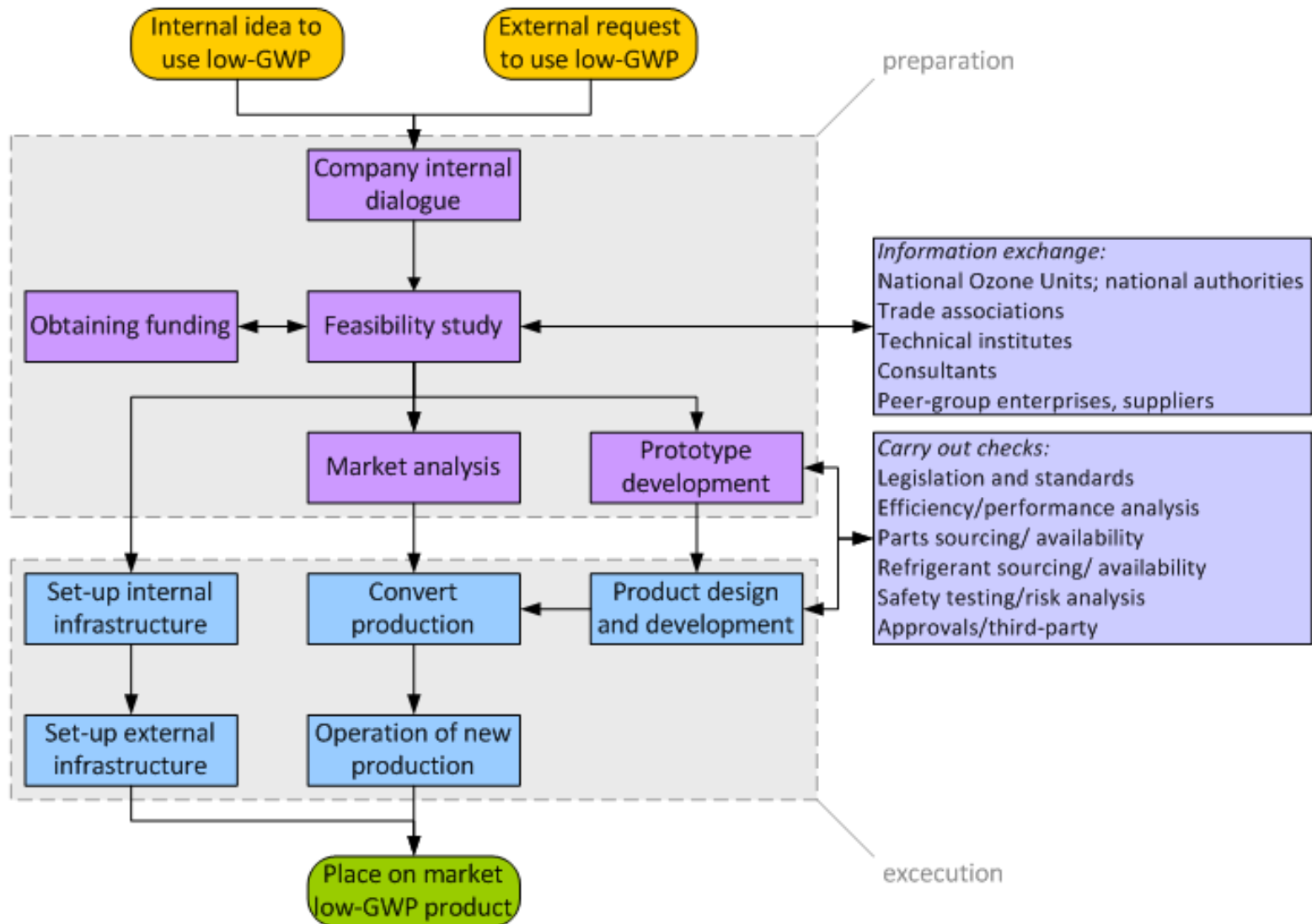

Overcoming barriers and challenges



Awareness-raising



Training

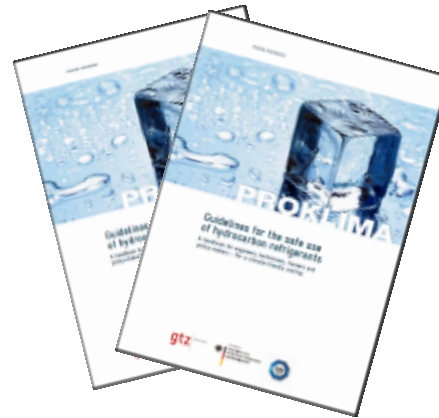

Guidance



Demo projects

Overcoming barriers and challenges

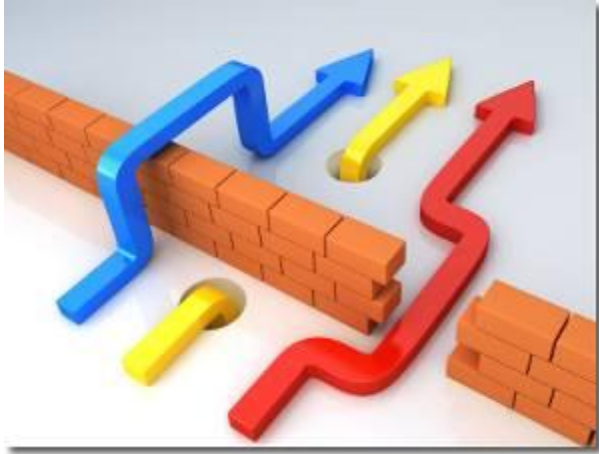

Market development...

stimulate industry involvement with low-GWP alternatives; encourage local manufacturing, product directories, etc



Financial

incentives...

subsidies for using low-GWP, tax incentives for low-GWP / tax disincentives for high-GWP



Regulatory infrastructure...

better control of industry to work safely, modify regulations that inhibit low-GWP alternatives, ensure safety standards are constructive

Overcoming barriers and challenges

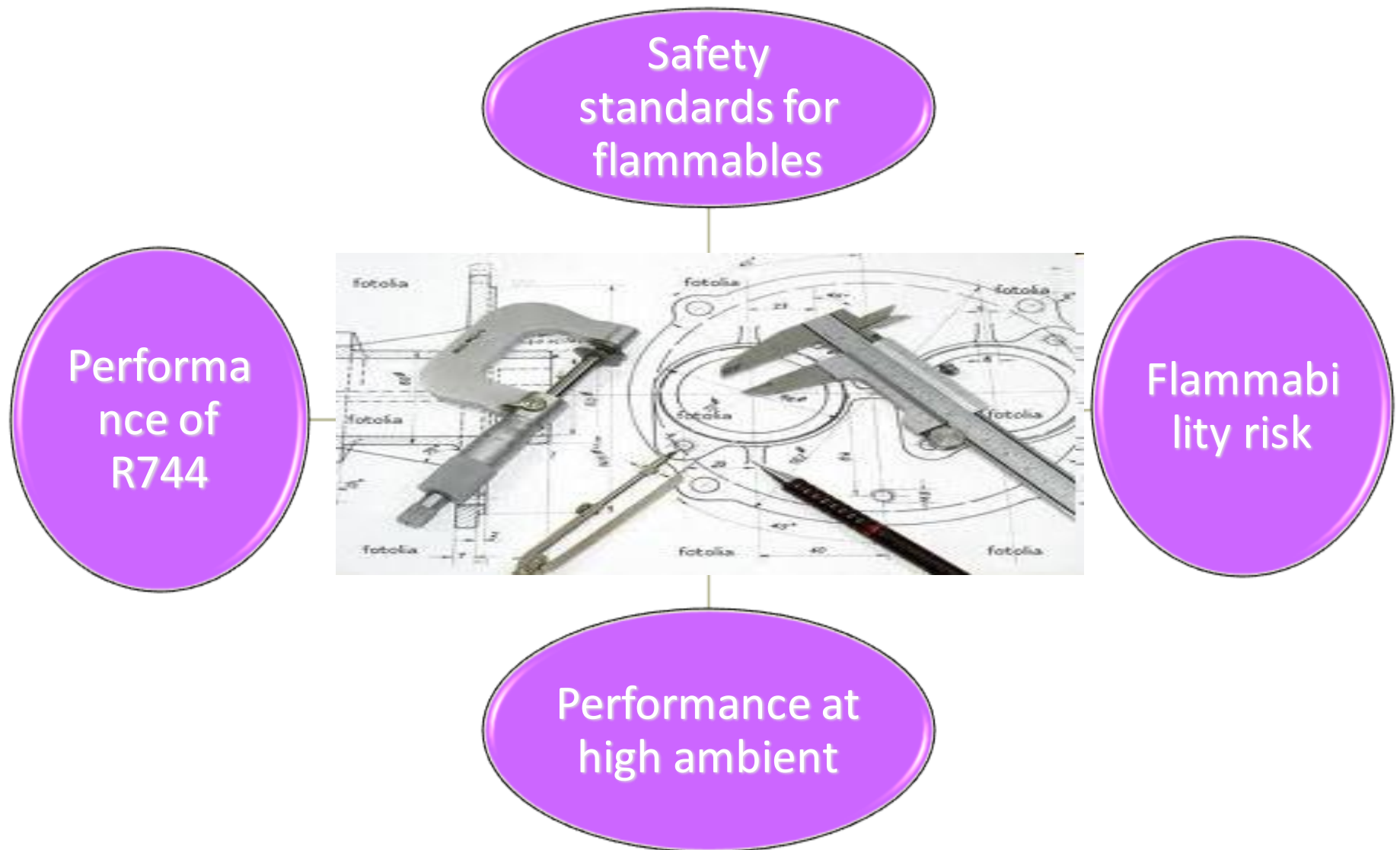

Performance of R744

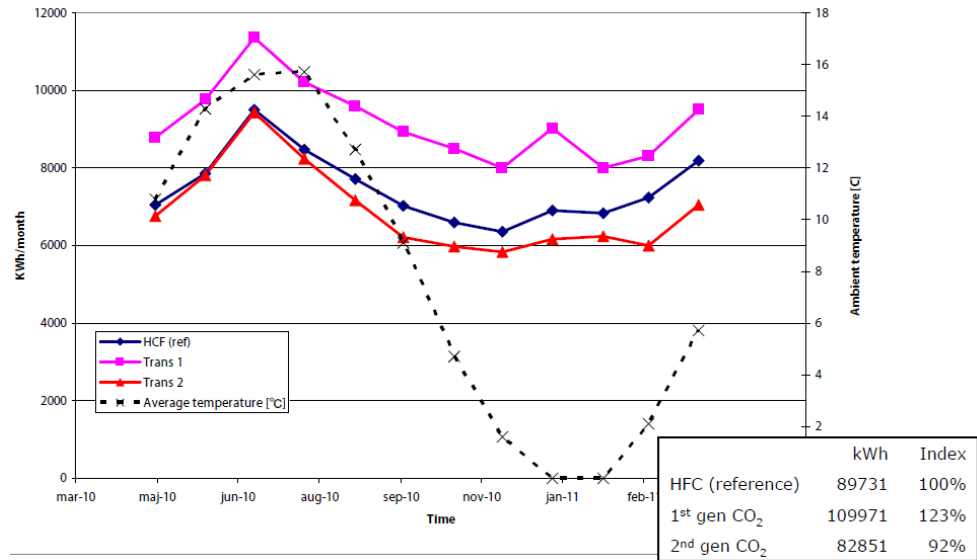
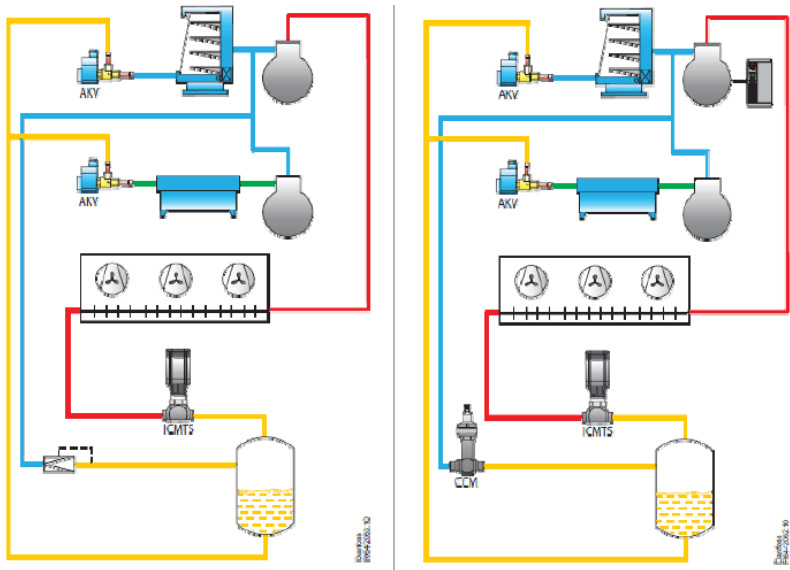
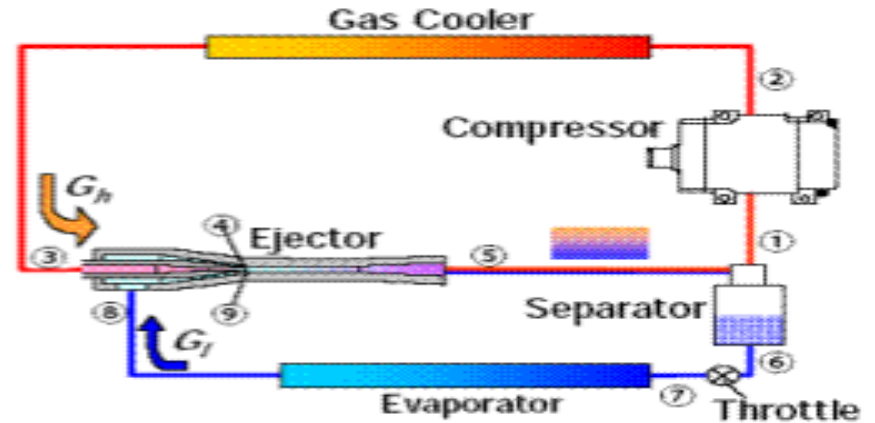
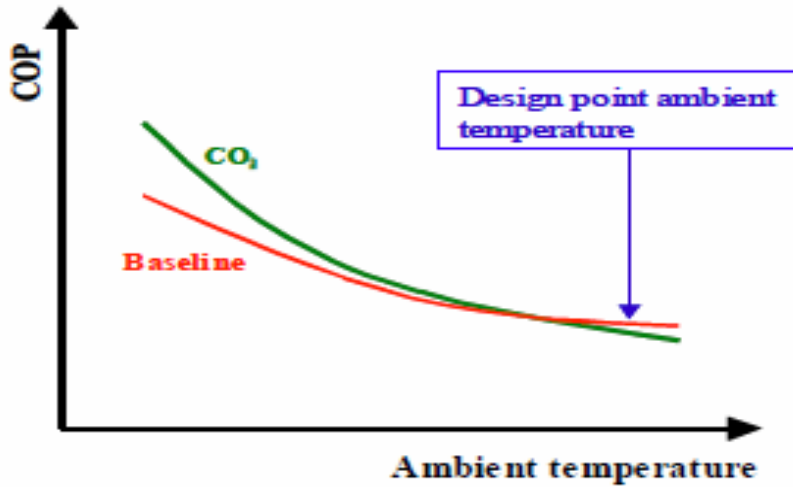

Performance at high ambient

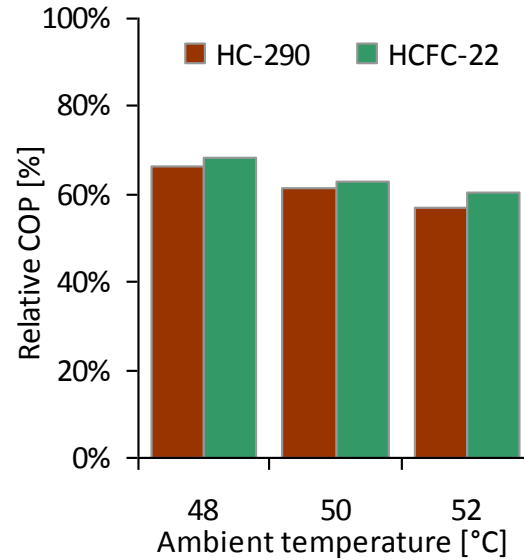
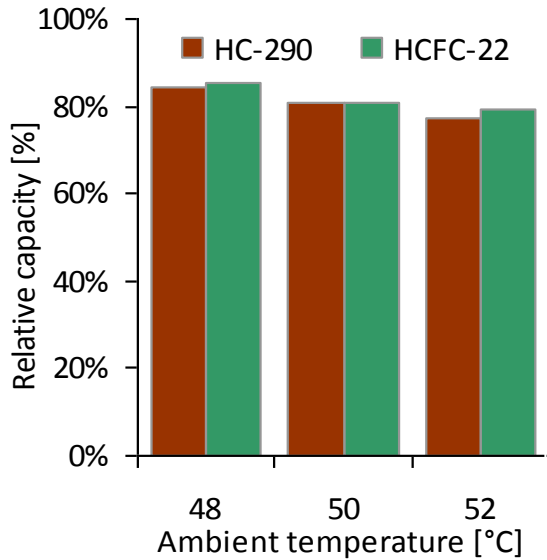

No performance degradation vs R22

Improved working conditions vs R22

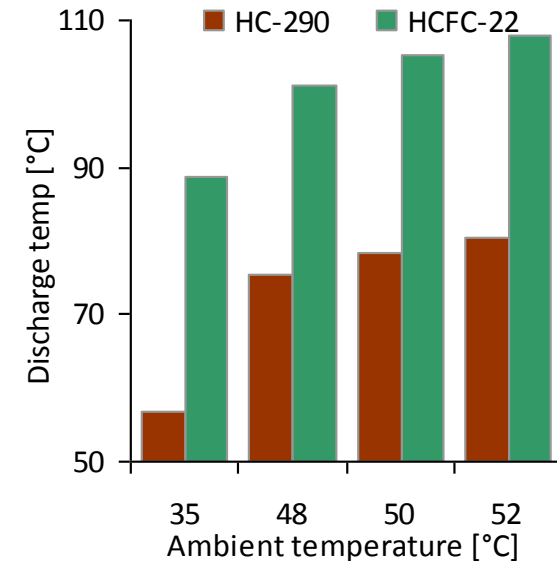
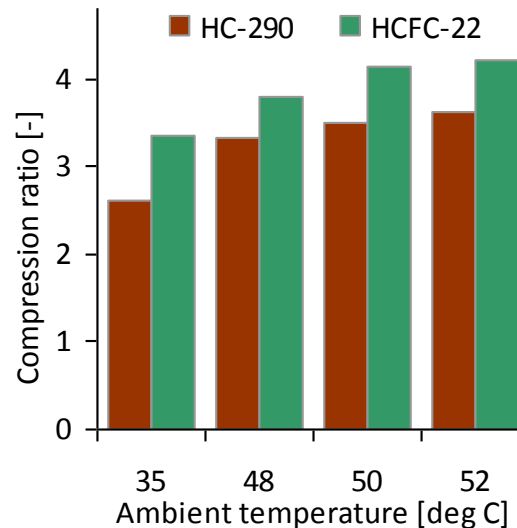

Safety rules for flammables

Refrigerant charge compared to value in obstructive AC standard

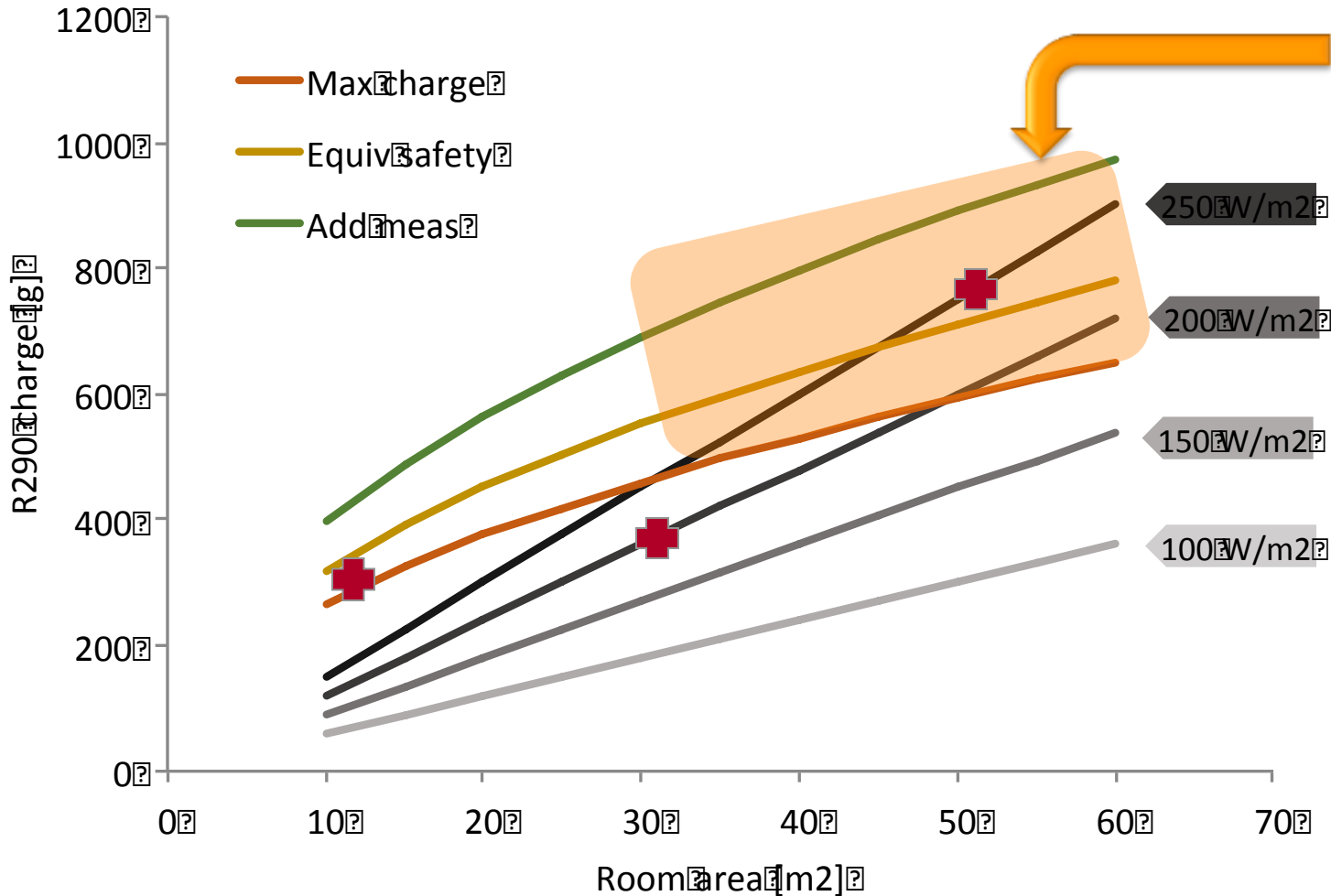

Higher capacities in larger spaces resolved through additional measures



✚ Cases in the risk assessment

Safety rules for flammables

Increase refrigerant charge (greater capacity)

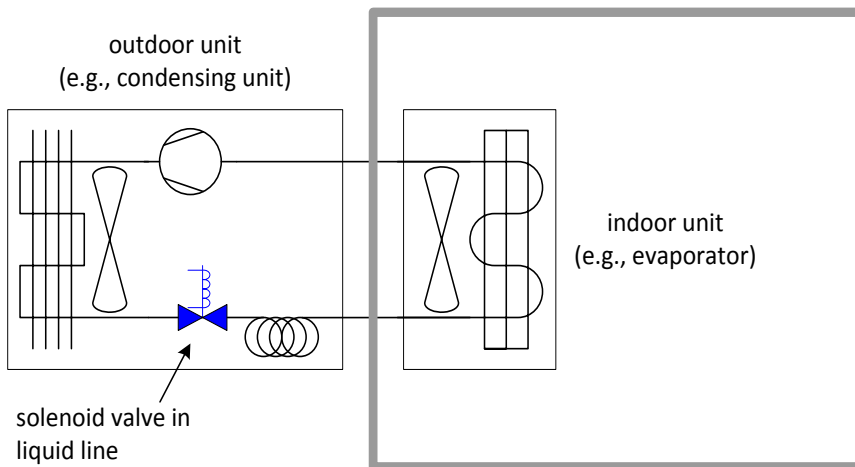
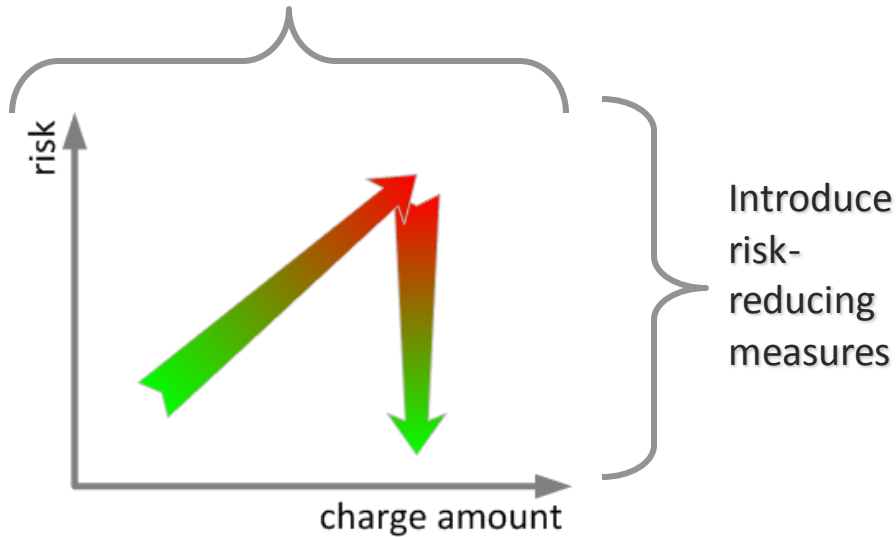

Safety rules for flammables

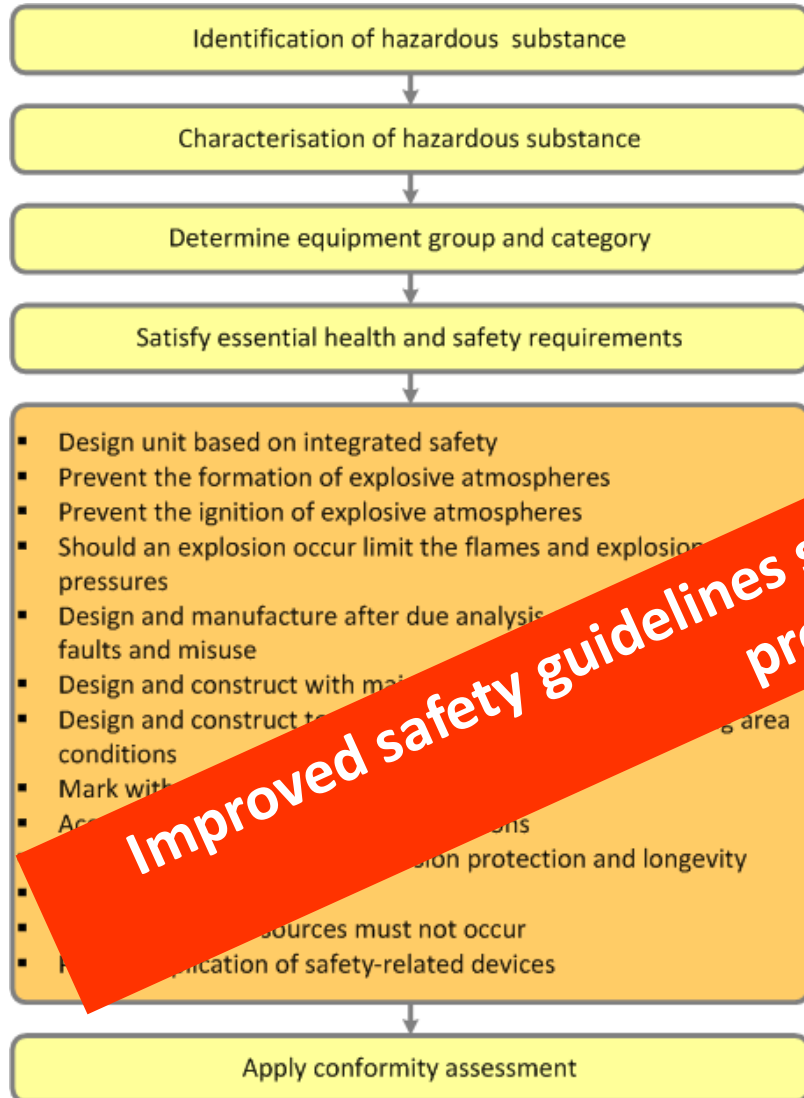

Requirements under Atex/EN 1127

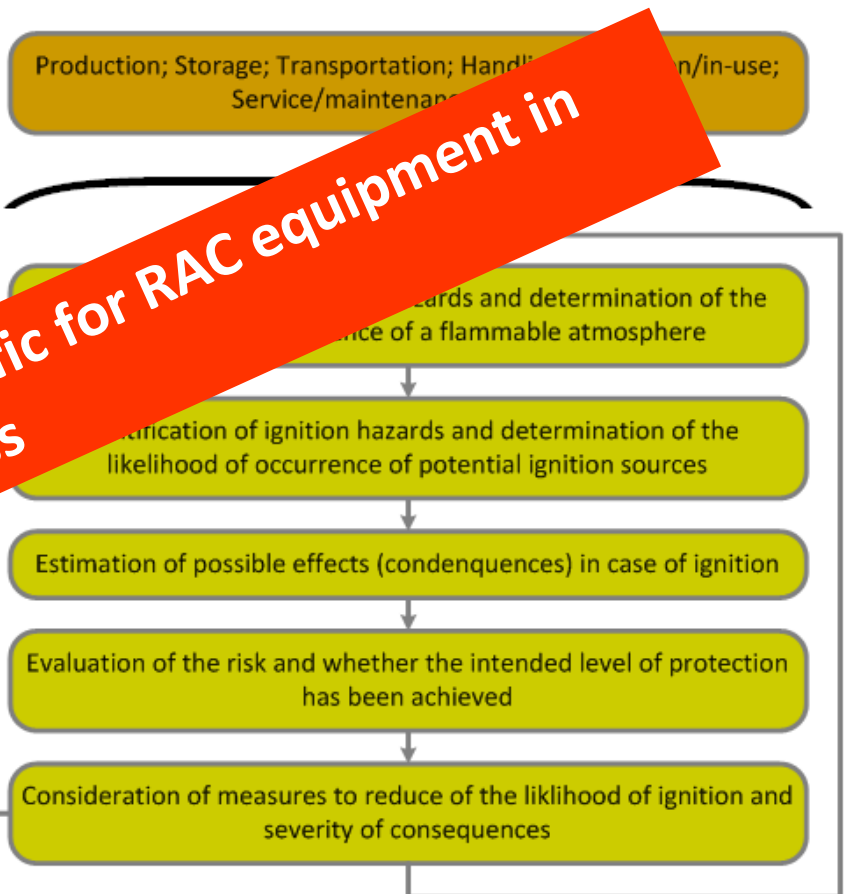

Improved safety guidelines specific for RAC equipment in progress

Flammability risk

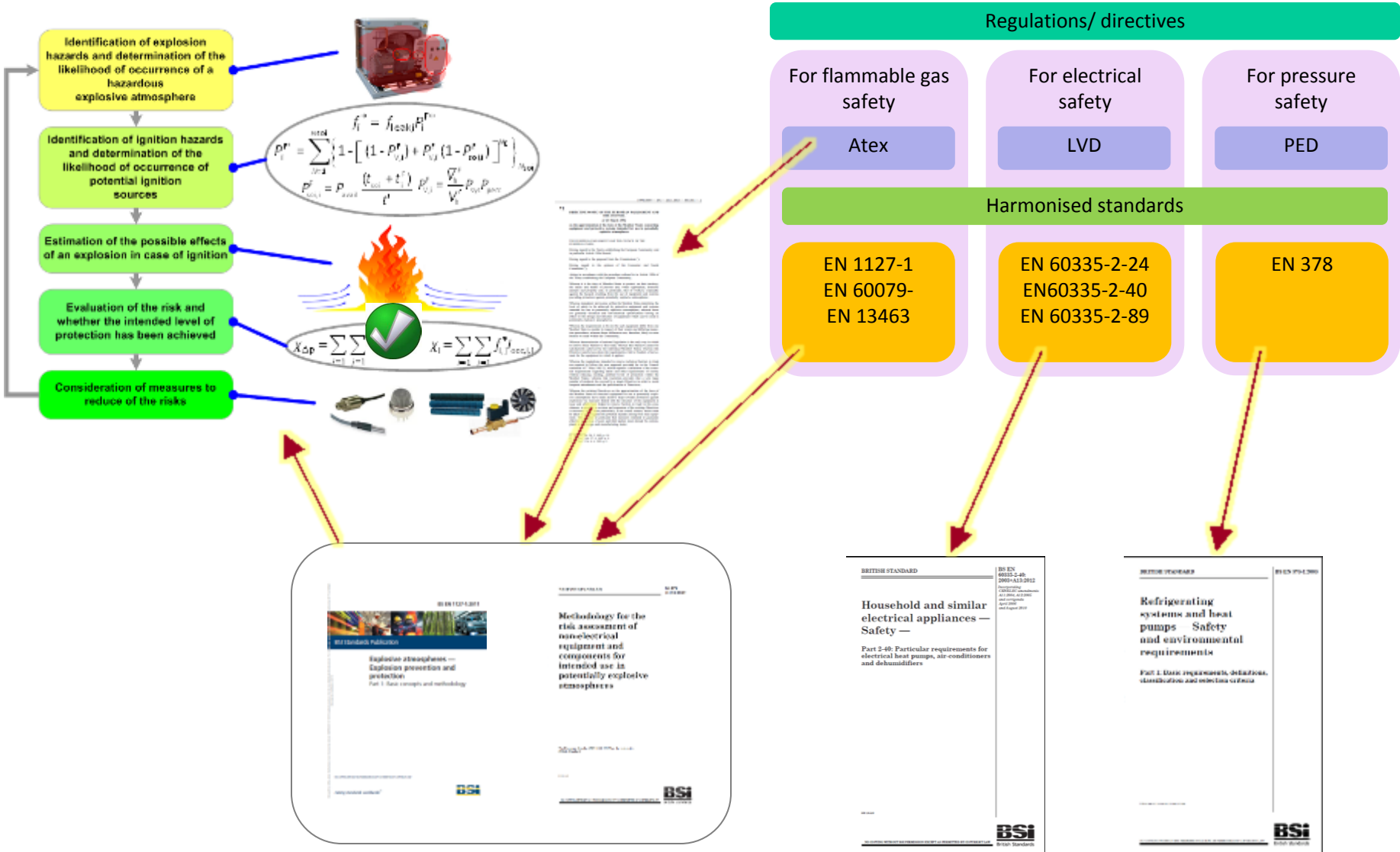

Flammability risk

Quantitative risk assessment for split ACs

| Risk measure | | 1TR | 1.5TR | 12 kW | |
|--------------------------|---------|----------------------|----------------------|----------------------|----|
| Ign | Model | 1TR | 1.5TR | 12 kW | 10 |
| Ign | Load | 350 W/m ² | 170 W/m ² | 240 W/m ² | 10 |
| Ign | Piping | 15 m | 15 m | 15 m | 17 |
| Ign | Charge | 0.35 kg | 0.42 kg | 0.75 kg | 13 |
| Ign | Room | 10 m ² | 30 m ² | 50 m ² | 10 |
| Ign | Persons | 2 | 6 | 10 | |
| Total ignition freq (/y) | | 8.0E-10 | 3.8E-9 | 1.3E-9 | |
| Freq secondary fire (/y) | | 8E-11 | 4E-10 | 2E-10 | |
| Max overpressure (kPa) | | 5.8 | 6.0 | 6.7 | |

Safety valve limits amount of gas that can leak into room

Risk of ignition is >10,000 times lower than background risk

Background fire frequency (USA) of ACs: $2 \times 10^{-5} \text{ y}^{-1}$

Can break windows only; requires an instant 3.0 mm leak hole in IDU!

Concluding remarks

- There are a variety of alternative refrigerants which have low or near-low GWP
- All sub-sectors can be satisfied with at least one of the alternatives
 - Unlike the past, there will be a mix of options
- Barriers and challenges do exist
 - Sometimes tangible hurdles; often due to lack of knowledge or misinformation
 - A number of approaches can be implemented to help overcome the barriers



**Thank you for
your attention**
