



EUROPEAN COMMISSION

DIRECTORATE-GENERAL

CLIMATE ACTION

**Directorate B - European & International Carbon Markets**

Guidance Document n°8  
on the harmonised free allocation methodology for the EU ETS  
post 2020

## **Waste gases and process emissions sub-installation**

*Final version issued on 14 February 2019*

The guidance does not represent an official position of the Commission and is not legally binding. However, this guidance aims to clarify the requirements established in the EU ETS Directive and the FAR and is essential to understanding those legally binding rules.

## Table of contents

1	Scope of this Guidance Document .....	1
2	Definitions.....	2
2.1	Articles relating to waste gases in the FAR and in the Directive .....	2
2.2	Definition of waste gases.....	2
3	Background to waste gases in specific industries .....	9
3.1	Iron and Steel and other metals industry .....	9
3.2	Chemical industry .....	9
4	Calculation of Activity Levels and allocation .....	11
4.1	Allocation relating to the production of the waste gas.....	12
4.2	Allocation relating to the consumption of the waste gas .....	15
4.3	Total allocation for production and consumption of waste gases .....	16
4.4	Summary of allocation methodologies in the case of waste gases.....	19
5	Case Studies.....	21
5.1	Example 1 – defining sub-installations linked to waste gases.....	21
5.2	Example 2 – allocation in the case of a benchmarked product.....	29
5.3	Example 3 – allocation in the case of a non-benchmarked product .....	30
	Annex A: Comparison with 2011 Guidance Document 8 .....	33

# 1 Scope of this Guidance Document

This guidance document is part of a group of documents, which are intended to support the Member States, and their Competent Authorities, in the consistent implementation throughout the Union of the allocation methodology for the fourth trading period of the EU ETS (post 2020), established by the Delegated Regulation of the Commission XX/XX on “Transitional Union-wide rules for harmonised free allocation of emission allowances pursuant to Article 10a of the EU ETS Directive” (FAR). Guidance Document 1 on General Guidance to the Allocation Methodology provides an overview of the legislative background to the group of guidance documents. It also explains how the different Guidance Documents relate to each other and provides a glossary of important terminology used throughout the guidance.<sup>1</sup>

The current Guidance Document provides guidance to Competent Authorities (CA) on how to allocate free allowances to installations which produce and consume waste gases and more generally on the allocation according to the process emissions sub-installation.

Chapter 2 of this document presents the definitions of waste gases and the process emissions sub-installation. Subsequently, Chapter 3 provides some background on the occurrence of waste gases in industry. Chapter 4 discusses allocation in case of production and consumption of waste gases. Chapter 5 illustrates these rules with a few case studies. An overview of the main changes in this guidance document compared to the 2011 version developed for Phase 3 is included in Annex A.

*Note that this Guidance Document does not provide details on how to attribute emissions to sub-installations. For more details on this topic, see Guidance Document 5 on Monitoring & Reporting for the FAR.*

References to articles within this document generally refer to the revised EU ETS Directive and to the FAR.

## **Note on outstanding issues in this version of the Guidance Document**

As decision-making on the allocation methodology is not yet finalized, certain elements of this Guidance Document are as yet undefined. This especially includes issues related to the implementing act still to be adopted on the detailed rules on the changes to allocations of free allowances, the update of the benchmark values and the new carbon leakage list. In addition, it can also apply to references to the outstanding legislation itself or to accompanying Guidance Documents that are still to be prepared or finalized.

---

<sup>1</sup> All Guidance Documents can be found at: [https://ec.europa.eu/clima/policies/ets/allowances\\_en#tab-0-1](https://ec.europa.eu/clima/policies/ets/allowances_en#tab-0-1)

## 2 Definitions

### 2.1 Articles relating to waste gases in the FAR and in the Directive

Definitions and allocation rules in this Guidance Document are based on the FAR. Relevant articles are:

- The definitions in:
  - Art. 2(10) on process emissions sub-installation (as well as all other articles relevant for process emissions);
  - Art. 2(11) on waste gas;
  - Art. 2(13) on safety flaring.
- Art.10(5) on the correct division of an installation into sub-installations;
- Art.16(5) on aspects relating to the flaring of waste gases.

Annexes of the FAR also include content relating to waste gases, in particular:

- Annex IV relating to the parameters for baseline data collection;
- Annex VI relating to the minimum content of the monitoring methodology plan;
- Annex VII relating to the applicable monitoring methods.

Finally, the following articles of the EU ETS Directive relate to waste gases:

- Art. 3(t), in the definition of 'combustion';
- Art. 10a(1), in the listed incentives for reductions in greenhouse gas emissions and energy efficient techniques;
- Art. 10a(2), in relation to the hot metal benchmark.

### 2.2 Definition of waste gases

The definition of a **waste gas** in Art.2(11) of the FAR states that:

*'waste gas' means a gas containing incompletely oxidised carbon in a gaseous state under standard conditions which is a result of any of the processes listed in point (10), where 'standard conditions' means temperature of 273,15 K and pressure conditions of 101 325 Pa defining normal cubic meters (Nm<sup>3</sup>) according to Article 3(50) of Commission Regulation (EU) No 601/2012*

To be considered a waste gas, a gas must therefore satisfy all of the following three conditions:

1. Contain incompletely oxidised carbon;
2. Be in a gaseous state under standard conditions;
3. Occur as a result of one of the processes listed in the definition of process emissions.

**Meeting condition 1: contain incompletely oxidised carbon**

Carbon reacts with oxygen according to the following chemical equations:

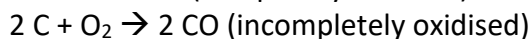
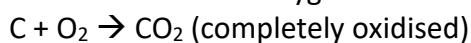

Incompletely oxidised carbon may also consist of partially oxidised organic products according to the following (simplified) reaction:

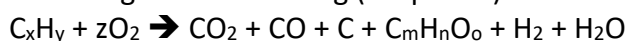

Waste gases are usually a mix of different gases including CO<sub>2</sub> which are transferred from the originating process to other processes. Within these mixes, the CO<sub>2</sub> content is treated as part of the waste gas stream. The higher the share of non- and incompletely oxidized carbon in fuels, the higher the calorific value. The calorific value of completely oxidised carbon (CO<sub>2</sub>) is zero.

Incompletely oxidised carbon will be in the form of CO or C<sub>m</sub>H<sub>n</sub>O<sub>o</sub>. The amount of incompletely oxidised carbon should be higher than 1 weight percent in the gas on average. Therefore, a pure hydrocarbon gas, with less than 1 weight percent oxygen bounded compounds (e.g. 99% ethylene), would not be considered a waste gas. Furthermore, a pure CO<sub>2</sub> stream of 99% purity (i.e. completely oxidised) cannot be considered a waste gas.

**Meeting condition 2: Be in a gaseous state under standard conditions**

This means that the waste gas must be in a gaseous state under standard conditions. This does not exclude that fractions of the organic material in the waste gas might condense under these conditions. The sum of the fractions should on average not exceed 10 weight percent of the total gas. However, if any part of the waste gas is condensated and separated from the waste gas, this part ceases to be considered (part of) a waste gas.

**Meeting condition 3: Occur as a result of one of the processes listed in the definition of process emissions**

In order to assess whether condition 3 is met, the following background information should help to clarify and distinguish between process emissions and allocation for waste gases as part of the process emissions sub-installation.

The **process emissions sub-installation** is defined in Art.2(10) of the FAR:

*'Process emissions sub-installation' means greenhouse gas emissions listed in Annex I to Directive 2003/87/EC other than carbon dioxide, which occur outside the system boundaries of a product benchmark listed in Annex I to this Regulation, or carbon dioxide emissions, which occur outside the system boundaries of a product benchmark*

*listed in Annex I to this Regulation, as a direct and immediate result of any of the following processes and emissions stemming from the combustion of waste gases for the purpose of the production of measurable heat, non-measurable heat or electricity provided that emissions that would have occurred from the combustion of an amount of natural gas, equivalent to the technically usable energy content of the combusted incompletely oxidised carbon, are subtracted:*

- (a) the chemical, electrolytic or pyrometallurgical reduction of metal compounds in ores, concentrates and secondary materials for a primary purpose other than the generation of heat;*
- (b) the removal of impurities from metals and metal compounds for a primary purpose other than the generation of heat;*
- (c) the decomposition of carbonates, excluding those for flue gas scrubbing for a primary purpose other than the generation of heat;*
- (d) chemical syntheses of products and intermediate products where the carbon bearing material participates in the reaction, for a primary purpose other than the generation of heat;*
- (e) the use of carbon containing additives or raw materials for a primary purpose other than the generation of heat;*
- (f) the chemical or electrolytic reduction of metalloids or non-metal oxides such as silicon oxides and phosphates for a primary purpose other than the generation of heat;*

In other words, the process emissions sub-installation can be any of the following, when the emissions occur within an ETS installation, but outside the boundaries of a product benchmark:

Type a) Non-CO<sub>2</sub> greenhouse gas emissions (i.e. N<sub>2</sub>O for specific sectors; see Annex I of the Directive for the list of activities for which N<sub>2</sub>O emissions are included in the EU ETS for Phase 4)

Type b) CO<sub>2</sub> emissions from any of the activities listed in this definition [(a) to (f)]

Type c) Emissions from the combustion of incompletely oxidised carbon such as CO emitted by any of these activities [(a) to (f)], if it is combusted to produce heat or electricity. Only emissions which are **additional** to the emissions that would occur if natural gas was used are taken into account. In calculating the additional emissions, the “technically usable energy content” should be considered. Compared to other fuels, most waste gases have a higher emission intensity and can therefore be used less efficiently compared to other fuels. A correction therefore needs to be applied for the difference in efficiencies between the use of waste gas and the use of natural gas as reference fuel.

Figure 1 illustrates these different types of process emissions, further described hereafter.

- *Type a process emissions*

Allocation for these emissions will be under the process emission sub-installation.

*For further guidance, see Guidance Document 2 on allocation methodologies at installation level.*

- *Type b process emissions*

Allocation for these emissions will be under the process emission sub-installation. For these process emissions, only activities [(a) to (f)] carried out within the scope of the EU ETS can be considered.

As specified in Article 10 (5) (h) of the FAR, process emissions of type b only cover CO<sub>2</sub> as direct and immediate result of the production process or chemical reaction, and as directly released to the atmosphere (as illustrated by the top-right box on Figure 1). CO<sub>2</sub> from the oxidation of CO or other incompletely oxidized carbon is not covered by type b process emissions, regardless of whether this oxidation takes place in the same technical unit or a separate one (but it would be covered by type c in case of energy recovery).

*For further guidance, see Guidance Document 2 on allocation methodologies at installation level.*

- *Type c process emissions*

Process emissions of type c refer to **waste gases**, and only activities [(a) to (f)] carried out within the scope of the EU ETS can be considered. Any CO<sub>2</sub> which is part of a gas mix including incompletely oxidized carbon which is not directly released to the atmosphere should be treated as part of the waste gas (and not as type b process emissions).

Only gas mixes containing **more than a negligible amount, i.e. more than 1 weight percent, of incompletely oxidized carbon** and containing enough energy itself to contribute to the production of heat or electricity can be regarded as waste gases in the context of the definition of the process emissions sub-installation of type c. This criterion should be considered fulfilled if:

1. The calorific value of the gas mix is high enough for the gas mix to burn without auxiliary fuel input;  
OR
2. The calorific value of the gas mix is high enough to contribute significantly to the total energy input when mixed with fuels of higher calorific value.

Allocation for waste gas emissions will only take place if the waste gases are efficiently used for the production of measurable heat, non-measurable heat or electricity. Combustion of waste gas in an open furnace (i.e. the part of incompletely oxidised carbon converted to CO<sub>2</sub> outside the furnace upon air exposure) is regarded as equal

to non-safety flaring (if the energy from the combustion is not recovered, and will therefore not receive free allocation on the basis of Article 10 (5) (h) of the FAR).

A specific rule applies where waste gases occurring outside the boundaries of product benchmarks are not used, mainly in cases of open furnaces, as the further oxidation of incompletely oxidised carbon is difficult to control. Given the unknown composition of such waste gases, i.e. the uncertainty about its CO<sub>2</sub> content, 75% of the quantity of the carbon content of the waste gas shall be considered as converted to CO<sub>2</sub>, and assigned to a process emissions sub-installation (Article 10 (5) (i) of the FAR).

*Example:* In an open furnace without energy recovery, a chemical reduction process leads to the production of a mix of CO and CO<sub>2</sub>. In the presence of air, the CO is further oxidised to CO<sub>2</sub> and as result, only CO<sub>2</sub> is released to the atmosphere. The CO<sub>2</sub> from the oxidation of CO that only occurs upon air exposure cannot be regarded as process emission type b. This is because only the CO<sub>2</sub> as *direct result of activities i to vi* (see definition above) can be considered as process emission of type b. However, the gas mix produced in the open furnace fulfils the criteria for waste gases as it contains incompletely oxidised carbon, is in a gaseous state under standard conditions and occurs as a result of one of the processes listed in the definition of process emissions. As this open furnace does not have equipment for energy recovery, a specific rule (Article 10 (5) (i) of the FAR) applies to consider that the gas mix contains a share of CO<sub>2</sub> which has been directly and immediately created (i.e. not by the oxidation of CO). According to this rules, 75% of the quantity of the carbon content of the waste gas shall be considered as converted to CO<sub>2</sub>, and assigned to a process emissions sub-installation and therefore is eligible for free allocation. .

*See chapter 4 of this Guidance Document for further details on the calculation of the allocation.*



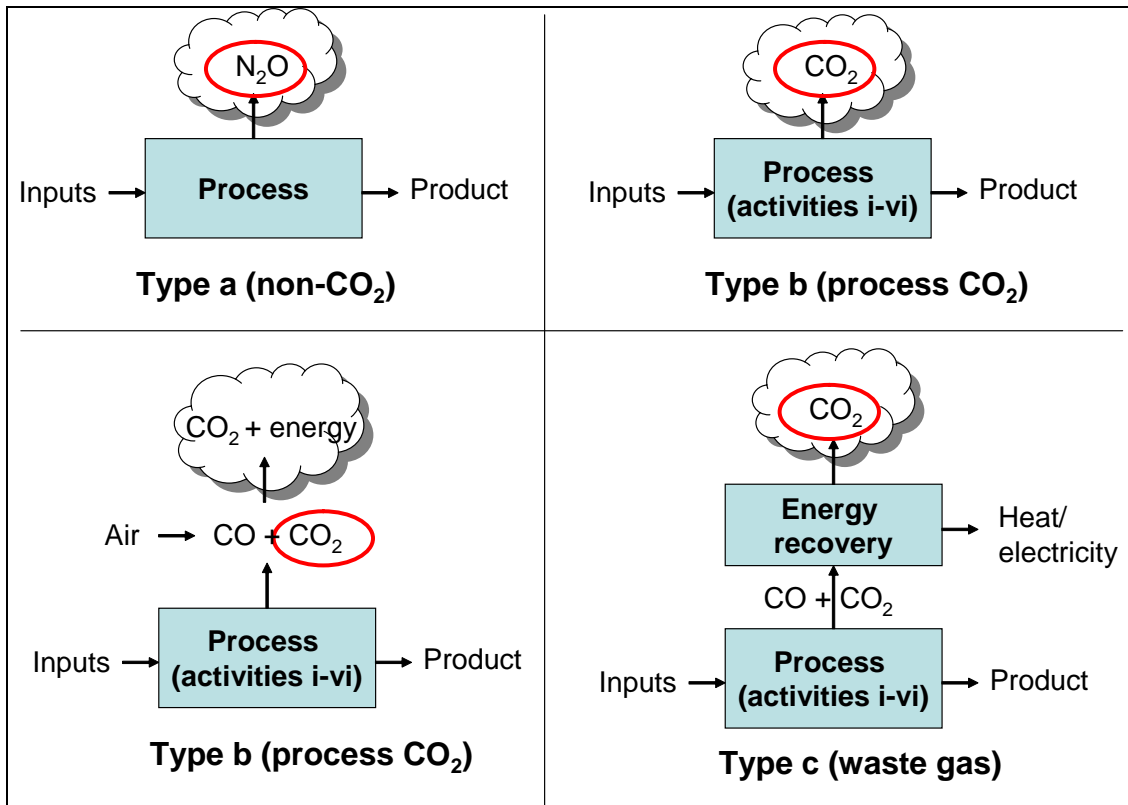

Figure 1 Overview of process emissions sub-installations (the emissions covered by the sub-installations are marked by the red ellipses; the bottom-left box illustrates the example of type b process emissions described in the text)

### **Flaring and safety flaring**

Further relevant for the free allocation of allowances to waste gases are the issues of flaring and safety flaring. According to Art.2(13) of the FAR:

*‘safety flaring’ means the combustion of pilot fuels and highly fluctuating amounts of process or residual gases in a unit open to atmospheric disturbances which is explicitly required for safety reasons by relevant permits for the installation;*

In other words, flaring can be considered as safety flaring if **all three** following conditions are met:

1. The flaring is required by relevant permit for safety reasons *AND*
2. The combustion takes place in a unit open to atmospheric disturbances (the combustion in other units is not covered) *AND*
3. The amounts of process or residual gases are highly fluctuating.

The third requirement can in particular be regarded as fulfilled if the flare does not operate continuously. Examples of flares that are not continuous are intermittent flares for either planned or unplanned activities such as maintenance and tests or unplanned events such as emergency situations or technical problems including in

connected installations usually using the waste gas. Continuously operating flares can be regarded to fulfill the third requirement if it can be demonstrated that the combusted amounts of residual gases are highly fluctuating on a day to day basis, i.e. that the residual gases are not produced in standard quantities resulting under normal operation as it is usually the case for batch processes. For this purpose the flared amounts over the entire baseline period should be considered and statistically analysed.

Please note that requirements in a permit are not sufficient to qualify a flare as safety flare, as in particular the criterion of high fluctuation needs to be met.

Safety flaring does not necessarily require that the residual gases flared are regarded as waste gases.

The emissions related to flaring include:

- a. Emissions from the combusted flared gas;
- b. Emissions from the combustion of fuels necessary to operate a flare, which are of two types:
  - i. The fuels necessary to keep a pilot flame running;
  - ii. The fuels required to successfully combust the flared gas.

In case of safety flaring of gases not resulting from processes covered by product benchmarks, the combusted flared gas and the fuels necessary to operate the flare are eligible for free allocation, **based on the fuel benchmark allocation methodology**. For other types of flaring, emissions from both origins are **not eligible** for free allocation.

The flaring of waste gases resulting from processes covered by a product benchmark, other than safety flaring, and not used for the purpose of the production of measurable heat, non-measurable heat or electricity, will lead to a reduction of allocation as of 2026, in line with Art.16(5). In this case, the preliminary annual allocation of the relevant product benchmark sub-installation will be reduced by the amount of annual historical emissions emitted from the flaring of these waste gases. For more information, see Section 4.1 of this document.

## 3 Background to waste gases in specific industries

Waste gases arise in, for example, the iron and steel industry and the chemical industry.

### 3.1 Iron and Steel and other metals industry

In the iron and steel industry waste gas arises in the coke oven, the blast furnace and the basic oxygen furnace, and are then often transferred to other installations (EU ETS or non-ETS installations) for energy recovery. CO<sub>2</sub> emissions from these waste gases therefore occur in the installation importing and recovering the waste gases:

- Coke making results in coke oven gas (COG), (emission factor: 44.7 tCO<sub>2</sub>/TJ, calorific value: 38.7 TJ/Gg)<sup>2</sup> which has a lower emission intensity than natural gas (NG) (56.1 tCO<sub>2</sub>/TJ, 48 TJ/Gg). In stand-alone coke oven plants, coke oven gas is used for under-firing of coke oven batteries.
- However, in integrated steel plants with an on-site coke oven plant, also blast furnace gas (BFG) is also used for the under-firing (259.4 tCO<sub>2</sub>/TJ, 2.5 TJ/Gg). This low-calorific gas – although usually considered as a fuel of very low value – is suitable for this purpose as it burns slowly and allows a more even distribution of heat across the walls of the coke oven chambers. In integrated steel works, blast furnace gas is used for many upstream processes (e.g. coke making) and downstream processes (e.g. rolling) as well as for electricity production, which may be outsourced. These processes, however, are also used in stand-alone configurations and in such situations have to rely on other fuels such as natural gas.
- Basic oxygen furnace gas (BOFG) is – as the name implies – produced in the basic oxygen furnace. the associated emission factor and calorific value is between COG and BFG (171.8 tCO<sub>2</sub>/TJ, 7.1 TJ/Gg). This gas can be used for both up- and downstream processes.

In addition, waste gases can be formed in high temperature reduction processes to produce metal alloys.

### 3.2 Chemical industry

In the chemical industry waste gases are formed during chemical reactions such as partial oxidisation, ammonium oxidisation and hydro-formylation used for the production of products such as carbon black, acetylene, olefins and synthesis gas. Also in the reduction of pure sand to silicon carbide using a carbon source waste gases are formed. To give an example, the tail gas from the carbon black process consists of 30-

---

<sup>2</sup> Emission factors and calorific values from EU Decision 2007/589/EC.

50% water vapour, 30-50% nitrogen, 1-5% CO<sub>2</sub> and small amounts of CO and H<sub>2</sub>. Once cooled at standard pressure and dried before transport, this low calorific mixture enables energy recovery by producing steam, hot water or electricity, and will hence meet the definition of a waste gas.

## 4 Calculation of Activity Levels and allocation

The calculation of Activity Levels and hence allocation related to waste gases is split into two parts, which can be included in different types of sub-installations:

- Allocation related to the production of waste gases (Part P in Figure 2; see section 4.1);
- Allocation related to the consumption of waste gases (Part C in Figure 2; see Section 4.2).

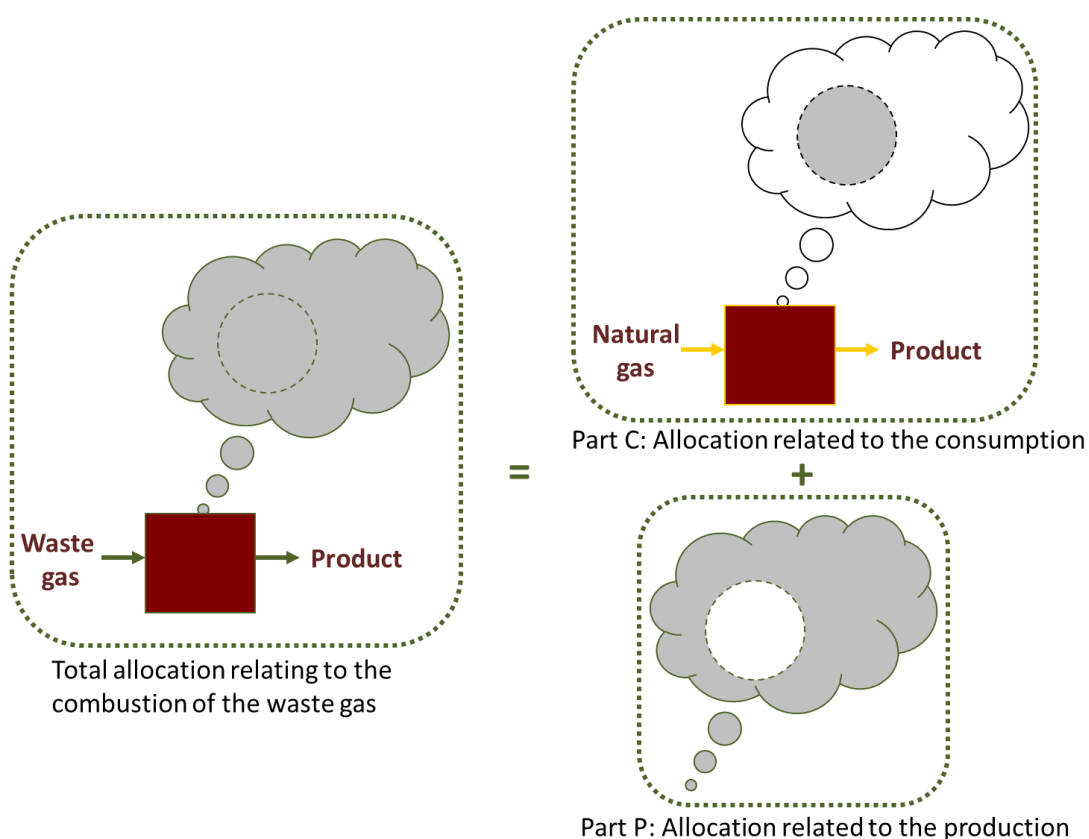

**Figure 2 Splitting allocation relating to waste gases between consumer and producer**

One important element to keep in mind (further detailed here-after) is that the **allocation relating to the production of the waste gas** will be allocated:

- to the **producer** of the waste gas in the case that the waste gas is produced within the boundaries of a product benchmark. This is because the emissions relating to this production are already included in the product benchmark (see also section **Error! Reference source not found.**). This part of the allocation may therefore go to an installation which does not emit the emissions relating to the combustion of the waste gas (where the consumer of the waste gas is a different entity from the producer of the waste gas);

- to the **consumer** of the waste gas in the case that the waste gas is produced outside the boundaries of a product benchmark. In this case, the allocation will go to the entity that emits the emissions related to combustion of the waste gas.

**Allocation related to the consumption of the waste gas** will always be allocated to the **consumer** of the waste gas.

In many cases however, the waste gases will be consumed on the site where they have been produced, and therefore the consumer and the producer will be the same installation.

To further clarify this approach, Section 4.3 describes the total allocation in the case of waste gas production inside and outside the boundaries of a product benchmark. To provide an easy to use reference, Section 4.4 gives a complete summary of allocation methods to be used in the case of waste gas production and consumption.

#### **4.1 Allocation relating to the production of the waste gas**

For the allocation related to the production of waste gases, only emissions additional to emissions that would come from the combustion of the reference fuel – natural gas – are accounted for. The remaining emissions can, depending on the use of the waste gas, be allocated based on an allocation methodology relevant for waste gas consumption (see section 4.2). This guidance document focuses on the determination of Activity Levels for the calculation of allocation. *For more guidance specifically on the attribution of emissions, see Guidance Document 5 on Monitoring & Reporting for the FAR.*

##### **Case 1: Waste gases produced within the boundaries of a product benchmark**

If the waste gas is produced within the boundaries of a benchmarked product, the allocation relating to production of the waste gas and the allocation related to safety flaring (see Figure 3) are already included in the determination of the product benchmark. Therefore, allocation for the production of the waste gas (part P in Figure 2) is granted to the producer of the waste gas and is included in the product benchmark sub-installation.

The consumer of the waste gas receives no additional allocation for the production of the waste gas (part P in Figure 5). The consumer can however receive allocation for the consumption of the waste gas (part C in Figure 2; see section 4.2).

If the waste gas is ultimately flared for reasons other than safety flaring, then as of 2026, the preliminary allocation based on the product benchmark sub-installation that the waste gas producer will receive, will be reduced by the amount of emissions from

the flaring of this waste gas. In this case, the preliminary allocation of this sub-installation will be determined as follows<sup>3</sup>:

**For 2021-2025:**

$$F_{p,k} = BM_p \times HAL_p \times CLEF_{p,k}$$

**For 2026-2030:**

$$F_{p,k} = (BM_p \times HAL_p - \text{Arithmetic mean}_{\text{BaselinePeriod}} (V_{WGfl} \times NCV_{WG} \times EF_{WG})) \times CLEF_{p,k}$$

Where:

- $F_{p,k}$  the annual preliminary allocation for product  $p$  in year  $k$  (expressed in EUAs/yr);
- $BM_p$  the product benchmark value for product  $p$  (expressed in EUAs / unit of product);
- $HAL_p$  the historical activity level of product  $p$ , i.e. the arithmetic mean of the annual production in the baseline period as determined and verified in the baseline data collection (expressed in unit of product). See Guidance Document 9 with Sector Specific Guidance for the unit of production to be used for different products.;
- $CLEF_{p,k}$  the applicable Carbon Leakage Exposure Factor for product  $p$  in year  $k$ ;
- $V_{WGfl}$  the volume of waste gas flared for reasons other than safety flaring (expressed in  $Nm^3$  or tonnes);
- $NCV_{WG}$  the Net Calorific Value of the waste gas (expressed in  $TJ/Nm^3$  or  $TJ/t$ );
- $EF_{WG}$  the emission factor of the waste gas (expressed in  $tCO_2/TJ$ ).

Note that producer and consumer can be the same installation.

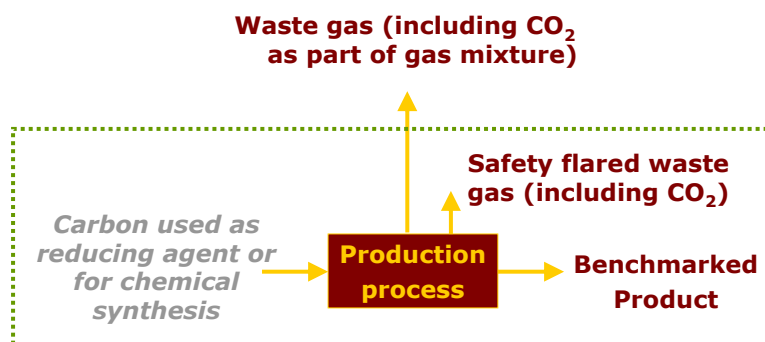

Figure 3 Emission of waste gases within the boundaries of a product benchmark<sup>4</sup>

### **Case 2: Waste gases produced outside the boundaries of a product benchmark**

If the waste gas is produced outside the boundaries of a product benchmark, and if this waste gas is recovered (i.e. it is not ultimately flared for reasons other than safety flaring), a fall-back approach is applied (see Figure 4). The emissions relating to the

<sup>3</sup> To be adjusted by special product benchmark factors or for exchangeability of fuel and electricity if relevant. See Guidance Document 2 on allocation methodologies for more information.

<sup>4</sup> The emissions related to the consumption of the waste gas (part C in Figure 2) are not represented here. Furthermore, emissions from the flaring of waste gases for reasons other than for safety reasons are included in the boundaries until 2025, and will be deducted as from 2026.

production of the waste gas (part P in Figure 2), which is recovered for the production of measurable heat, non-measurable heat or electricity, will be regarded as a process emissions sub-installation. Emissions from waste gases that are flared are not considered as process emissions and will not be eligible for free allocation, except in the case of safety flaring, where allocation will be calculated based on the fuel benchmark (see chapter 2 for a discussion on the definition of safety flaring).

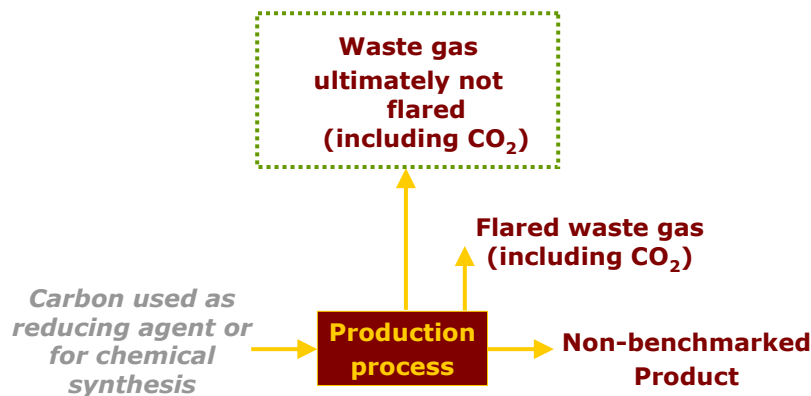

**Figure 4** Emission of waste gases outside the boundaries of a product benchmark. The green dashed line shows the boundaries of a process emissions sub-installation<sup>5</sup>

As the emissions related to the waste gas occur when the waste gas is combusted, the preliminary allocation will be given to the consumer of the waste gas. The preliminary free allocation is obtained by multiplying the historical activity level ( $HAL_{WasteGas}$ ) with a factor 0.97 and with the Carbon Leakage Exposure Factor (CLEF):

$$F_{pe,k} = HAL_{WasteGas} \times 0.97 \times CLEF_{pe,k}$$

The historical activity level of this sub-installation is determined as follows:

$$HAL_{WasteGas} = \text{Arithmetic mean}_{BaselinePeriod} [V_{WG} \times NCV_{WG} \times (EF_{WG} - EF_{NG} \times Corr_{\eta})]$$

Where:

- $F_{pe,k}$  the annual preliminary allocation for the process emissions sub-installation in year  $k$  (expressed in EUAs/yr);
- $HAL_{WasteGas}$  the Historical Activity Level of the sub-installation related to the production of waste gases not covered by a product benchmark (expressed in tCO<sub>2</sub>e);
- $CLEF_{pe,k}$  the applicable Carbon Leakage Exposure Factor for the process emissions sub-installation in year  $k$ ;
- $V_{WG}$  the volume of waste gas that is not flared (expressed in Nm<sup>3</sup> or tonnes);
- $NCV_{WG}$  the Net Calorific Value of the waste gas (expressed in TJ/Nm<sup>3</sup> or TJ/t);
- $EF_{WG}$  the emission factor of the waste gas (expressed in tCO<sub>2</sub>/TJ);

<sup>5</sup> The emissions related to the consumption of the waste gas (part C in Figure 2) are not represented here.



$EF_{NG}$	<i>the emission factor of natural gas (56.1 tCO<sub>2</sub>/TJ).</i>
$Corr_{\eta}$	<i>is a factor that accounts for the difference in efficiencies between the use of waste gas and the use of the reference fuel natural gas, the default value of this factor is equal to 0.667.</i>

In the case where the emission factor of the waste gas is lower than the corrected emission factor of natural gas,  $HAL_{WasteGas}$  should be considered equal to zero. In other words,  $HAL_{WasteGas}$  cannot be negative.

The content of CO<sub>2</sub> in the waste gas is treated as part of the waste gas stream. Therefore, the values for the volume, the Net Calorific Value and the emission factor of the waste gas are referring to the total waste gas stream including CO<sub>2</sub>.<sup>6</sup>

A default correction factor ( $Corr_{\eta}$ ) of 0.667 should be used unless the operator can provide acceptable data proving that a different factor should be used. Different factors should only be used if the uses of waste gas and efficiencies related to these uses are known.

## 4.2 Allocation relating to the consumption of the waste gas

Regardless of the composition of the waste gas and of its origin, the *use* of a waste gas (part C in Figure 2) is treated as for any other fuel:

- When it is used to produce electricity or when it is flared, there will be no allocation for this activity (except in the case of safety flaring of waste gases produced outside the boundaries of a product benchmark. In that case allocation will occur using the fuel benchmark);
- When it is used in the production of a benchmarked product, the allocation is already taken into account in the benchmark for this product;
- When it is used to produce measurable heat, the consumption of this heat will be allocated based on the heat benchmark (if heat consumption is not already covered by a product benchmark);
- When it is used as a combustion fuel for the production of non-measurable heat and not used for electricity production, the sub-installation consuming this fuel will receive an allocation based on the fuel benchmark.

---

<sup>6</sup> The same approach has been applied to waste gases covered by product benchmarks.

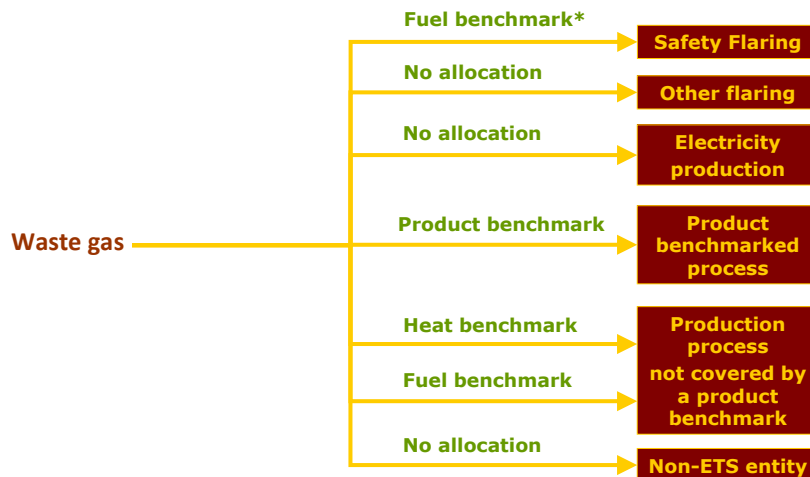

Figure 5 Allocation for the consumption of waste gases (part C in Figure 2); \*Safety flaring only receives allocation based on a fuel benchmark in case the flared waste gas is produced outside the boundaries of a product benchmark

### 4.3 Total allocation for production and consumption of waste gases

#### ***Case 1: Waste gases produced within the boundaries of a product benchmark***

Figure 6 gives an overview of allocation methodologies to be used in the case of production of waste gases inside the boundaries of a product benchmark:

- **The allocation for waste gas production** (part P in Figure 2) is taken into account by the product benchmark. This allocation goes to the producer of the waste gas. If the waste gas is ultimately flared, the corresponding emissions will be subtracted from the free allocation as of 2026.
- **The allocation for waste gas use** (part C in Figure 2, if applicable) goes to the user of the waste gas. Figure 6 shows which allocation methodology should be used for different types of consumers.

In many cases, the waste gases will be consumed on-site, and therefore the consumer and the producer will be the same installation.

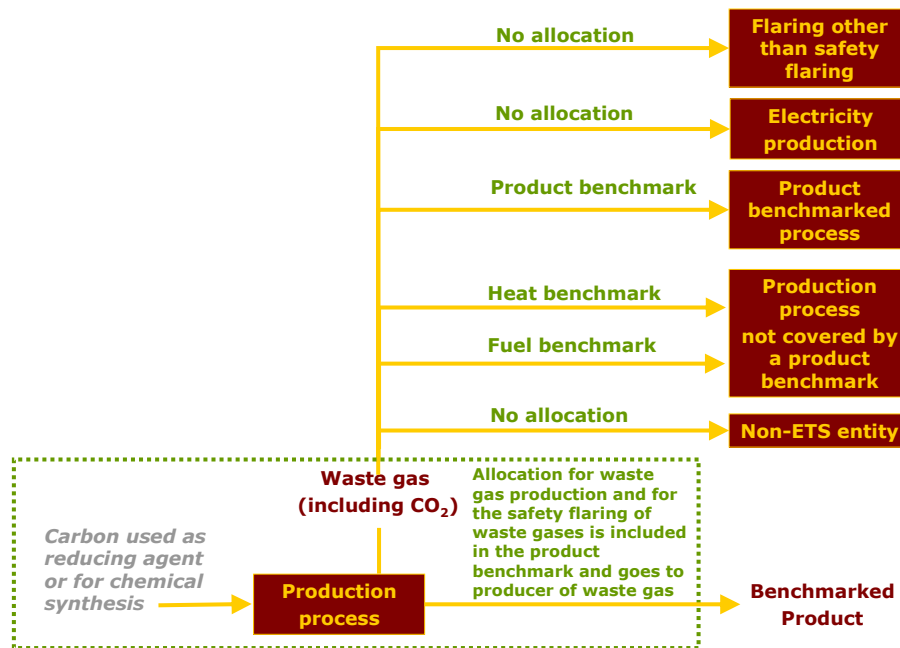

Figure 6 Overview of allocation in case of production of waste gases within the boundaries of a product benchmark

***Case 2: Waste gases produced outside the boundaries of a product benchmark***

Figure 7 gives an overview of allocation methodologies to be used in the case of production of waste gases outside the boundaries of a product benchmark:

- **The allocation for the production of waste gases that are ultimately not flared** (part P in Figure 2, and allocation indicated with dotted lines in Figure 7) is based on the approach for the process emission sub-installation (see equation 1; section 4.1). This allocation goes to the user of the waste gas. If the waste gas is used by more than one ETS installation, the allocation is distributed between these installations based on the amounts of waste gases used by each of the different ETS installations.
- **The allocation for waste gas use** (Part C in Figure 2, if applicable) goes to the user of the waste gas. Figure 7 shows which allocation methodology should be used for different types of consumers.

In many cases, the waste gases will be consumed on-site, and therefore the consumer and the producer will be the same installation.

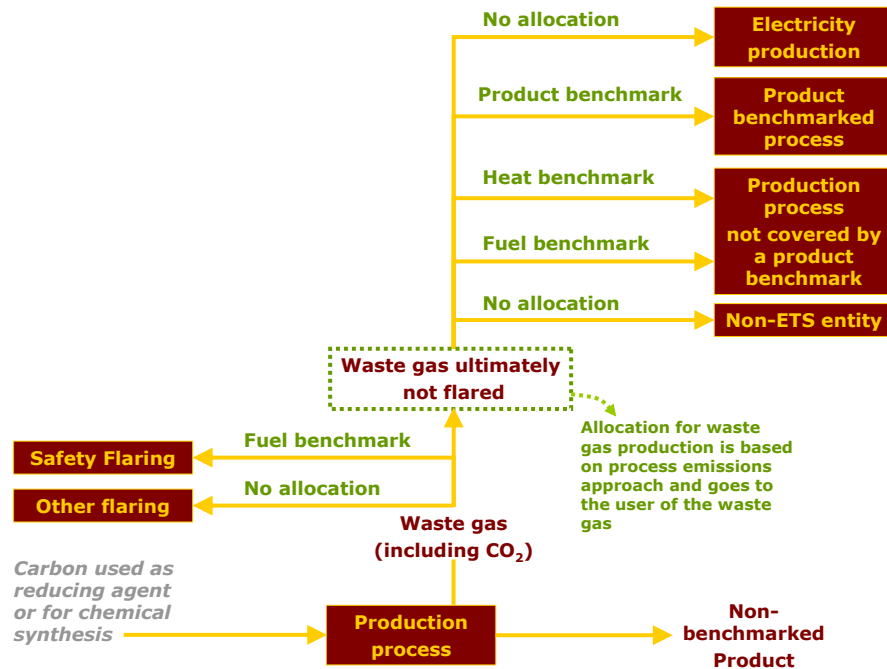

**Figure 7** Overview of allocation in case of production of waste gases outside the boundaries of a product benchmark. The green dashed line indicates the boundaries of a process emissions sub-installation

Care must be taken that no allocation is given twice relating to the same carbon content: once for the waste gas via the process emission sub-installation, and once via a fuel benchmark sub-installation:

- Fuel used as reducing agent or for chemical syntheses should not be considered as fuel input into a fuel benchmark sub-installation.
- Any fuel which will ultimately end up in the waste gases should not be allocated via a fuel benchmark sub-installation.

To avoid double counting, the Historical Activity Level of the fuel benchmark sub-installation covering the fuel input to the production process causing the waste gases (see below-left in Figure 7) should be determined as follows:

$$HAL_{fuel} = Arithmetic\ mean_{baseline} [Fuel_{Process} - V_{WG} \times NCV_{WG} \times \alpha]$$

Where:

- $HAL_{fuel}$  the Historical Activity Level of the fuel sub-installation;
- $Arithmetic\ mean_{baseline}$  the arithmetic mean value over the baseline period;
- $Fuel_{process}$  the total amount of fuel consumed in the production process excluding fuel used as reducing agent or chemical syntheses (expressed in TJ);
- $V_{WG}$  the total volume of waste gas exiting the production process (expressed in  $Nm^3$  or tonnes);
- $NCV_{WG}$  the Net Calorific Value of the waste gas (expressed in  $TJ/Nm^3$  or  $TJ/t$ );
- $\alpha$  the share of waste gases originating from the fuel.

The Historical Activity Level of the fuel benchmark sub-installation covering safety flaring (see top box on the left in Figure 7) should be determined as follows:

$$HAL_{fuel} = \text{Arithmetic mean}_{baseline} [Fuel_{SafetyFlaring} + V_{WG} \times NCV_{WG} \times \beta]$$

Where:

$HAL_{fuel}$	<i>the Historical Activity Level of the fuel sub-installation;</i>
$\text{Arithmetic mean}_{baseline}$	<i>the arithmetic mean value over the baseline period;</i>
$Fuel_{SafetyFlaring}$	<i>the total amount of fuel necessary for safety flaring; i.e. the fuels necessary to keep a pilot flame running and fuels required to successfully combust the flared gas (expressed in TJ);</i>
$V_{WG}$	<i>the total volume of waste gas exiting the production process (expressed in Nm<sup>3</sup> or tonnes);</i>
$NCV_{WG}$	<i>the Net Calorific Value of the waste gas (expressed in TJ/Nm<sup>3</sup> or TJ/t);</i>
$\beta$	<i>the share of total waste gases that is flared for safety reasons.</i>

Note that safety flaring and the fuel input to the production process could be covered by the same fuel benchmark sub-installation. In that case, the historical activity level would be:

$$HAL_{fuel} = \text{Arithmetic mean}_{baseline} [Fuel_{Process} - V_{WG} \times NCV_{WG} \times \alpha + Fuel_{SafetyFlaring} + V_{WG} \times NCV_{WG} \times \beta]$$

#### 4.4 Summary of allocation methodologies in the case of waste gases

Table 1 summarises the allocation for the production of waste gases within or outside the system boundaries of a product benchmark and the various types of waste gas consumption.

**Table 1. Summary of allocation approaches for waste gases produced and consumption within or outside the boundaries of a product benchmark.**

<b>Production</b>	<b>Consumption</b>	<b>Type of consumption</b>	<b>Allocation for production to producer</b>	<b>Allocation for consumption to consumer</b>
Inside system boundary of PBM	Inside system boundary of PBM	Product BM	Product BM	Product BM
		Safety flare	Product BM	n.a. <sup>1</sup>
		Flare	Product BM, deduction of emissions from flared WG as of 2026	n.a. <sup>1</sup>
	Outside system boundary of PBM	Measurable heat	Product BM	Heat BM
		Non-measurable heat	Product BM	Fuel BM
		Safety flare	Product BM	n.a. <sup>1</sup>
		Flare	Product BM, deduction of emissions from flared WG as of 2026	n.a. <sup>1</sup>
		Electricity	Product BM	None
	<b>Production</b>	<b>Consumption</b>	<b>Type of consumption</b>	<b>Allocation for production to consumer</b>
Outside system boundary of PBM	Inside system boundary of PBM	Product BM	Formula in 4.1, Case 2	Product BM
	Outside system boundary of PBM	Measurable heat	Formula in 4.1, Case 2	Heat BM
		Non-measurable heat	Formula in 4.1, Case 2	Fuel BM
		Safety flare	None	Fuel BM
		Flare	None	None
		Electricity	Formula in 4.1, Case 2	None

<sup>1</sup> Flares and safety flares from waste gases produced within the system boundaries of a product benchmark, are already taken into account in determining the product benchmark. As of 2026, the emissions from flaring of waste gases for reasons other than safety flaring will be deducted from the allocation based on product benchmarks (see Section 4.1).

## 5 Case Studies

In this section, three case studies are presented:

**Example 1:** The extensive example detailed in Guidance Document 2 is presented here with a focus on the treatment of waste gases: how to define the relevant sub-installations and what data are the key ones to take into account.

**Example 2:** The second example shows how to calculate the allocation in the case of waste gases produced within the boundaries of a benchmarked product. The example of an iron and steel plant is given, which sells its waste gases to a third-party that used part of them to generate electricity, and part for heat production.

**Example 3:** The third example shows how to calculate the allocation in the case of waste gases produced outside the boundaries of a benchmarked product. The example of a chemical plant is given, which uses part of its waste gases on site for electricity production, sells part of its waste gases to a third party for heat production, and flares the remainder.

### 5.1 Example 1 – defining sub-installations linked to waste gases

In this example plant, 3 products are produced:

- P2, which is a benchmarked product,
- P1 and P3 which are non-benchmarked products.

Each of these products consumes fuel and heat and produce waste gases (see Figure 8). The remainder of this section discusses:

- Issue 1: waste gases produced in the production process of product P2;
- Issue 2: waste gases produced in the production processes of products P1 and P3;
- Issue 3: waste gases consumed within the installation to produce steam;
- Issue 4: waste gases flared;
- Issue 5: impact on the fuel benchmark sub-installation.

For more information on other aspects of this example, see *Guidance Document 2 on Allocation Methodologies at the Installation level*.

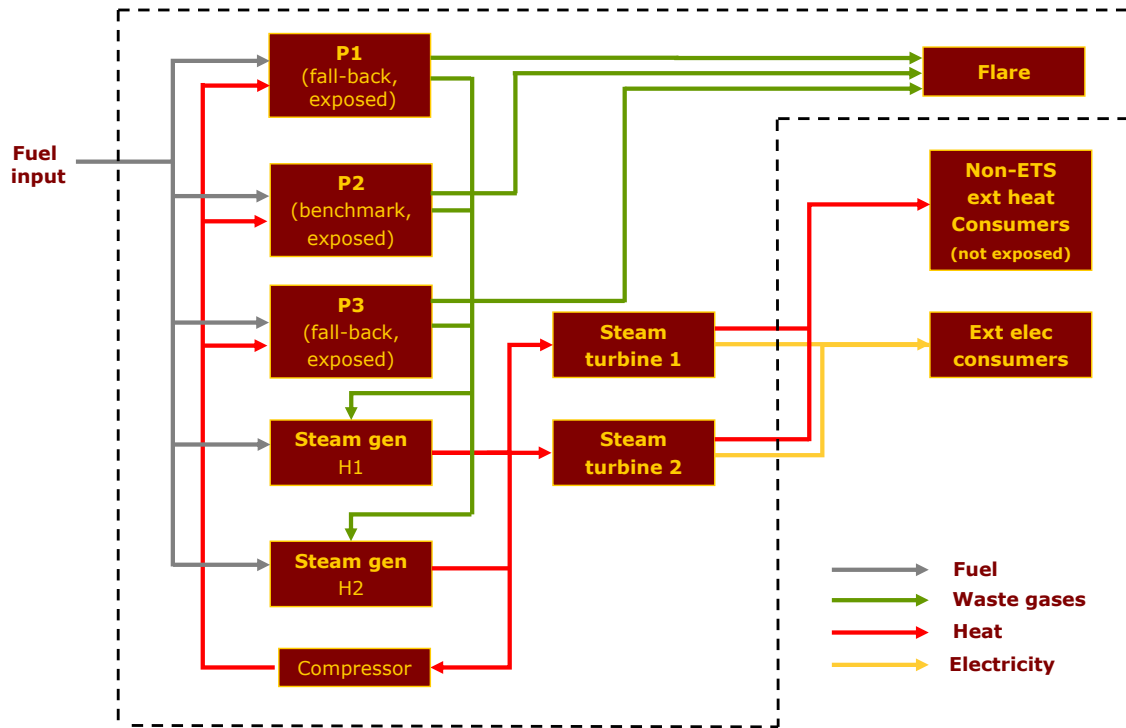

Figure 8 Example 1 installation boundaries; Raw material flows are not shown (e.g. carbon used as reducing agent or chemical synthesis).

• **Issue 1: waste gases produced in process P2**

Product P2 is a benchmarked product. Therefore, allocation to the producer of waste gases is based on the product benchmark of P2 (see Figure 9). Data relating to the waste gas will only be needed if the waste gas is ultimately flared for reasons other than safety flaring, as otherwise the allocation will only be based on P2 production data.

The preliminary allocation of this sub-installation from 2021 to 2025 will be:

$$F_{p,k} = BM_P \times HAL_P \times CLEF_{p,k}$$

And as from 2026, it will be:

$$F_{p,k} = (BM_P \times HAL_P - Em_{WGfl}) \times CLEF_{p,k}$$

With:

$$Em_{WGfl} = \text{Arithmetic mean}_{\text{BaselinePeriod}} (V_{WGfl} \times NCV_{WG} \times EF_{WG})$$

Where:

- $F_{p,k}$  the annual preliminary allocation for product  $p$  in year  $k$  (expressed in EUAs/year);
- $BM_P$  the relevant product benchmark value (expressed in EUAs / unit of product);
- $HAL_P$  the historical activity level of the product benchmark sub-installation (expressed in unit of product;)



- $CLEF_{p,k}$  the applicable Carbon Leakage Exposure Factor for product  $p$  in year  $k$ ;
- $Em_{WGfl}$  the annual amount of emissions from flared waste gases during the relevant baseline period (expressed in  $tCO_2/yr$ );
- $V_{WGfl}$  the volume of waste gas flared for reasons other than safety flaring (expressed in  $Nm^3$  or tonnes);
- $NCV_{WG}$  the Net Calorific Value of the waste gas (expressed in  $TJ/Nm^3$  or  $TJ/t$ );
- $EF_{WG}$  the emission factor of the waste gas (expressed in  $tCO_2/TJ$ ).

Allocation to the consumer of waste gases produced by process P2 are discussed as issues 3 and 4.

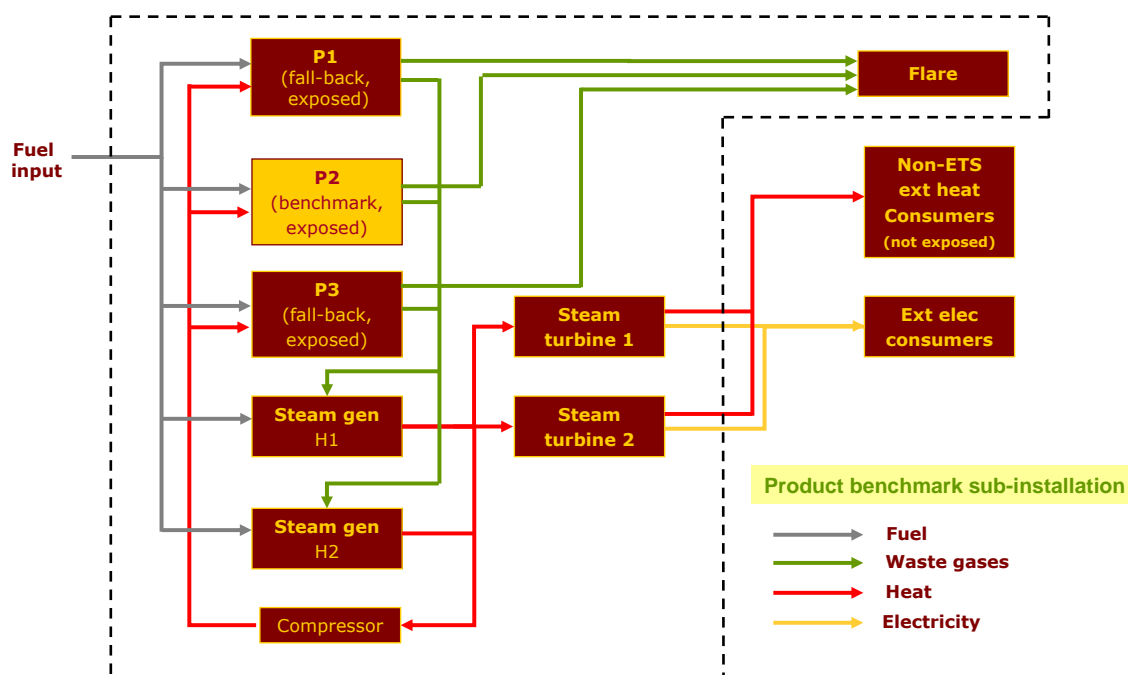

Figure 9 Example 1 – Waste gases produced by P2 (highlighted process) are included in the product benchmark P2; Raw material flows are not shown (e.g. carbon used as reducing agent or chemical synthesis).

- **Issue 2: waste gases produced in processes P1 and P3**

As P1 and P3 are not benchmarked products. Allocation to these processes is determined considering the production of these waste gases as process emissions, and is given to the consumer of these waste gases (steam gen H1 and H2; where the emissions occur). In this example, as the consumer is also the producer of the waste gas, this sub-installation will be part of this installation; if the waste gas had been sold to an ETS-installation, the latter would have received the allocation.

Waste gases from both P1 and P3 will be part of the same process emission sub-installation (see Figure 10). If, additional and physically separate, process emissions of type a or type b were emitted within the boundaries of the installation, these would have been included in this sub-installation as well.

The preliminary allocation of this sub-installation will be:

$$F_{i,k} = \text{Reduction factor} \times \text{HAL} \times \text{CLEF}_{i,k}$$

With:

$$\text{HAL} = \text{Arithmetic mean}_{\text{BaselinePeriod}} [V_{\text{WG}} \times \text{NCV}_{\text{WG}} \times (\text{EF}_{\text{WG}} - \text{EF}_{\text{NG}} \times \text{Corr}_{\eta})]$$

Where:

- $F_{i,k}$  the annual preliminary allocation for sub-installation  $i$  in year  $k$  (expressed in EUAs/year);
- Reduction factor 0.97
- $\text{CLEF}_{i,k}$  the applicable Carbon Leakage Exposure Factor for sub-installation  $i$  in year  $k$ ;
- $V_{\text{WG}}$  Non-flared volume of waste gas in  $\text{Nm}^3$  or tonnes;
- $\text{NCV}_{\text{WG}}$  Net Calorific Value of the waste gas in  $\text{TJ}/\text{Nm}^3$  or  $\text{TJ}/\text{t}$ ;
- $\text{EF}_{\text{WG}}$  Emission factor of the waste gas in  $\text{tCO}_2/\text{TJ}$ ;
- $\text{EF}_{\text{NG}}$  Emission factor of natural gas (=  $56.1 \text{ tCO}_2/\text{TJ}$ );
- $\text{Corr}_{\eta}$  Correction factor to take into account the technically usable energy content; compared to natural gas (for the use of electricity production, a default value of 0.667 can be used).

Allocation to the consumer of waste gases produced by processes P1 and P3 are discussed as issues 3 and 4

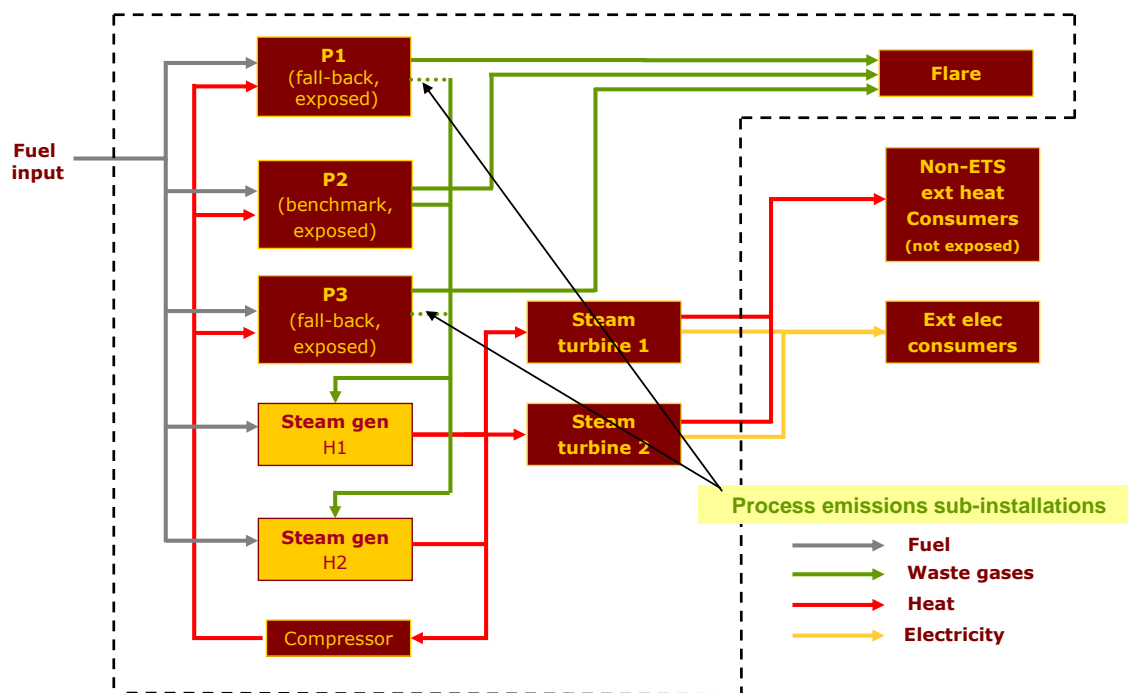

Figure 10 Example 1 – Waste gases from non-benchmarked products (P1 and P3) are included in a process emissions sub-installation<sup>7</sup>. The allocation related to these process

<sup>7</sup> This refers to the ‘Production part’ of the waste gases, see Figure 2 for more information.

emissions goes to the waste gas consuming process (in this example: Steam gen H1 and H2 which are part of the same installation); Raw material flows are not shown (e.g. carbon used as reducing agent or chemical synthesis).

- **Issue 3: waste gases consumed within the installation to produce steam**

The emissions linked to the use of the waste gases to generate steam are covered by the heat sub-installations allocating allowances to the heat consumers on the basis of the heat benchmark. The data needed to calculate this allocation will be the arithmetic mean of the amount of heat consumed over the baseline period by the relevant heat consumers (heat consumed to produce P1 and P3 in the case of the sub-installation in Figure 11, and heat exported to external heat consumers in the case of Figure 12). These are split into 2 sub-installations to take into account the different carbon leakage status of each sub-installation (see *Guidance Documents 2 on allocation methodologies and on carbon leakage for more guidance on this*).

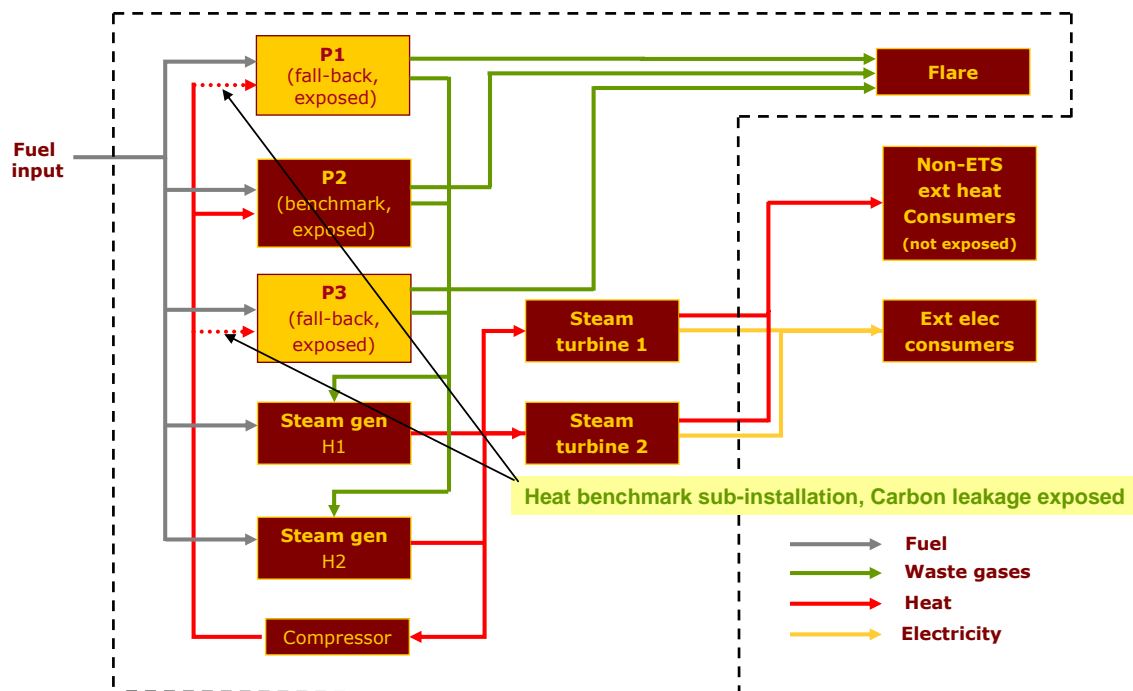

Figure 11 Example 1 – P1 and P3 receive allocation for consumed heat that was partially produced using waste gases; Raw material flows are not shown (e.g. carbon used as reducing agent or chemical synthesis).

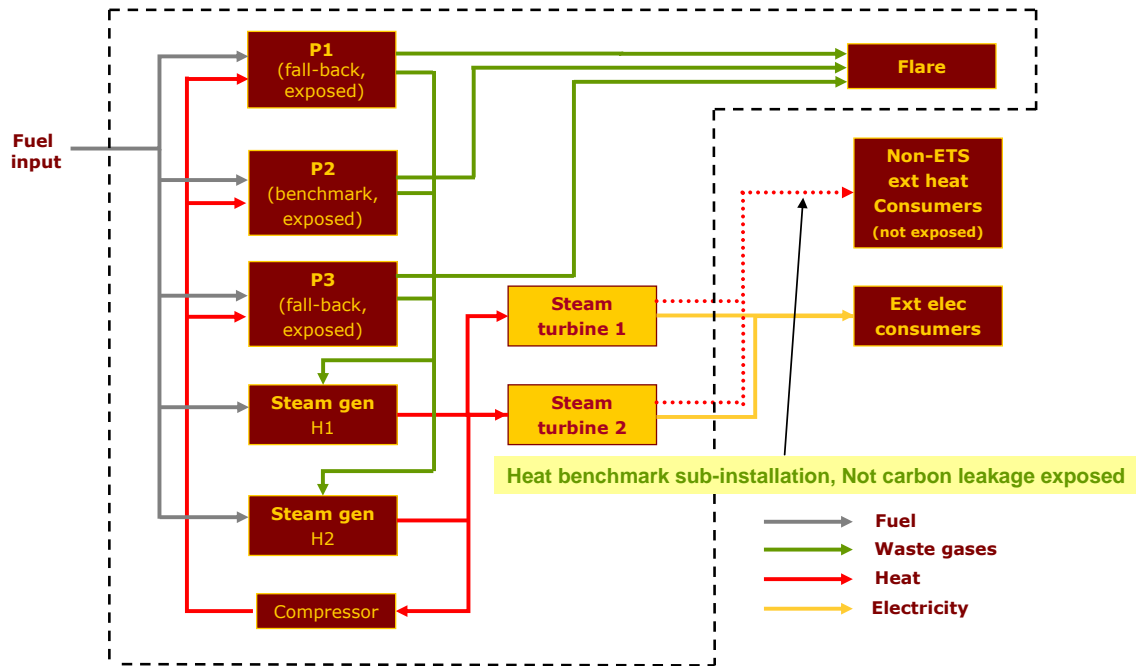

Figure 12 Example 1 – Steam turbines 1 and 2 receive allocation for the heat exported to external non-ETS heat consumers; The exported heat was partially produced using waste gases; Raw material flows are not shown (e.g. carbon used as reducing agent or chemical synthesis).

- **Issue 4: waste gases flared**

Emissions from the flaring of waste gases are not eligible for free allocation, unless the flaring meets the criteria for safety flaring (see Section 2.2), in which case there will be an allocation.

Safety flaring of waste gases produced by processes P1 and P3 will be included in the fuel sub-installation of the plant (see issue 5 hereafter). Safety flaring (and more generally all flaring) of waste gases produced by P2 is already accounted for in the product benchmark for P2 and is not eligible for free allocation under a fuel benchmark.

If the flaring of the waste gas does not meet the criteria for safety flaring, then the amount of emissions corresponding to the share of flared waste gas produced by P2 need to be deducted from the P2 product benchmark sub-installation as of 2026 (see issue 1).

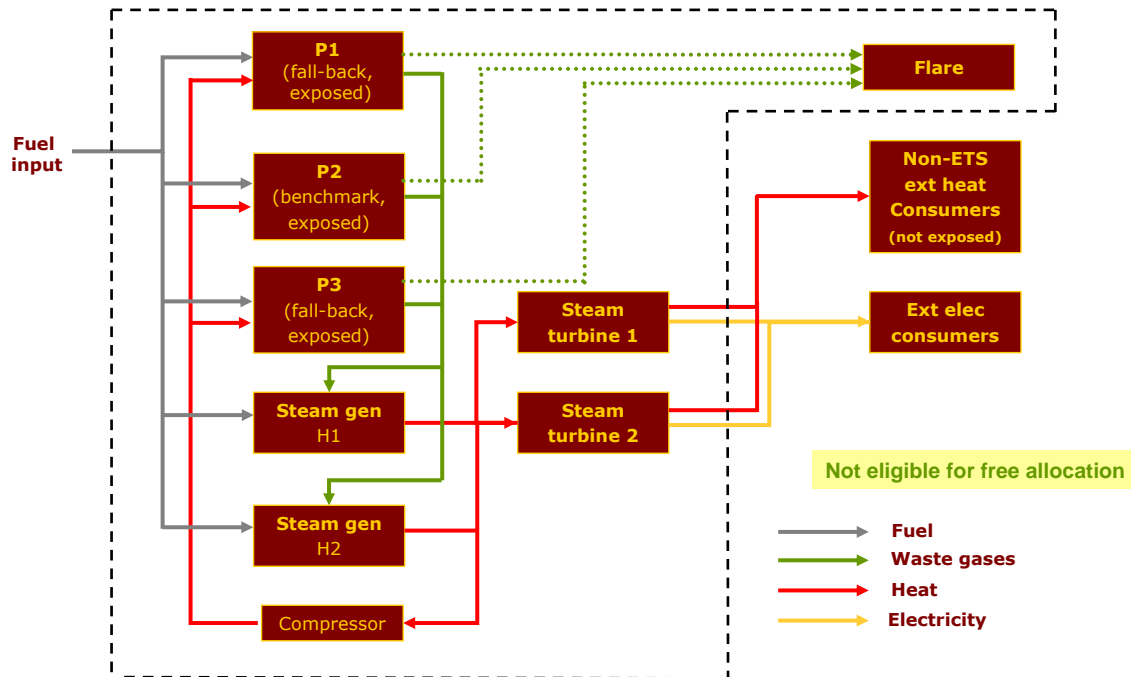

Figure 13 Example 1 – Flaring (except for safety flaring) is not eligible for free allocation.

• **Issue 5: impact on the fuel benchmark sub-installation**

If some fuels used to produce P1 and P3 are converted into waste gases, their quantity cannot be allocated to the fuel benchmark sub-installation (see Figure 14). Therefore, the preliminary allocation to the fuel sub-installation should be:

$$F_{fuel,k} = BM_{fuel} \times HAL_{fuel} \times CLEF_{fuel,k}$$

With:

$$HAL_{fuel} = \text{Arithmetic mean}_{baseline} [Fuel_{Process} - V_{WG} \times NCV_{WG} \times \alpha + Fuel_{SafetyFlaring} + V_{WG} \times NCV_{WG} \times \beta]$$

Where:

$F_{fuel,k}$  the annual preliminary allocation for the fuel sub-installation in year k (expressed in EUAs/year);

$BM_{fuel}$  XX allowances/TJ;

$HAL_{fuel}$  the Historical Activity Level of the fuel sub-installation;

$CLEF_{fuel,k}$  is the applicable Carbon Leakage Exposure Factor for the fuel sub-installation in year k;

$\text{Arithmetic mean}_{baseline}$  the arithmetic mean value over the baseline period;

$Fuel_{process}$  the total amount of fuel consumed in production processes 1 and 3 excluding fuel used as reducing agent or chemical syntheses (expressed in TJ);

$V_{WG}$  the total volume of waste gas exiting the production process (expressed in Nm<sup>3</sup> or tonnes);

$NCV_{WG}$  the Net Calorific Value of the waste gas (expressed in TJ/Nm<sup>3</sup> or TJ/t)

$Fuel_{SafetyFlaring}$  the total amount of fuel necessary for safety flaring; i.e. the fuels necessary to keep a pilot flame running and fuels required to successfully combust the flared gas (expressed in TJ);

$\alpha$  the share of waste gases originating from the fuel;

$\beta$

the share of total waste gases that is flared in accordance with the definition of safety flaring.

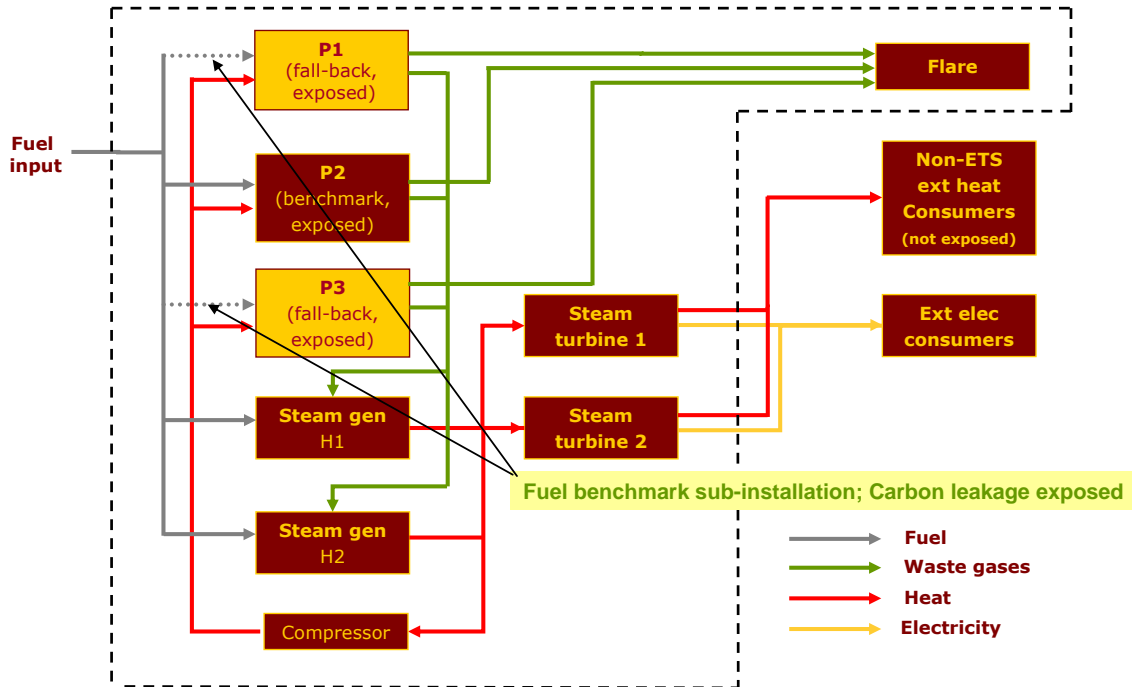

Figure 14

Example 1 – Fuel combusted in processes P1 and P2 is eligible for free allocation. This fuel benchmark sub-installation also includes any safety flaring of waste gases produced by P1 and P2, but excludes fuels that are converted into waste gases.

## 5.2 Example 2 – allocation in the case of a benchmarked product

In this example, an integrated steel plant:

- Uses part of its Blast Furnace Gas (BFG) for under-firing the stoves;
- Sells the remaining BFG to:
  - a power plant (covered by the EU ETS);
  - another installation covered by the EU ETS (plant A) using the BFG for heat production.
- Uses its Coke Oven Gas (COG) for under-firing and flares the remaining amount (see Figure 15).

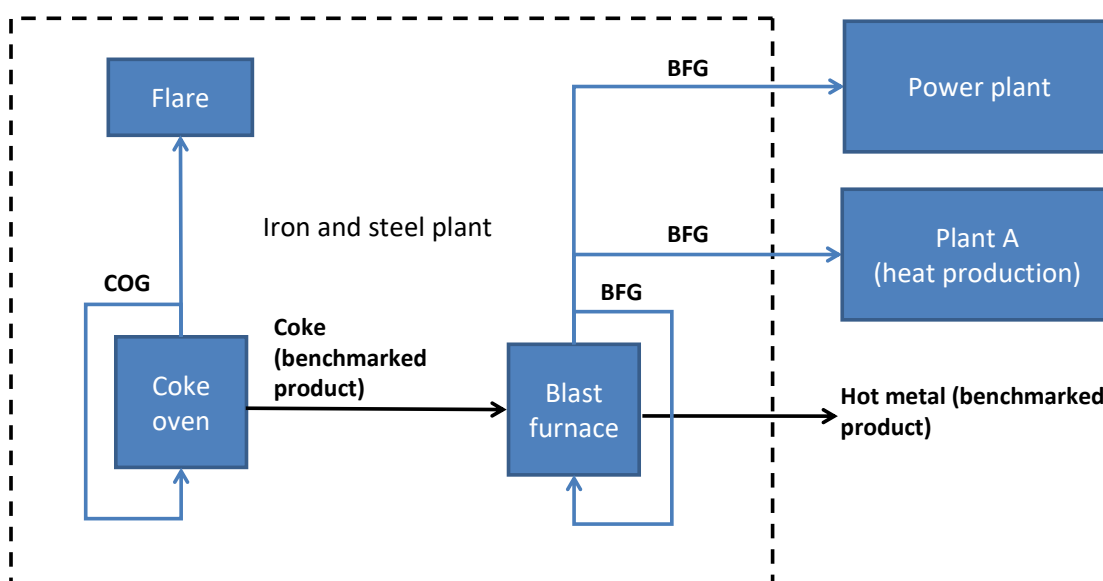

Figure 15 Example 2 – Waste gases produced within a product benchmark

The preliminary allocation to the steel plant will be the following, regardless of whether the waste gas is used for direct or indirect heating, or for electricity production:

$$F_{inst,k} = BM_{hot\ metal} \times HAL_{hot\ metal} \times CLEF_{hot\ metal,k} + (BM_{coke} \times HAL_{coke} - Em_{COGfl}) \times CLEF_{coke,k}$$

With:

Until 2025:  $Em_{COGfl} = 0$

As of 2026:  $Em_{COGfl} = \text{Arithmetic mean}_{\text{BaselinePeriod}} (V_{COGfl} \times NCV_{COG} \times EF_{COG})$

Where:

$F_{inst,k}$  the annual preliminary allocation for the installation in year  $k$  (expressed in EUAs/year);

$BM_{hot\ metal}$  **XXX** allowances/t hot metal;

$HAL_{hot\ metal}$	the arithmetic mean production of hot metal over the baseline period;
$CLEF_{hot\ metal,k}$	the applicable Carbon Leakage Exposure Factor for the hot metal sub-installation in year $k$ ;
$BM_{coke}$	XXX allowances/t coke;
$HAL_{coke}$	the arithmetic mean production of coke over the baseline period;
$CLEF_{coke,k}$	the applicable Carbon Leakage Exposure Factor for the coke sub-installation in year $k$ ;
$Em_{COGfl}$	the annual amount of emissions from flared COG during the second baseline period (expressed in tCO <sub>2</sub> /yr);
$V_{COGfl}$	the volume of COG flared for reasons other than safety flaring (expressed in Nm <sup>3</sup> or tonnes);
$NCV_{COG}$	the Net Calorific Value of the COG (expressed in TJ/Nm <sup>3</sup> or TJ/t);
$EF_{COG}$	the emission factor of the COG (expressed in tCO <sub>2</sub> /TJ).

The preliminary allocation to plant A relating to its heat consumption (including heat produced from the waste gases) will be the following, assuming that plant A produces heat for the production of non-benchmarked products or for export to non-ETS consumers:

$$F_{A,k} = BM_{heat} \times HAL_{heat} \times CLEF_{A,k}$$

Where:

$F_{A,k}$	the annual preliminary allocation for installation A in year $k$ (expressed in EUAs/year);
$BM_{heat}$	XX allowances/TJ;
$HAL_{heat}$	the arithmetic mean heat consumption of plant A over the baseline period expressed in TJ;
$CLEF_{A,k}$	the applicable Carbon Leakage Exposure Factor for the product produced in installation A with the imported heat, in year $k$ .

There will be no free allocation for the power plant.

### 5.3 Example 3 – allocation in the case of a non-benchmarked product

In this example, a chemical plant not covered by a product benchmark:

- Uses part of its waste gases to produce electricity on-site;
- Sells part of its waste gases to another installation covered by the EU ETS (plant B) for heat production;
- Flares the remaining waste gases.

The above situation is illustrated in Figure 16.



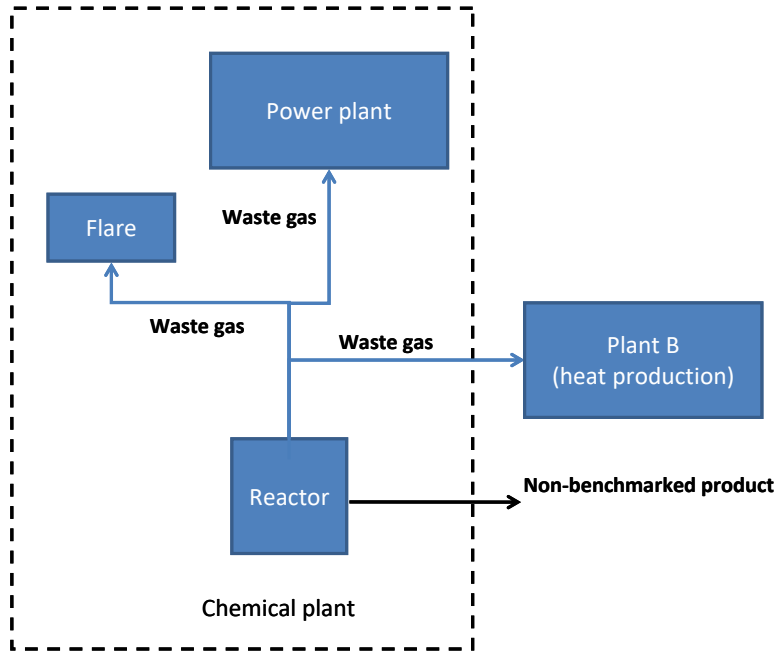

**Figure 16** Example 3 – Waste gases produced outside the boundaries of a product benchmark

In this case, attention has to be paid to ensure that the allocation for the production of the waste gas is split between the chemical plant (that uses its own waste gas) and the external user of the waste gas (plant B).

The preliminary allocation to the chemical plant relating to the waste gas production will be the following, taking into account all non-flared waste gas, regardless of whether it is used for direct or indirect heating, or for electricity production:

$$F_{i,k} = 0.97 \times \text{Arithmetic mean}_{\text{BaselinePeriod}} [V_{\text{WG, chem. plant}} \times \text{NCV}_{\text{WG}} \times (EF_{\text{WG}} - EF_{\text{NG}} \times \text{Corr}_{\eta})] \times \text{CLEF}_{i,k}$$

Where:

- $F_{i,k}$  the annual preliminary allocation for sub-installation  $i$  in year  $k$  (expressed in EUAs/year)
- $V_{\text{WG, chem. plant}}$  the non-flared volume of waste gas in  $\text{Nm}^3$  or tonnes used internally in the chemical plant;
- $\text{NCV}_{\text{WG}}$  the Net Calorific Value of the waste gas in  $\text{TJ}/\text{Nm}^3$  or  $\text{TJ}/\text{t}$ ;
- $EF_{\text{WG}}$  the emission factor of the waste gas in  $\text{tCO}_2/\text{TJ}$ ;
- $EF_{\text{NG}}$  the emission factor of natural gas (=  $56.1 \text{ tCO}_2/\text{TJ}$ );
- $\text{Corr}_{\eta}$  a factor that accounts for the difference in efficiencies between the use of waste gas and the use of the reference fuel natural gas;
- $\text{CLEF}_{i,k}$  the applicable Carbon Leakage Exposure Factor for the sub-installation  $i$  in year  $k$ .

The chemical plant will get no free allocation for the use of waste gases for electricity production, nor any allocation for the flared waste gases, except if they are flared for safety reasons. In case of safety flaring, an additional allocation will be given to the chemical plant, which will be included in its fuel benchmark sub-installation (*not presented here*).

The preliminary allocation to plant B<sup>8</sup> (external waste gas consumer) relating to the waste gas production will be the following, taking into account all non-flared waste gas, regardless of whether it is used for direct or indirect heating, or for electricity production:

$$F_{B,WG,k} = 0.97 \times \text{Arithmetic mean}_{\text{BaselinePeriod}} [V_{WG, \text{plant B}} \times NCV_{WG} \times (EF_{WG} - EF_{NG} \times \text{Corr}_\eta)] \times CLEF_{B,k}$$

Where:

- $F_{B,WG,k}$  the annual preliminary allocation for plant B for the producer part of the waste gases in year k (expressed in EUAs/year);
- $V_{WG, \text{plant B}}$  the non-flared volume of waste gas in Nm<sup>3</sup> or tonnes used in plant B;
- $NCV_{WG}$  the Net Calorific Value of the waste gas in TJ/Nm<sup>3</sup> or TJ/t;
- $EF_{WG}$  the emission factor of the waste gas in tCO<sub>2</sub>/TJ;
- $EF_{NG}$  is the emission factor of natural gas (= 56.1 tCO<sub>2</sub>/TJ);
- $\text{Corr}_\eta$  a factor that accounts for the difference in efficiencies between the use of waste gas and the use of the reference fuel natural gas;
- $CLEF_{B,k}$  the applicable Carbon Leakage Exposure Factor for the product produced by plant B, in year k.

In addition to this part of the allocation for the production of the waste gas, plant B will also get allocation for the heat produced based on the combustion of the waste gases (and possibly other fuels, not presented in the figure). The preliminary allocation to plant B relating to its heat consumption (including heat produced from the waste gases) will be the following:

$$F_{B,H,k} = BM_{\text{heat}} \times HAL_{B,H} \times CLEF_{B,k}$$

Where:

- $F_{B,H,k}$  the annual preliminary allocation for plant B for the consumer part of the waste gases (based on the heat benchmark) in year k (expressed in EUAs/year);
- $BM_{\text{heat}}$  **XX** allowances/TJ;
- $HAL_{B,H}$  the arithmetic mean heat consumption of plant B for the measurable heat produced from the waste gases over the baseline period and consumed on-site or exported;
- $CLEF_{B,k}$  the applicable Carbon Leakage Exposure Factor for the product produced by plant B, in year k.

---

<sup>8</sup> In this example, plant B is covered by the EU ETS. If that were not the case, then there would be no free allocation for this part of the waste gas production.

## Annex A: Comparison with 2011 Guidance Document 8

The below table shows how the sections of the 2011 version of Guidance Document 8 correlate to the sections in the current, 2019 version, and where main topics are covered. Please note that the contents of corresponding sections in the different versions can be significantly changed as a result of new rules in the revised ETS Directive or the FAR regulation. ‘-’ indicates that the topic was not included in the corresponding GD.

Content	Section in		Comments
	2011 GD8	2019 GD8	
Introduction	1	-, in GD1	2019 GD8 refers to general introduction section in 2019 GD1
Status of the Guidance Documents	1.1	-, in GD1	
Background of the CIM Guidance Documents	1.2	-, in GD1	
Use of the Guidance documents	1.3	-, in GD1	
Additional guidance	1.4	-, in GD1	
Scope of this guidance document	1.5	1	
Definitions	2	2	
Articles relating to waste gases in the CIMS/FAR and in the Directive	1.5	2.1	Moved from introduction to definition section. References to recitals removed, and references to articles in Directive added.
Definition of waste gases	-	2.2	Definitions updated in line with changes in legislation. The flaring provision for waste gases included in a product benchmark, applying as of 2026 has been added as well as some thresholds to help clarify the definitions.
Background to waste gases in specific industries	3	3	
Iron and Steel and other metals industry	3.1	3.1	
Chemical industry	3.2	3.2	The example at the end of the section has been reworded.
Allocation / Calculation of Activity Levels and	4	4	Figure 3, aiming at a clarification of parts “P” and “C” of the

allocation			emissions relating to waste gases and additional explanation added.
Allocation relating to the production of the waste gas	4.1	4.1	Equation for new flaring provision added, and equations adapted for consistency with other GDs.
Allocation relating to the consumption of the waste gas	4.2	4.2	
Total allocation for production and consumption of waste gases	4.3	4.3	
Summary of allocation methodologies in case of waste gases	4.4	4.4	The table has been updated
Case studies	5	5	
Example 1 – defining sub-installations linked to waste gases	5.1	5.1	Reflects the impact of the new flaring provision
Example 2 – allocation in the case of a benchmarked product	5.2	5.2	Reflects the impact of the new flaring provision has been taken into account.
Example 3 – allocation in the case of a non-benchmarked product	5.3	5.3	