

Final Report  
on

## **Establishing the Leakage Rates of Mobile Air Conditioners**

(B4-3040/2002/337136/MAR/C1)

Prepared for the  
European Commission (DG Environment)

by

Winfried Schwarz (Öko-Recherche) & Jochen Harnisch (Ecofys)

Contact:

Öko-Recherche GmbH  
Winfried Schwarz  
Kaiserstr. 61  
60329 Frankfurt  
Germany  
phone: +49 69 25 23 05  
[ws@oekorecherche.de](mailto:ws@oekorecherche.de)

17. April 2003



## **CONTENT**

### **SUMMARY**

|                                                                                                    |           |
|----------------------------------------------------------------------------------------------------|-----------|
| <b>I. INTRODUCTION: HOW ESTABLISH THE LEAKAGE RATE OF MOBILE AIR CONDITIONING SYSTEMS?</b>         | <b>1</b>  |
| I. 1 Five types of emissions                                                                       | 2         |
| I. 2 Specifics of the used approach                                                                | 4         |
| I. 3 Refinement of the method in cooperation with Contact Group                                    | 4         |
| <b>II. MEASUREMENT ACCURACY</b>                                                                    | <b>6</b>  |
| II.1 How accurate can the extracted refrigerant be measured?                                       | 6         |
| II.2 How much refrigerant remains un-recovered in the MAC?                                         | 8         |
| II.2.1 The first qualification test with six brand new cars                                        | 9         |
| II.2.2 The second test with two cars where the fill was known                                      | 11        |
| II.3 Is the carmaker's norm service fill identical with the first fill at the assembly plant?      | 12        |
| II.4. What is the suitable starting point to determine the age of a car?                           | 13        |
| II.5 What is the impact of previous topping-up a MAC, if it remains undetected at the measurement? | 14        |
| <b>III. COMPOSITION AND REPRESENTATIVITY OF THE SAMPLE</b>                                         | <b>15</b> |
| III. 1. Climatic and national composition                                                          | 15        |
| III. 2. Make composition                                                                           | 16        |
| III.3 Age composition                                                                              | 20        |
| III. 4 Summary                                                                                     | 22        |
| <b>IV. ELIMINATION OF OUTLIERS FROM THE SAMPLE</b>                                                 | <b>23</b> |
| IV.1 Removal of too old or too young MACs                                                          | 24        |
| IV.1.1 Elimination of 18 MACs older than seven years                                               | 24        |
| IV.1.2. Removal of two overcharged MACs                                                            | 24        |
| IV.1.3 Elimination of 4 MACs younger than one year                                                 | 25        |
| IV.2 The correction of the measuring differences by 20 grams                                       | 25        |
| <b>V. THE RESULTS: ANNUAL REGULAR LEAKAGE RATE OF MACS IN EU-15</b>                                | <b>27</b> |
| V.1 The average leakage rate per year in grams and percent                                         | 27        |
| V.2 The scattered profile of the individual annual leakage rates                                   | 28        |

|                                                                            |           |
|----------------------------------------------------------------------------|-----------|
| <b>V.3 Age dependency of the leakage rates</b>                             | <b>29</b> |
| <b>V.4 Average annual leakage rates by countries</b>                       | <b>31</b> |
| <b>V.5 Average annual leakage rates by car make</b>                        | <b>32</b> |
| <b>V.6 Average annual leakage rates by MAC properties</b>                  | <b>33</b> |
| <b>V.7 Average annual leakage rates by selected vehicle properties</b>     | <b>34</b> |
| <b>V.8 Average annual leakage rates by selected measurement conditions</b> | <b>35</b> |
| <b>V.9 Weighting the averages with car make and age</b>                    | <b>36</b> |
| <b>V.10 Conclusions</b>                                                    | <b>39</b> |

## **ANNEX I MEASUREMENT PROTOCOL**

## **ANNEX II PARTICIPATING GARAGES**

## **ACKNOWLEDGEMENTS**

## **LITERATURE**

## Summary

The purpose of the study is to - based on field measurements - determine the average annual leakage rate of HFC-134a from MACs in the European Union of a "second generation"<sup>1</sup> air conditioner.

From November 2002, to January 2003 300 measurements of HFC-134a leakage were carried out on air conditioners of cars up to seven years age. The measurements were carried out on vehicles of all EU relevant makes at 19 garages in Germany (Osnabrück), Portugal (Rio Maior) and Sweden (Helsingborg) reflecting different climatic conditions. Prior to these measurements 140 vehicles had been tested in a separate project funded by the Dutch Energy and Environment Agency (NOVEM) in October 2002. These measurements helped to test and refine the methodology.

Industrial experts from car manufacturers and component suppliers played a key role in the Contact Group that was established for this exercise by DG Environment of the European Commission. These experts helped to solve many important questions relating to measurement accuracy. The Contact Group helped in defining a measurement protocol to ensure the accuracy of measurements.

This study focused entirely on "regular leakage", which takes place gradually from undamaged, functioning air conditioners. This is quite different to the "irregular emissions", attributable to system failures caused by internal and external reasons, mostly by accidents or stone impacts. Irregular emissions mainly result in total refrigerant loss, which is noticed by the driver and usually leads to a repair.

The main results of the study are:

1. Based on the measurements, the EU wide average (un-weighted) leakage rate is estimated to be 52.4 grams per year. This equals 6.9% per year. If the leakage rates are weighted to reflect the vehicle composition in the EU, the leakage rate was estimated at 53.0 grams per year. Weighting the leakage rates by the age of the vehicle, the weighted average leakage rate was estimated at 53.9 grams per annum.
2. There was a wide distribution of leakage among different vehicles makes ranging from 28.8 grams (or 5.3%) to 81.9 grams (10.6 %) per year. Perhaps unexpectedly, the leakage rate was found to be higher for cars that were under 2 years of age. As it is unlikely that the air conditioning design or the components of the air condition system have suddenly deteriorated in 2001-02, this issue warrants further investigation.
3. Climatic conditions seem not to influence much the leakage rate. There was some evidence supporting the hypothesis that the more the air conditioner prone to corrosion due to winter conditions the higher the leakage rate, as the leakage rate found in Sweden (54.3 grams or 7.0% per year) was higher than in Germany (48.7 grams or 6.2% per annum). However, it also seemed that the more the air

---

<sup>1</sup> By „second generation“ implies that the teething problems of the „first generation“ HFC based air conditioners have been sorted out. According to experts this took place in the EU in 1996-7.

conditioner is operated the higher the leakage rate, as the leakage rate of air conditioners measured in Portugal (54.0 grams or 7.5% per year) were higher than in Germany (48.7 grams or 6.2% per annum). All in all the differences were fairly small.

4. Smaller charged MACs (mean fill 684 g) were found to have a smaller leakage both in absolute (44.2 grams per year) and relative (6.5% per year) terms. Larger sized MACs (mean fill 883 g) had an annual leakage rate of 66.9 grams or 7.7% per year.

The main finding of this study is that the annual weighted<sup>2</sup> average “regular” leakage rate for a “second generation” mobile air conditioners is 53.0 grams per annum. This needs to be compared with the other HFC-134a emissions that occur during the lifetime of the air conditioner. These emissions are (i) before taking the car into use, (ii) “irregular” emissions due to accidents, stone hits, component failures, (iii) emissions during service and (iv) emissions at the end of life of the vehicle. In another study (Öko-Recherche 2001) it was estimated that the “irregular” losses were about 16.3 grams per annum. Adding the regular and irregular emissions and assuming that the expected lifetime of a vehicle is 14 years, the expected greenhouse gas emission from a mobile air conditioner of an average in the EU is about 1,3 tonnes<sup>3</sup> of CO<sub>2</sub> equivalent.

To understand the full climatic impact of the mobile air conditioner, the lifetime emissions of about 1,3 t CO<sub>2</sub> eq. need to be complemented by HFC-134a emissions before the vehicle has been taken into use, the service emissions and the end-of-life emissions, as well as CO<sub>2</sub> emissions due to the increased fuel consumption as a consequence of operating the air conditioner.

---

<sup>2</sup> The European car fleet with mobile air conditioner was used as the weight in order to correct the over and under representation of some makes in the sample of measured air conditioner.

<sup>3</sup>  $(53+16.3)*14*0.013=1.3$

## I. Introduction: How establish the leakage rate of mobile air conditioning systems?

Mobile air conditioning (MAC) in passenger and utility vehicles contribute to EU greenhouse gas emissions through emissions of the hydrofluorocarbon (HFC) refrigerant HFC-134a and through increases of fuel consumption of vehicles equipped with MAC. These emissions are currently on a rapid rise due to a growing penetration rate of MAC within the European vehicle fleet. Figure 1 illustrates how emissions of fluorinated greenhouse gases are projected to grow from 1995 to 2010. While total emissions of HFCs are expected to double over this period (from roughly 1% to 2% of EU greenhouse gas emissions), the contribution of MAC related HFC emissions is likely to grow by more than a factor of 10. This growth from MAC related HFC emissions corresponds to the reduction commitments (2010 vs. 1990) which the Netherlands or Denmark have under the EU burden sharing agreement for the Kyoto protocol or 5% of the entire EU reduction commitment.

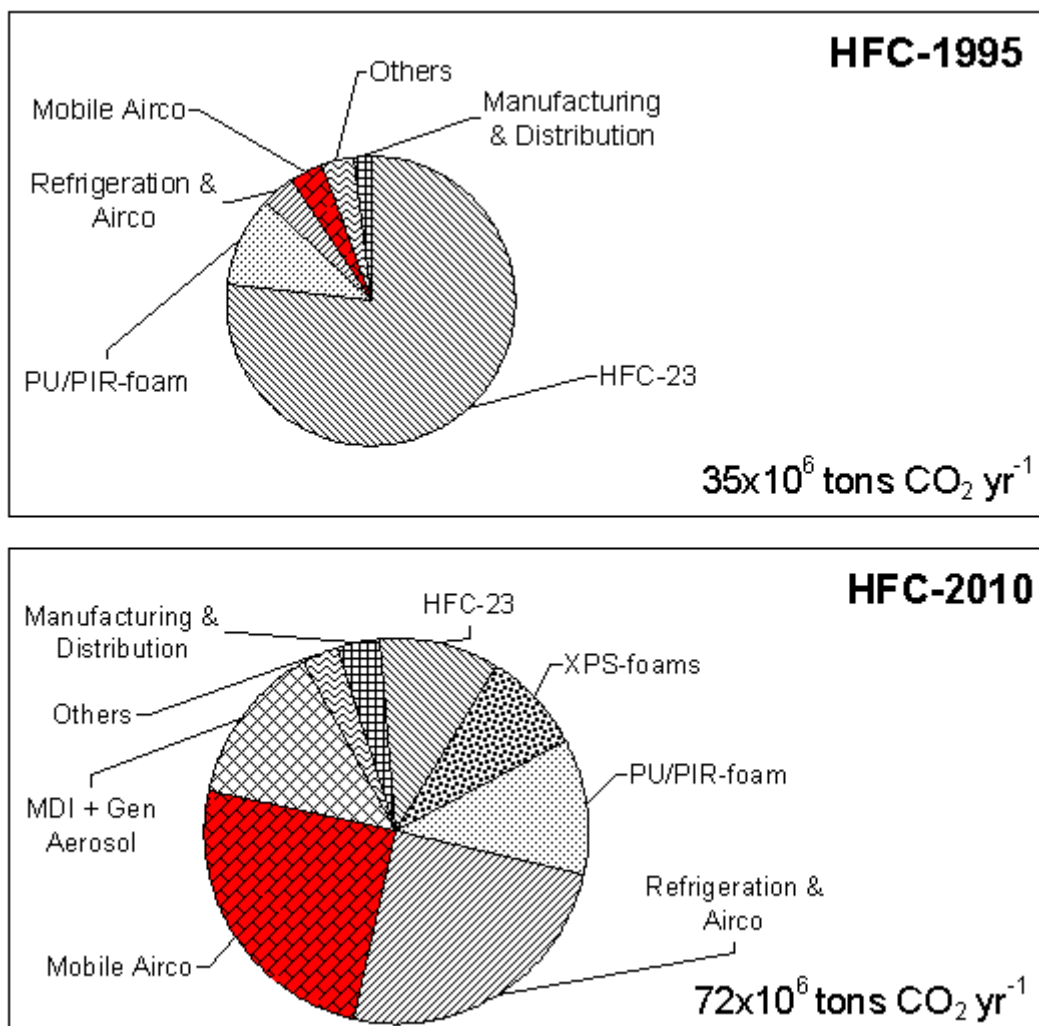

**Figure 1: Projected evolution of emissions from different sources of HFCs between 1995 and 2010. Red segments: Emissions from MACs. Source: ECOFYS [2000].**

It is, however, important to note that large uncertainties are connected to these estimates. In the past applied emission estimates were generally based on laboratory

measurements and expert solicitations (see selected special literature at the end of this study). Representative field measurements have not yet been carried out.

This study aims to fill this knowledge gap regarding leakage rates of mobile air conditioners in Europe. It was expected that regular leakage rates vary by age of the system, its specific usage pattern, respective climate conditions and product design. The effects of system failures (called “irregular losses”) due to internal and external causes also need to be taken into account. The same applies to emissions occurring at the end-of-life vehicles. This study did not try to estimate the “irregular” emissions or end-of-life vehicle emissions but focussed solely on the “regular” emissions.

This purpose of this study is to enable the European Commission to know current emission levels with reasonable accuracy and enable it to make empirically based projections of emission levels up to 2020 if no additional policies and measures are undertaken.

### I. 1 Five types of emissions

Five different categories of HFCs-emissions are to be distinguished: emissions before the registration of the vehicle, **regular** (gradual or steady loss), **irregular** (sporadic loss due to system failure), emissions during service and **end-of-life** (EOL) emissions (occurring when a vehicle is dismantled).

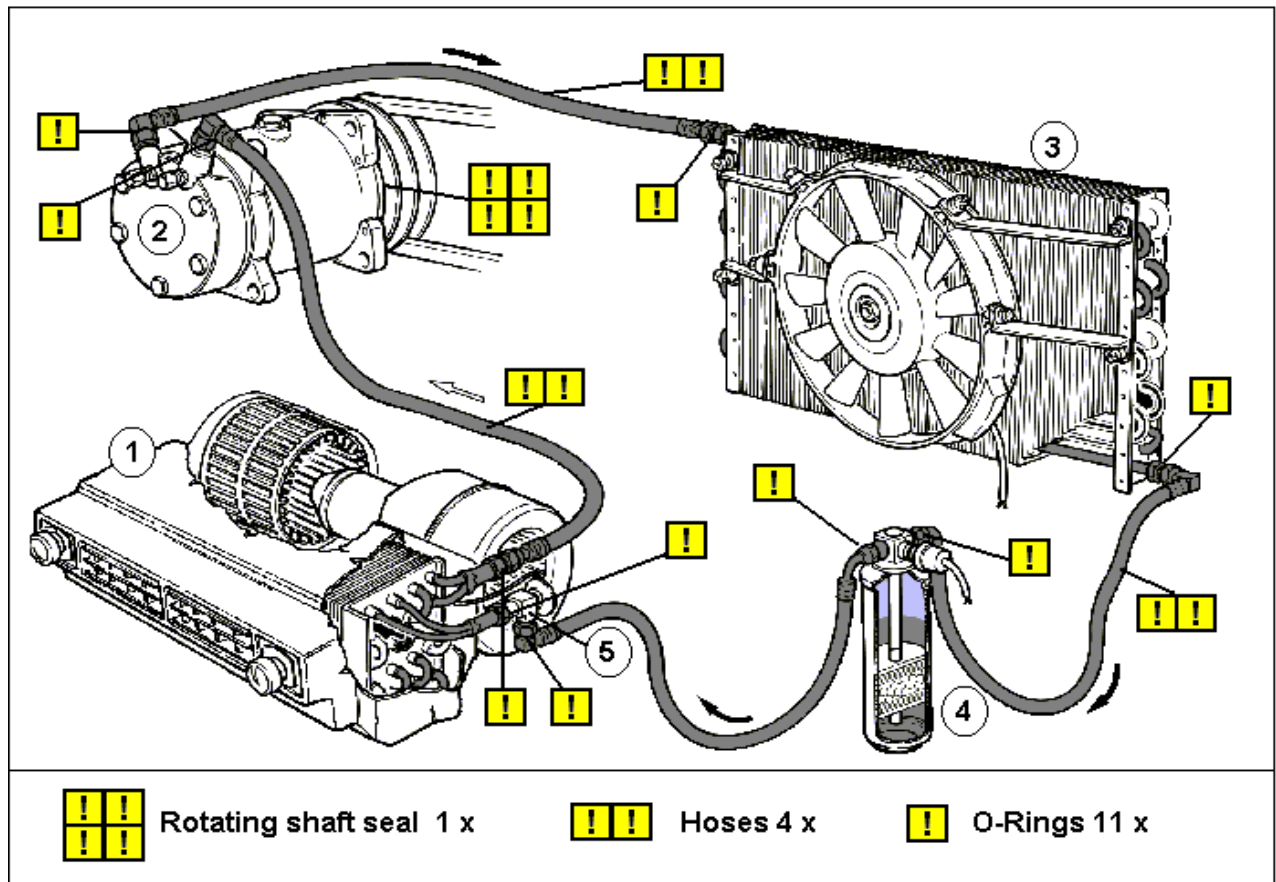

Figure 2: MAC and its weak spots leading to a gradual steady loss of HFC-134a in a range tolerated by car manufacturers (over 15 grams/yr.) The refrigerant circuit: 1 = Evaporator. 2 = Compressor. 3 = Condenser. 4 = Receiver/Drier. 5. Expansion valve.



**Emissions before the assembly of the vehicle:**

These emissions are likely to be small and relate to the manufacturing and transport of the refrigerant, and the losses during the filling of the MAC.

**Regular emissions:**

Unlike stationary refrigeration and air conditioning, the refrigerant circuit in MAC systems for road vehicles is unstable due to the specific conditions in a vehicle leading to certain levels of unavoidable losses of refrigerant.

First, the compressor is driven by the engine and inevitably not hermetically closed. Second, all components and connecting lines are exposed to the vibrations of the engine and the heat developed by it. In addition, the pressure inside the A/C system is permanently high, not only in the running times of the engine (200-800 h/yr) or of the A/C unit (ca. 100-400 h/yr) but during the whole life time of the system. Losses of gaseous refrigerant are "regular" and generally accepted by car manufacturers within certain specified limits (see Figure 2). Up to a certain level (e.g. 50%) cumulative losses do not considerably reduce the cooling performance of the system and thus generally remain unnoticed by the driver.

**Irregular emissions:**

So-called irregular emissions occur during the use phase of the vehicle in addition to the regular emissions taking place. The term refers to emissions connected to system failures caused by internal and external reasons. Most often irregular emissions will occur as a result of major or minor accidents or minor impacts of stones and alike. The condenser which is generally located at a fairly exposed place in the front of the engine is affected most often by these events. These damages generally lead to a loss of the remaining charge within a short time. The MAC system then provides no longer cool air and needs to be repaired.

**Service emissions:**

Service emissions take place during the service of the MAC system. These losses can be large if the service staff do not follow proper procedures and do not use the appropriate recycling and recovery equipment of the refrigerant (HFC-134a).

**End-of-Life emissions:**

Disposal emissions at the end-of-life (EOL) of the vehicle also need to be considered to the extent to which remaining MAC system charge is not recovered. The specific emissions depend on whether the scrapping company is equipped with recovery equipment or not, the technical performance of the system, whether the system is applied at all and with which level of skill and care. The ELV Directive (Directive 2000/53/EC of the European Parliament and of the Council of 18 September 2000 on End-of-Life Vehicles) requires the recovery of all fluids from old cars before scrapping. National implementation and enforcement should thus ensure that EOL emissions within the EU will be close to a technical minimum. However, it needs to be taken into account that a large fraction of used EU-cars is exported to other regions where often no recovery of fluids will take place at EOL.

## **I. 2 Specifics of the used approach**

This study focused on regular emission during the use-phase.

To estimate **regular** emissions, one needs to measure with special instruments the remaining HFC filling of a representative sample of vehicles with **undamaged** air conditioning systems. A questionnaire needs to contain information on age, mileage, vehicle type, last refill and alike<sup>4</sup>.

For the design of the study the following two specifications were fundamental:

1. The leakage rate is defined as grams of HFC-134a that have leaked on the average in one year from a car with a MAC.
2. The objective was to have leakage rates of MACs established for the European passenger fleet. To the extent possible, the leakage rates need to be age, climatic region and product dependent.

## **I. 3 Refinement of the method in cooperation with Contact Group**

Industrial experts from car manufacturers and component suppliers played a key role during the course of the entire project, i.e. all three main phases of the study, the preparation, the measurements themselves and their analysis. Most of the experts were represented in the Contact Group. They identified and helped solve a number of important questions on the extraction procedure, the measuring equipment and its accuracy.

During the first phase of the work within the project (June to September 2002) mainly the content of the measurement protocol and the suitability of different types of measurement equipment were discussed. These concerted efforts led to the adoption of completely revised approach and protocol. The underlying deliberations are put down in chapter II of this report. The measurement protocol can be found in the annex to this report.

Based on these insights greatest emphasis within the study was based on the empirical part: between November 2002 and January 2003 a set of 300 measurements was carried out in 19 different used car dealerships in three EU countries with distinctly different climates (Sweden, Germany and Portugal) in order to establish a reliable value for regular HFC-emissions from the EU car fleet.

It also needs to be noted that the Dutch Energy and Environment Agency (NOVEM) co-sponsored the field work within this project. An additional 140 measurements on

---

<sup>4</sup> To estimate **irregular** emissions on the other hand no specific measurements will be undertaken. Instead the relevant information on cases of defect systems must be collected from garages by means of interviews. For this purpose a special questionnaire should contain information e.g. on the total amount of HFC used for the re-filling of damaged MAC-systems, the share of air conditioned vehicles within the total fleet of vehicles coming for service and inspection, and on system parts which were affected most frequently.

## *I. How to establish the leakage rate?*

used vehicles re-imported from a number of EU countries could thus be carried out in Germany before the 300 measurements made under this study.

This report is structured as follows: Chapter II of this report addresses accuracy issues of the measurement equipment and the overall approach. Chapter III deals with the selection criteria of vehicles for a representative sample in respect to makes, age, countries while in Chapter IV correction and rejection criteria are described to eliminate biases and outliers. The concluding Chapter V presents the results of the analysis of the measured data.

An age of "0" year means younger than one year ( $<1$ ), i.e. the time from first registration until the end of the 11<sup>th</sup> month since that date. Consequently "1" means the time from the 12<sup>th</sup> to the 23<sup>rd</sup> month, when the car is one year old but not yet two, and so on.

## **II. Measurement accuracy**

One key challenge within this project was to establish satisfactory accuracy using automatic recovery stations to measure how much refrigerant was left in undamaged air conditioners.

The charge extracted and weighed was compared to the norm fill and difference (loss) needed to be distributed over the car's age to obtain a time-related (annual) leakage rate.

From the very beginning of the project every effort was made to ensure that the measurements were made as accurate as possible. Due to the importance of this task, a lot care was devoted to plan and test the appropriate measurement protocol. There were five main issues, which were highlighted by the MAC experts of the Contact Group:

1. How accurately can the weight of the recovered refrigerant be determined, given a successful refrigerant transfer from a MAC into a recovery station?
2. How much of the MAC's refrigerant charge can be extracted and how much remains un-recovered?
3. Is the carmaker's norm service fill (specified by a label on the vehicle) identical with the first fill at the assembly plant?
4. After determining the difference between norm charge and actual charge, this loss must be put in relation to the car's age to achieve an annualized leakage rate. What is the suitable starting point to determine the age of a car? Is it the date of assembly or first registration?
5. What is the impact of previous topping-up a MAC, if it remains undetected at the measurement?

These issues were solved with the help of the experts of the Contact Group as described below.

### **II.1 How accurate can the extracted refrigerant be measured?**

Every recovery station works according to the same process. The only propelling force transporting the refrigerant throughout the recovery operation is the compressor in the recovery station. Not only does the compressor suck the refrigerant out of the air-conditioning system and force it into the condenser, but it also is the only agent causing the refrigerant already disposed in the liquids pipeline (downstream of the condenser) to flow on into the reservoir tank. From there the liquid continues to flow out of the condenser thanks to the workings of the compressor. As soon as this flow peters out (once the system is sucked empty), the refrigerant remains stationary in the final stretch in the condenser and between condenser and collecting vessel.

At the First Contact Group Meeting (on 28. 06 2002) MAC experts expressed concern whether it was possible to achieve meaningful accuracy by using recovery stations. The concern was that an important amount of the refrigerant sucked into the

device would not reach the reservoir tank on the built-in scales. Built-in scales displaying digitally the changes in the tank's weight are state of the art for modern recovery stations.

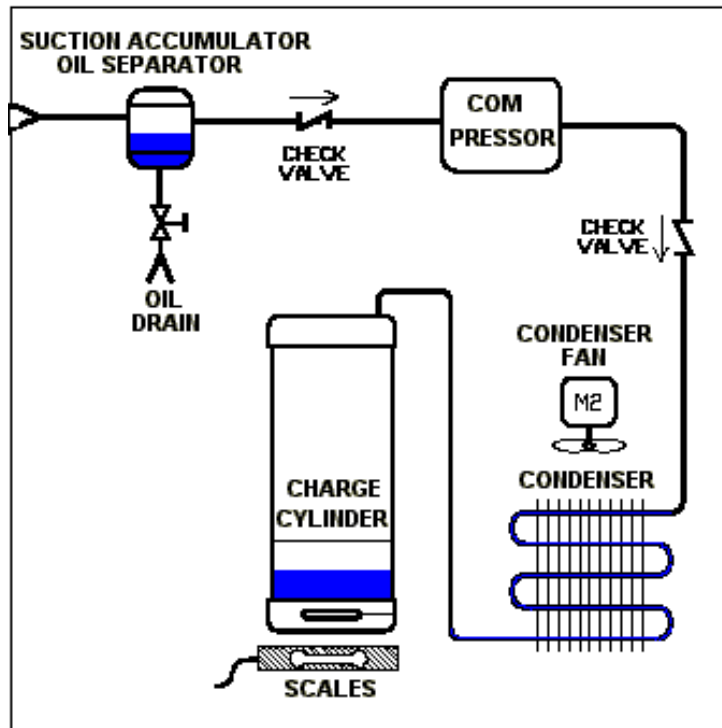

The flow chart on the left shows the way of the refrigerant (blue) into a recovery station. First it flows through the suction accumulator/dryer, where a refrigerant fraction might be held back, thus not even reaching the compressor. A part of the refrigerant may remain in the compressor itself and anywhere in the internal piping system. A considerable source of distortion is possible because of liquid-gaseous mass shifts in the condenser and between condenser and tank (charge cylinder), depending on temperature and pressures. Finally, vibrations of the running condenser fan may falsify the weighing.

**Figure 3: The inside of a recovery station.**

These are the main reasons why it cannot be taken for granted that the increment in the tank's weight exactly equals the refrigerant quantity sucked into the station.

The first attempt to check the weighing accuracy was made in Emsdetten, at Waeco, the German leading independent aftermarket company not only supplying AC systems and refrigerant but also several types of recovery stations.



The Waeco experts (Mr Esch, Mr Pott) used a modified automatic (and optionally manual) service station Waeco RHS 780/1 (OEM: RTI Technologies Inc, York, PA, USA). As opposed to most other service stations, in this station the condenser forms one unit with the refrigerant tank on the load platform. Thus, the weighing is not distorted by shifts between gaseous and liquid refrigerant within the condenser.

Moreover, Waeco technician modified the Waeco RHS 780/1. He separated mechanically the condenser fan from the condenser to prevent the fan's vibrations influencing the weighing process.

**Figure 4: The recovery station "RHS 780/1", as used at the Emsdetten qualification test, avoids two of the possible sources of error inside the station (liquid-gaseous shifts and fan vibrations).**

The tests carried out with this slightly modified commercially available recovery station showed in fact higher recovery efficiency than usual systems tested beforehand. Of a defined refrigerant quantity filled into an evacuated MAC (420 grams) the station could recover 400 grams, leaving a residue of 20 grams.

Even in such an adjusted recovery station (with disconnected condenser fan, and united weighing both condenser and bottle) certain parts of refrigerant still could be held back in the piping, the dryer or the compressor. Therefore the Waeco experts proposed a different solution. This was applied in the actual field measurements in Germany, Portugal and Sweden.

The essential feature of the solution is the use of external scales with high resolution (10-gram-intervals). The whole recovery station was loaded on a scale before and after each suction operation. By using an external scale the refrigerant distribution within the recovery station would no longer matter.

Additional advantages of applying an external scale (instead of modifying recovery stations) are (1) the higher degree of reproducibility due to the high accuracy of the external scales compared with the effect of mechanical manipulations inside a recovery station, (2) the possibility to use simple recovery stations without built-in scales, and (3) the possibility to utilize the long phase of automatic recovery for connecting one or two more commercial recovery stations to MACs simultaneously. In this way one technician could double the number of measurements he carried out per day.

Finally, some oil could be left in the refrigerant during the suction extraction. This oil may be collected in the station's oil-separator. In order to measure the amount of refrigerant recovered accurately, this oil was drained off after every recovery cycle.

Details on how to operate simple and technically unmodified recovery stations together with external scales for measuring purposes can be found in the "Measurement Protocol" at the Annex I of this report.

## **II.2 How much refrigerant remains un-recovered in the MAC?**

The experts of the Contact Group questioned to which extent a recovery of refrigerant from the MAC was possible without taking apart the MAC system itself. They suspected that a large refrigerant fraction (up to 100 grams and more) could remain un-recoverably solved in the oil or in deeper parts of the refrigeration circuit, e.g. in the relatively big accumulator (when an orifice tube serves as expansion device) or even in the receiver (installed when expansion valves are used for refrigerant injection into the evaporator).

At one of the qualification tests – still carried out with a technically unmodified recovery station and not yet using external scales – 60 grams had been indicated as not recovered. From 470 grams filled in a previously emptied MAC (evacuation time 30 minutes at below 5 mbar) only 410 grams was recovered. Although both the filling charge and the recovery were weighed with built-in scales not providing the same

weighing accuracy as external scales, the conclusion was clear. Under certain circumstances the recovery was insufficient.

In this case the special circumstance had been a "warming up" of the MAC as a trial to provide a more uniform refrigerant distribution inside (engine turned on and set to 2,000 rpm for 15 minutes). The warming up intended to drive out more refrigerant from the oil it was dissolved in. But it turned out to have the opposite effect. Obviously the heat and the vibrations of the engine did not loosen the refrigerant but intensified the mixing of oil and refrigerant. This experience led to the specification in the measurement protocol that all cars being measured, needed a resting time of at least 24 hours before recovery.

The Waeco technicians told that a complete transfer from MAC to recovery station would be impossible. But based on their expert judgement they estimated that between 20 and 30 grams of refrigerant would remain in the MAC if the suction operation was conducted skill-fully, i.e. "softly" and "long" enough.

"Softly enough" was specified in terms of suction pressure, which should not fall below 0.7 bar absolute (-0.3 bar relative). "Long enough" was specified insofar as the recovery should take at least 15 minutes, and in the case of orifice tubes and big accumulators five minutes more<sup>5</sup>. Moreover, the ambient temperature should not be lower than 10 °C.

These specifications became together with the use of external scales main features of the measurement protocol (see Annex I). The measurement protocol guided all the 300 measurements of the this study as well as the preceding 140 control measurements funded by NOVEM .

### II.2.1 The first qualification test with six brand new cars

The location where the 140 NOVEM measurements were conducted is a used-car shop in North-West Germany, which is a large garage selling mainly one-year-old cars (ex-rental) coming from all over the EU.

On October 16<sup>th</sup>, 2002, the measuring expert of the project (the same expert carried out the 140 NOVEM funded measurements and the 300 measurements of this study) came across six of new Volkswagen Golf with mileage 0. These cars provided thus a possibility for a qualification test to see how much of a full MAC could be recovered, if the measuring equipment would operate in line with the measurement protocol.

---

<sup>5</sup> Although service emissions are out of the scope of this study, in this context a remark needs to be made. In the general hustle and bustle of everyday garage routine and under pressure at work, the ideal recovery conditions as outlined above are suspected to be rather the exception than the rule. As it is a fact that short and rapid recovery leaves a considerable amount of refrigerant in the MAC, it is also a fact that this residue will not stay there when servicing. As soon as the MAC is opened for repair the refrigerant is gradually escaping into the atmosphere, a process of releasing which gets completed eventually by the evacuation of all the residual gases as the obligatory last step before recharging. By that, service emissions of up to 50 grams can occur, and, if the garage technicians are not careful, the emissions can be even higher.. However, estimations of service emissions should consider the question how many MACs really need a workshop visit for servicing during their lifetime. Moreover, it must also asked how many of the MAC services are done with MACs being already completely empty when entering the shop.

The underlying, nevertheless plausible assumptions were, that (1) new cars would not have lost refrigerant and (2) the norm service charge on the vehicle's label (nameplate fill) was equal to the refrigerant quantity charged at the assembly plant. The latter was according to the Vehicle Identification Number (VIN) Wolfsburg with a distance from the garage of just 250 kilometres.

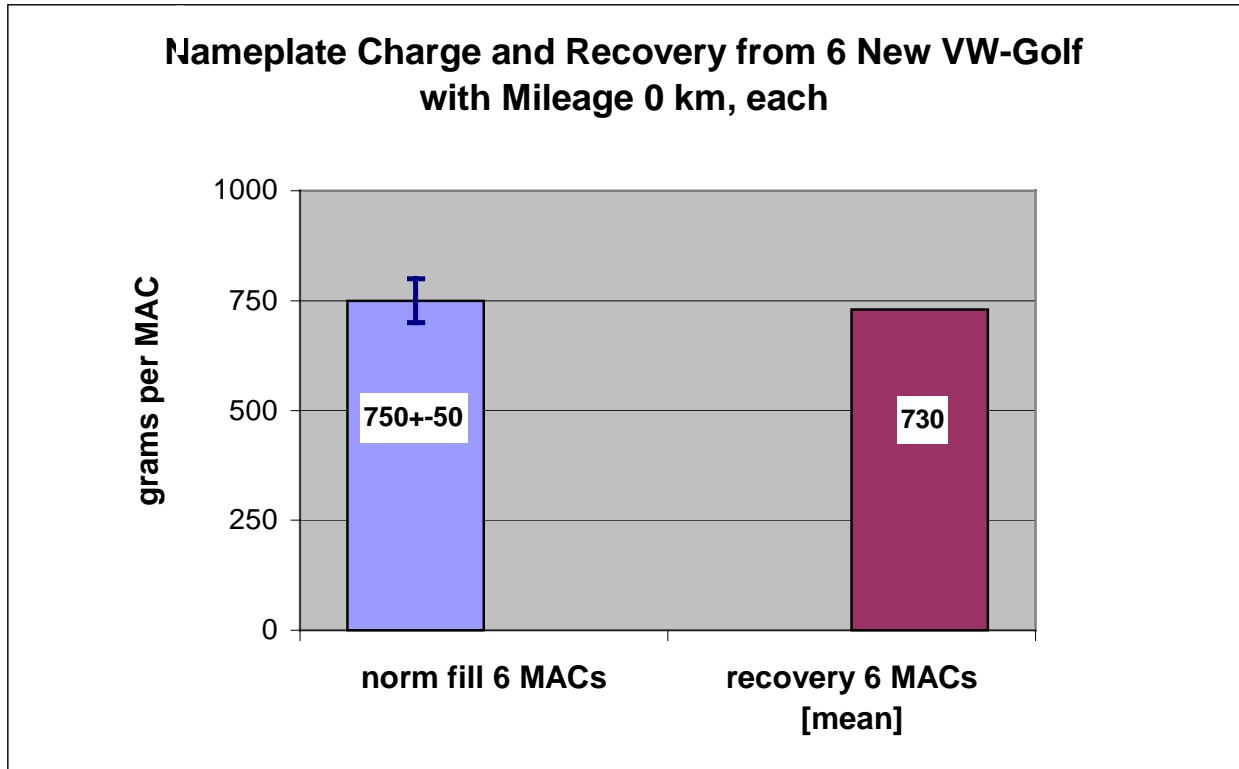

**Figure 5: Norm charge and recovery from 6 new VW-Golf with mileage 0 km, each. The left bar shows the full charge - with tolerance band, the right bar shows the mean recovery. The mean difference is 20 grams, meaning 20 grams unrecoverable by means of the measuring equipment used.**

The six vehicles were measured by means of the recovery stations Waeco RHS 650 and Waeco RHS 500. The ambient temperature was 17 °C. The average duration of a recovery cycle was 23.3 minutes.

From the norm charge of 750 grams (average of the indicated  $750 \pm 50$  grams) in two cases 720 grams, in three cases 730 grams, and in one even 750 grams were recovered and weighed. The differences against the norm charge were 2 x 30 grams, 3 x 20 grams, and 1 x 0 gram. The average difference amounted to 20 grams.

By decoding the VINs it turned out that the assembly of each of the six un-driven cars dated back 10 months (Dec 2001). That means that during the time between assembly and measurement date some refrigerant might have been lost, although not much. The test result of only 20 grams of refrigerant unrecoverable in the MAC gave confidence that the measurement protocol was rather accurate. All the following field measurements were conducted with the measurement protocol, bearing in mind that for later statistical analysis an average correction factor of plus 20 grams would be necessary to meet the real charges in the MACs measured. Otherwise the recovered charge would be understated and in that the difference to the norm fill (the loss) overstated.



### II.2.2 The second test with two cars where the fill was known

In March 2003, on invitation of the Volkswagen AG and its representative in the Contact Group Dr Adiprasito, a second control test was carried out at the Wolfsburg plant to check the accuracy of the measuring equipment used beforehand for the EC/NOVEM measurements. The question was how much refrigerant could be extracted out of two MACs with exactly defined refrigerant charges, following the measurement protocol? The test results confirmed that on the average 20 grams of refrigerant was left in the MACs if the measurement protocol was followed. (For details see box below.)

#### **Box 1: Description of the second control of the measurement protocol with two new cars, the fill of which was known exactly.**

On March 21, a Friday afternoon, one Polo and one Golf were prepared to be measured the following Monday. The time interval should be kept to meet the resting time of at least 24 hours prescribed by the measurement protocol. The Monday measurement should be done by the same expert and in the same way as at the preceding 440 field measurements.

The Polo 1.4 16 V had been assembled one year ago (13.03.2002) at the Pamplona plant. Its first registration dated back to almost the same time (15.04.2002). Its odometer showed 13.460 km. The Golf TDI was assembled just three weeks ago (25.02.2003) at the Wolfsburg plant itself and was not yet registered. Up to now the MACs of both vehicles had worked properly. Both MACs were controlled automatically ("Climatronic").

For the test, both MACs were completely emptied and evacuated. Ambient temperature was 22 °C. The recharging was not done by means of a recovery/recharging station, but directly from a refrigerant bottle through a thin plastic hose (diameter 2.8 mm) into the low-pressure service port downstream of the evaporator. Driving force to draw the refrigerant from bottle into MAC was the running compressor of the MAC itself - engine at idling condition. As opposed to filling by stations, the refrigerant thus flowing through the hose was constantly in gaseous state, in that minimizing the refrigerant weight in the hose (a potential source of error) down to zero.

The gaseous charging took a little more than 30 minutes for each MAC. It was stopped when the high precision scales (resolution of 0.1 gram), the bottle was placed on, indicated the required difference. The Polo was charged with 550 grams, the Golf with 750 grams. After charging the MACs, both vehicles were driven some kilometres with MAC turned on. Finally both vehicles were parked in the hall to rest untouched over the weekend.

On Monday the measuring expert Mr Borgert (M-tec) and Dr Schwarz (Öko-Recherche) started the measurements at 11.30 am by means of the recovery station Waeco RHS 650. Ambient temperature was 24 °C. First, the MAC of the Polo was recovered, and the external scales displayed an increase in the station's weight by 540 grams, from 70.34 kg to 70.88 kg, missing 10 grams of the full charge. The second recovery of the Golf's MAC increased the weight (which was left at 70.88 kg before renewed weighing) by 720 grams, increasing the displayed value to 71.60 kg thus missing 30 grams of the full charge.

Both measurements taken together<sup>6</sup>, 1.260 grams were recovered instead of 1.300 grams. The average recovery deficit per measurement was thus 20 grams.

<sup>6</sup> By adding up both recoveries the drawback of the relatively low 10-grams-resolution can be counteracted to a little degree. It should be kept in mind that behind 10 grams indicated the real weight can range from 6 to 14 g, in case of 30 grams the respective figures are 26 and 34 g.

The Wolfsburg test confirmed that with the measurement protocol on the average 20 grams of HFC-134a is not recovered from the MAC. Thus, for statistical analysis, this 20 grams of refrigerant needs to be taken into account.

### **II.3 Is the carmaker's norm service fill identical with the first fill at the assembly plant?**

During the course of this study 76 different car models were measured and 81 different indications of MAC charges were noted. These indications, mostly labelled on the vehicles themselves, specify the amount of refrigerant required for refilling after service. In two-thirds of the cases the specifications were not clear numbers like "800 grams" but rather specifications of certain tolerance range like "700 ± 50 grams" or "700 + 50 grams" or even "500 - 600 grams". Of course, in determining the refrigerant loss only the real level of the first fill at the assembly plant is of interest, not any service charging afterwards.

| <b>Table 1: Ways of indicating charges on vehicle labels, for frequencies in EC-300</b> |                              |                          |                            |
|-----------------------------------------------------------------------------------------|------------------------------|--------------------------|----------------------------|
| exact numbers<br>(e.g. 800)                                                             | up and down<br>(e.g. 700±50) | only up<br>(e.g. 700+50) | interval<br>(e.g. 500-600) |
| 102                                                                                     | 108                          | 70                       | 20                         |

Exclusively exact numbers (102 cases in total) were used by Opel, Mercedes-Benz, Volvo, Saab and Fiat. Up and down indications (108 cases in total) were typical for Renault, Ford, BMW, Peugeot, Citroen, SEAT, and partly VW. Audi used consistently "only-up" label, while VW used the "plus/minus"-indication as well. In the EC-300 sample the "interval" indications (20 cases in total) occurred only at Japanese makes.

Hence, the question was put to the carmakers' representatives in the Contact Group, what the connection was between the real charge a MAC is filled with at the plant, and the labelled charge of the MAC at the vehicle itself. Is there a uniform practice amongst the carmakers and if so, do they tend to a short or over charge, or do they charge the MACs up to a point between the extremes, possibly matching the average? In other words, does e.g. "700 ± 50" mean in terms of factory fill 650 grams or 750 grams or a figure in between, possibly 700 grams?

In the Contact Group meeting it was established – after a long discussion – that at least the European carmakers neither over nor under charge systematically their MACs. In other words, the indication on the label is to be taken as the nominal charge in the case of exact numbers or "x ± y". In cases of only upwards tolerances "x + y" the base number "x" should be used and in the case of a spread "x – y" the average ((x+y)/2) should be used.

In the Contact Group, a related question arose: How accurately do the plants' filling machines on the end of the assembly lines work? These machines are used to evacuate and charge a MAC within less than two minutes by means of so-called "filling-guns". The size of the charge itself can be pre-set and should be the same for each individual MAC.

By decoding the VINs for assembly plants it turned out that the cars of the sample of 300 cars came from 52 different European plants (including plants manufacturing

Japanese makes) and from 10 different over-seas plants. Assuming a uniform accuracy standard all over these plants, what is the usual deviation from the desired charge and is there a clear direction of the deviations (if there are any) upwards or downwards?

The experts amongst the car manufacturers and some special suppliers interviewed in the Contact Group said that deviations do exist, but that these remain within the range of at about one percent of the total fill. Further, they said that there is no clear direction (bias) in which the deviations tend. They rather oscillate around the fixed and pre-set quantity as their mean<sup>7</sup>.

The conclusion of these expert interviews was that in determining the refrigerant loss of a MAC (1) the average of the labelled charge can be used as benchmark and (2) that this benchmark needs no quantitative statistical correction. In sum, the experts of the Contact Group agreed that the nominal charge of the MAC should be taken as the starting point for calculating the leakage rate. According to the field tests of the measurement protocol, it was established that an average of 20 grams of HFC-134a needed to be deducted from this nominal charge, as this amount could not be evacuated with the measurement protocol.

#### **II.4. What is the suitable starting point to determine the age of a car?**

The choice of the adequate starting point could be a source of inaccuracy. Whatever the amount of an annual leakage rate is by counting the car's age from the date of the first registration, it will be a little lower when the assembly day is taken as starting point. This is simply why the assembly is always before the first registration, and any absolute loss measured will decrease relatively by distributing it over a longer time period.

It is possible that considerable time passes between the date of a car's assembly and the date of its first registration, i.e. when it is taken to use. However, looking at the cars of the sample, the period until the first use of the car exceeds rarely two months. In 92 percent of the cases both the month of assembly and the month of first registration were known. On the average, these cars were registered two months (2.1 months, exactly) after the assembly, including Japanese cars transported from Japan. It is worth noting that 32% of the cars were registered in the month of their assembly. (Another 30% were registered one month after the assembly).

The decision for one or another starting point is to some extent arbitrary. The period underlying the leakage rate suggests itself to be the time the MAC is actually leaking. Thus, we are facing the question: Does a MAC lose any refrigerant before the car is driven, i.e. before the date of its first registration?

Evidently, the loss found out at the 300 MACs measured cannot be separated in parts attributable to the time before and attributable to the time after the first registration. All cars were used cars. But as long as the difference between assembly day and date of first registration is no more than two months and the cars are not too

---

<sup>7</sup> In some assembly plants at the end of every shift regularly a "shot" from a charging gun is weighed on precision scales. Mr Boehme, representative of Ford Europe in the Contact Group reported a maximum deviation of 10 grams from the Ford-typical 740-grams norm fill. The Ford Cologne plant is one of the plants where a regular control of the filling charge is obligatory.

young, the one date is basically as good as starting point as the other. This is different if the car's age is less than one year, because 2 months more or less make up a considerable age difference at cars assembled just 7 months back, affecting the leakage rate relatively high. However, the EC measurement programme focuses on cars older than one year with a mean age of 41 months. Thus the leakage rate is not decisively influenced by the choice of the starting date. For practical reasons this study decided to take the date of first registration assuming implicitly that leakage starts from that day onwards.

## **II.5 What is the impact of previous topping-up a MAC, if it remains undetected at the measurement?**

The purpose of the measurements was to establish what the "regular" leakage rate is for MACs. Thus, only "in tact" (i.e. undamaged) MACs could be measured. MACs not meeting these requirements were not measured. Neither should repaired MACs be included in the study (because they are no longer "in tact", and in addition, the date of refill is a source of inaccuracy) nor should those MACs be measured that were topped-up by refrigerant. A visual control of previous repair is to some degree possible for an experienced technician. However, it is not possible to detect a simple "top up" refrigerant (in gaseous state through the low-pressure service port, driven by the running compressor).

As opposed to e.g. the USA where a wide use of small refrigerant cans to charge MACs is reported by Atkinson & Baker (2002) disposable cans are not much used currently in the EU. Nevertheless a topping-up by this way or by means of recovery/recharging stations cannot be excluded for individual cases<sup>8</sup>.

An undetected topping-up of a MAC would distort the overall measurement results. However, firstly, the likelihood of topping-up in the EU is low. Secondly, as the sample consisted of relatively young cars, it is unlikely that the sample included many undetected "topped up" MACs. Thirdly, if a "topped up" MAC were accidentally measured as an "in tact" MAC, the result would be "too good leakage rate" for that MAC (as the result would not take into account the amount of refrigerant that was lost before the topping-up). Thus, the possible (likely small) bias of including "topped up" of the real leakage rate. MACs to the sample suggest that the results are (slight) underestimates.

---

<sup>8</sup> It is possible to prevent such topping up from distorting the calculation of the leakage rate if the car's history from first registration to the date of measurement is known. Such a check could take place by interviewing the current and possible previous car owners, certainly providing fairly uncertain information. Alternatively garages with a good documentation on their cars serviced should be interviewed. Possibly they would provide better data, but also would introduce an undesired bias into the sample. Because the measurements would have to be limited to contract garages only, whose service focuses on relatively young cars within their warranty time. Thus, this approach was excluded in the preparation phase of the measurements.

### III. Composition and representativity of the sample

To establish a regular leakage rate representative for the whole EU, the measurement sample should be designed to mirror the size and composition of the MAC equipped passenger car fleet in the EU<sup>9</sup>.

As budget allowed 300 measurements, compromises were needed. In this section the composition and representativeness of the sample of MACs are described.

#### III. 1. Climatic and national composition

As it was conjectured that leakage rates could vary across different climatic conditions, it was decided that cars with MACs would be measured in three different regions in the EU, with equal sample sizes of 100 measurements.

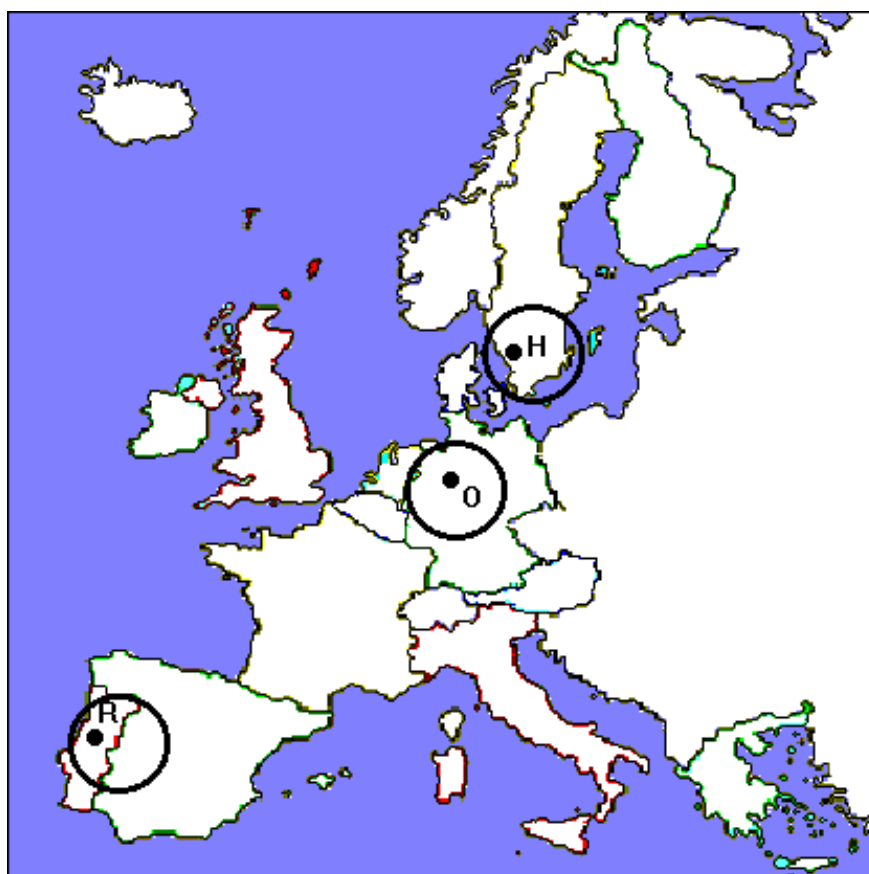

**Figure 6: Geographical distribution of the 300 EC measurements across Europe. In Sweden, Germany, Portugal (circled areas) a hundred MACs each were tested from November 2002 to January 2003. R = Rio Maior. O = Osnabrück. H =Helsingborg.**

<sup>9</sup> Ideally, it should take into account all the 15 different-sized Member States to meet the total of the different national and geographic conditions. The national fleets should subdivide themselves representatively into all the car makes they consist of. Further, makes should be broken into individual models, and the models for their part should be mirrored in the sample by age-groups, as the MAC quota generally is the higher the younger the cars are and vice versa. Such an ideal programme would need some 10.000 measurements.

The regions selected were central Germany (Osnabrück), southern Sweden (Helsingborg) and northern Portugal (Rio Maior). The weather and climate conditions of Osnabrück are moderate and by that typical for the use of MACs in large parts of continental Europe.

Helsingborg area of Sweden is of interest because of its coastal location with salty sea-air as well as the relatively strong winters with salted roads' surfaces. Both factors were expected to provide a corrosive atmosphere to the MACs and to result in higher than EU average leakage rates.

In Portugal, in the rural area around the town Rio Maior (100 km north of Lisbon) hot summers were expected to make the MACs run a long time of the year, significantly longer than in central or northern parts of Europe. Thus, it was of interest to see, if this would have a positive or negative impact on the leakage rate of MACs.

### **III. 2. Make composition**

To further the purpose of the study to determine the average leakage rate of relatively new "second generation" MACs, efforts were made to measure as many makes and models as possible so that an EU-wide average leakage rate could be established. Thus, the comparison between the three selected regions is not as meaningful as if the same makes had been selected in all three regions.

In practice, the sampling was carried out by selecting 19 different garages (see Annex II of the garages that participated in the survey) in Germany (4 garages), Portugal (9 garages) and Sweden (6 garages). The cars selected to the sample were selected from these garages.

How far the makes are represented in the sample with their main models, is shown in the Table 2. The total is already corrected and consists of only 276 of the 300 cars measured ("EC-276"). On the average, each make is more than half its total amount represented by one model (146 of 276).

| <b>Make</b> | <b>Number</b> | <b>Of which Model</b> | <b>Number</b> | <b>Make</b>  | <b>Number</b> | <b>Of which Model</b> | <b>Number</b> |
|-------------|---------------|-----------------------|---------------|--------------|---------------|-----------------------|---------------|
| Audi        | 27            | A 4                   | 16            | Opel         | 34            | Astra                 | 14            |
| BMW         | 17            | 3-Series              | 9             | Peugeot      | 15            | 306                   | 8             |
| Citroen     | 4             | Xsara                 | 2             | Renault      | 27            | Megane                | 15            |
| Chrysler    | 1             | Voyager               | 1             | Saab         | 9             | 9-5                   | 5             |
| Fiat-Gr.    | 5             | Marea                 | 2             | Seat         | 4             | Leon                  | 2             |
| Ford        | 26            | Focus                 | 14            | Skoda        | 1             | Octavia               | 1             |
| Honda       | 5             | Civic                 | 3             | Suzuki       | 3             | Gr Vitara             | 3             |
| Mazda       | 1             | 323                   | 1             | Toyota       | 6             | Corolla               | 5             |
| Mercedes    | 17            | C-Class               | 6             | Volvo        | 27            | S70/V70               | 15            |
| Mitsubishi  | 6             | Lancer                | 3             | VW           | 36            | Golf                  | 17            |
| Nissan      | 5             | Primera               | 4             | <b>Total</b> | <b>276</b>    |                       | <b>146</b>    |

The sample comprises exclusively cars with MACs. One issue was, how close the sample reflects the composition of car makes in the EU.

The real make composition of the EU car fleet can be obtained with the help of annually published new registration figures by individual makes. Such lists are regularly published e.g. by ACEA (Association des Constructeurs Européens d'Automobiles). They enable in Table 3 a presentation to be shown of the make composition of the EU-wide new registrations of passenger cars cumulated over the six whole years from 1996 to 2001. These are the years this study focuses on.

| <b>Table 3: Market shares of individual car makes, new registered from 1996 (begin) to 2001 (end) within the EU-15 – according to ACEA</b> |                            |                            |
|--------------------------------------------------------------------------------------------------------------------------------------------|----------------------------|----------------------------|
| 1. Make                                                                                                                                    | 2. New registrations 96-01 | 3. Market share in percent |
| BMW                                                                                                                                        | 2,813,408                  | 3.3                        |
| Chrysler                                                                                                                                   | 405,075                    | 0.5                        |
| Mercedes                                                                                                                                   | 3,710,732                  | 4.4                        |
| Fiat (incl. Alfa, Lancia)                                                                                                                  | 8,871,696                  | 10.3                       |
| Ford                                                                                                                                       | 8,308,950                  | 9.7                        |
| Volvo                                                                                                                                      | 1,374,155                  | 1.6                        |
| Opel/Vauxhall                                                                                                                              | 9,324,290                  | 10.9                       |
| Saab                                                                                                                                       | 423,690                    | 0.5                        |
| Citroen                                                                                                                                    | 4,253,601                  | 5.0                        |
| Peugeot                                                                                                                                    | 6,318,592                  | 7.4                        |
| Renault                                                                                                                                    | 8,949,019                  | 10.5                       |
| Audi                                                                                                                                       | 2,909,626                  | 3.4                        |
| SEAT                                                                                                                                       | 2,223,141                  | 2.6                        |
| Skoda                                                                                                                                      | 997,001                    | 1.2                        |
| Volkswagen                                                                                                                                 | 9,335,293                  | 11.0                       |
| Japanese                                                                                                                                   | 9,613,460                  | 11.3                       |
| Honda                                                                                                                                      | 1,168,938                  | 1.4                        |
| Mazda                                                                                                                                      | 1,105,065                  | 1.3                        |
| Mitsubishi                                                                                                                                 | 984,283                    | 1.2                        |
| Nissan                                                                                                                                     | 2,347,312                  | 2.8                        |
| Suzuki                                                                                                                                     | 790,031                    | 0.9                        |
| Toyota                                                                                                                                     | 2,716,772                  | 3.2                        |
| Other Japanese                                                                                                                             | 501,059                    | 0.5                        |
| Others*                                                                                                                                    | 5,388,884                  | 6.2                        |
| <b>Total 96-01</b>                                                                                                                         | <b>85,220,613</b>          | <b>100%</b>                |

Korean makes, Rover, Land Rover, Smart, Jeep, GM USA, Ford USA, Porsche.

Source: ACEA

In Table 3 the main makes represent 93.8 percent of the new registrations cumulated over the 1996-2001 period. However, these figures leave it open to what extent the cars were equipped with MACs. As the sample's make-mix has to be compared with the EU-wide fleet of cars equipped with MACs, in the next step the make-specific MAC installation rates needed to be established.

Publications on MAC installations by country or by make are not yet available, for the entire EU. However, the London office of Global Insight has collected MAC data from seven major EU countries of the installation rates (MAC shares) for each make. This data represents 88.5% of the EU car fleet, and thus serves as suitable proxy for the

total MAC-equipped EU car fleet (table 4). For the purpose of this study Global Insight provided an analysis of the make specific MAC installation rates for the six registration years from 1996 to 2001.

| <b>Table 4: Market shares of individual car makes without and with MACs, new registered from 1996 (begin) to 2001 (end) in the EU-15</b> |                                                          |                                                       |                                                                      |                                             |
|------------------------------------------------------------------------------------------------------------------------------------------|----------------------------------------------------------|-------------------------------------------------------|----------------------------------------------------------------------|---------------------------------------------|
| 1. Make                                                                                                                                  | 2. Market share of all new registrations 96-01 (percent) | 3. Share of MACs of new registrations 96-01 (percent) | 4. MAC weighting factor. Relation individual/average MAC quota (= 1) | 5. Market share of MAC cars 96-01 (percent) |
| BMW                                                                                                                                      | 3.3                                                      | 84.7                                                  | 1.41                                                                 | 4.7                                         |
| Chrysler                                                                                                                                 | 0.5                                                      | 95.6                                                  | 1.59                                                                 | 0.8                                         |
| Mercedes                                                                                                                                 | 4.4                                                      | 89.2                                                  | 1.49                                                                 | 6.5                                         |
| Fiat (+Alfa, Lancia)                                                                                                                     | 10.4                                                     | 45.2                                                  | 0.75                                                                 | 7.9                                         |
| Ford                                                                                                                                     | 9.7                                                      | 60.6                                                  | 1.01                                                                 | 9.9                                         |
| Volvo                                                                                                                                    | 1.6                                                      | 81.7                                                  | 1.36                                                                 | 2.2                                         |
| Opel/Vauxhall                                                                                                                            | 10.9                                                     | 61.5                                                  | 1.03                                                                 | 11.2                                        |
| Saab                                                                                                                                     | 0.5                                                      | 93.0                                                  | 1.55                                                                 | 0.8                                         |
| Citroen                                                                                                                                  | 5.0                                                      | 54.5                                                  | 0.91                                                                 | 4.5                                         |
| Peugeot                                                                                                                                  | 7.4                                                      | 52.6                                                  | 0.88                                                                 | 6.5                                         |
| Renault                                                                                                                                  | 10.5                                                     | 56.2                                                  | 0.94                                                                 | 9.8                                         |
| Audi                                                                                                                                     | 3.4                                                      | 90.8                                                  | 1.51                                                                 | 5.2                                         |
| SEAT                                                                                                                                     | 2.6                                                      | 58.4                                                  | 0.97                                                                 | 2.5                                         |
| Skoda                                                                                                                                    | 1.2                                                      | 47.7                                                  | 0.80                                                                 | 0.9                                         |
| Volkswagen                                                                                                                               | 11.0                                                     | 61.6                                                  | 1.03                                                                 | 11.2                                        |
| Japanese                                                                                                                                 | 11.3                                                     | 60.0                                                  | 0.82                                                                 | 9.3                                         |
| Honda                                                                                                                                    | 1.4                                                      | 42.0                                                  | 0.69                                                                 | 1.0                                         |
| Mazda                                                                                                                                    | 1.3                                                      | 61.0                                                  | 1.00                                                                 | 1.3                                         |
| Mitsubishi                                                                                                                               | 1.2                                                      | 60.0                                                  | 0.99                                                                 | 1.2                                         |
| Nissan                                                                                                                                   | 2.8                                                      | 60.0                                                  | 0.99                                                                 | 2.8                                         |
| Suzuki                                                                                                                                   | 0.9                                                      | 35.0                                                  | 0.57                                                                 | 0.5                                         |
| Toyota                                                                                                                                   | 3.2                                                      | 42.0                                                  | 0.69                                                                 | 2.2                                         |
| Other Japanese                                                                                                                           | 0.5                                                      | 30.0                                                  | 0.50                                                                 | 0.3                                         |
| Others*                                                                                                                                  | 6.2                                                      | 60.0                                                  | 1.00                                                                 | 6.2                                         |
| <b>Total 96-01</b>                                                                                                                       | <b>100.0</b>                                             | <b>60.0</b>                                           | <b>1.00</b>                                                          | <b>100.0</b>                                |

\* Korean makes, Rover, Land Rover, Smart, Jeep, GM USA, Ford USA, Porsche.

Sources: Column 2 (Table 3), Column 3 (Global Insight, David Smith-Tilley, pers. Comm).  
 Explanation: Column 4 was counted by dividing the MAC quota (column 3) by the 60% average MAC share in the EU (last row). Column 5 is the product of column 2 and 4. For instance the MAC weighting factor for Audi is  $90.8/60 = 1.51$  and the market share in the MAC-equipped car-fleet is  $1.51 * 3.4\% = 5.2\%$ .

Column 5 of table 4 gives the estimated market shares of each car make with MACs for the cars sold in the EU between 1996 and 2001.<sup>10</sup>

<sup>10</sup> The following explains how table 4 was derived:

1. Starting point is column 2, namely the individual market share of a make in all new registrations made up between the begin of 1996 and the end of 2001. These figures are identical with those in Table 3, column 3.

2. The next step is in column 3 the introduction of individual MAC quotas as percentages of MAC-equipped cars compared to all new-registered cars of a particular make, during the six years from



Table 5 compares the sample of measured cars with MACs with the population of MACs that were placed on the market in 1996-2001.

**Table 5: Share of MAC equipped cars by make in the EU-15 and the sample**

| 1. Make              | 2. Share of MAC cars in EU-15 (%) | 3. Share in sample (%) (N=276) * |
|----------------------|-----------------------------------|----------------------------------|
| BMW                  | 4.7                               | 6.2                              |
| Chrysler             | 0.8                               | 0.4                              |
| Mercedes             | 6.5                               | 6.2                              |
| Fiat (+Alfa, Lancia) | 7.9                               | 1.8                              |
| Ford                 | 9.9                               | 9.4                              |
| Volvo                | 2.2                               | 9.8                              |
| Opel/Vauxhall        | 11.2                              | 12.3                             |
| Saab                 | 0.8                               | 3.3                              |
| Citroen              | 4.5                               | 1.4                              |
| Peugeot              | 6.5                               | 5.4                              |
| Renault              | 9.8                               | 9.8                              |
| Audi                 | 5.2                               | 9.8                              |
| SEAT                 | 2.5                               | 1.4                              |
| Skoda                | 0.9                               | 0.4                              |
| Volkswagen           | 11.2                              | 13.0                             |
| Japanese             | 9.3                               | 9.5                              |
| Others               | 6.3                               | 0.0                              |
| <b>Total</b>         | <b>100.0</b>                      | <b>100</b>                       |

\* In anticipation of the exclusion of outliers, the sample comprises 276 (instead of 300) measured MACs. Source of column 2 is Table 4, column 5. Source of column 3 is Table 2.

The adjusted, MAC-weighted, make figures are presented in Table 5 under the heading "Share of MAC cars in EU-15" as percentages of the total MAC equipped EU passenger car fleet made up over six years from 1996 to 2001. For comparison in the column "Share in sample" the make composition of the 276 measured cars with MACs is shown. It should be noted that 24 observations were excluded from the analysis as outliers (see Chapter IV).

A row-by-row comparison of the figures in Table 5, column 2, with the respective figures in column 3 facilitates a rough judgement of how close to the (estimated) reality within the EU-15 the measurements are by limiting the sample to just 3 out of the 15 countries.

---

1996 to 2001. These quotas were provided by Global Insight, London, for all makes except the Japanese cars made outside the EU. The latter were taken for the Öko-Recherche archives. The average MAC quota for all the cars new-registered in the EU from 1996 to 2001 amounts to 60%.

3. MAC weighting factors are achieved by relating the individual MAC quotas to the average MAC quota of the total EU car fleet. Setting the average of 60% (see Table 4, last row, column 3) equal to 1, the weighting factor for a make with a higher MAC quota shows a value of more than 1 and a make with a MAC quota in the same time period below the average shows a factor below 1.

4. Finally, the market share of a make in the total of MAC-equipped cars is arrived at by multiplying the market share in all registrations (column 2) by the MAC weighting factor in column 4. From the product of market share and weighting factor in column 5 can be read off how far a make's market share in the MAC equipped car fleet is higher or lower than its market share in the car fleet disregarding the MAC.

The sample shows a strong bias for Audi (9.8% to 5.2%), Volvo (9.8% to 2.2%) and Saab (3.3% to 0.8%) compared to their relative shares in the "EU-15 MAC cars". This is due to the large share of these makes in their home fleets Germany and Sweden.

Conversely Fiat (1.8% to 7.9%), and Citroen (1.4% to 4.5%) are under represented in the sample compared to the EU-15 population reality. The same applies to other makes (0% to 6.2%).

These weights established by using the shares in Table 4 and 5 will be used again later to calculate a weighted average of the leakage rates.

### **III.3 Age composition**

Every year since 1993, the percentage of new cars equipped with MACs has been growing at a very substantial rate all over the EU, and the point of saturation is not yet reached. Consequently, the share of vehicles with MACs was different not only for each make of car, but also for each year of registration.

It was expected that share of the under 1 year old cars would be small. For reasons explained in Chapter IV.1 cars younger than 12 months (since first registration) at the date of measurement<sup>11</sup> and cars older than 7 years were excluded as outliers.

Figure 7 shows the annual share of new registered cars with MACs in percent of the total graphically as bars next to each other along the x-axis representing years since first registration of vehicle before the measuring date.

The bars represent the real age distribution of cars with MAC new-registered in the EU between 1996 and 2001. According to Global Insight, the respective figures gradually move from 9.1% in 1996 to 23.5% in 2001.

---

<sup>11</sup> The age of a car as far as it is relevant for its MAC leakage rate is here defined as the time from its first registration until the date of measuring its charge (Nov 2002/Jan 2003).

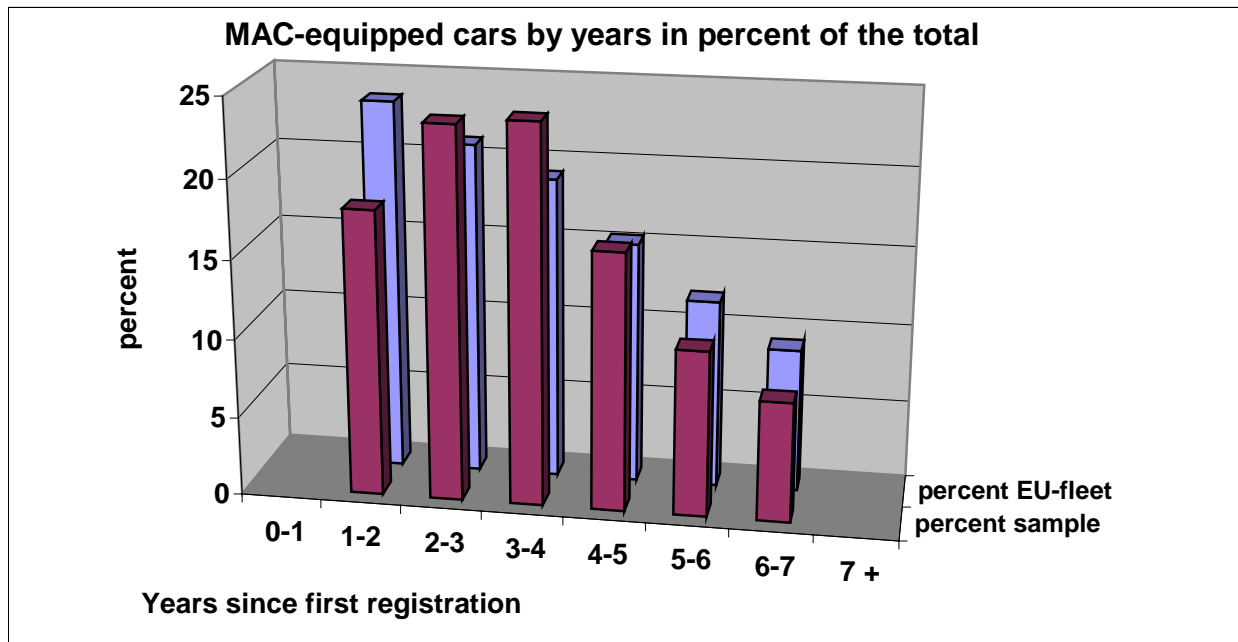

**Figure 7: MAC-equipped cars by annual age-groups in percent of the total. The back bars (blue) the estimated shares of MAC equipped cars. The front (red) bars show the age distribution in the sample: the first age group (1-2 years) is under-represented and the third (3-4 years) over-represented.**

In the sample (N=276 cases after excluding outliers) the age group 1-2 years is under-represented and 3-4 year old cars are over-represented in the sample.

### **III. 4 Summary**

The difference between the sample and the MAC-weighted EU-15 fleet is rather small. The main concern is the relative over-representation of some marks (German and Swedish) and under-representation of others (French and Italian). Also the share of relatively young cars (<2 years) with MACs was under-represented.

However, the measurement sample seems to correspond fairly well to the population of cars with MACs in EU-15 and thus the estimation of the EU-wide annual leakage rate could be established, after removing some outliers from the sample. This is discussed in Chapter IV.

## IV. Elimination of outliers from the sample

In this chapter first (IV.1) the age distribution of the 300 measurements is given before and after exclusion of some of the measurements which were not suitable for the purposes of this study.

As a result of the removal of “first generation” MACs (>7 years), the group of under 1 year old cars and two other outliers, sample decreased from original 300 cases to 276. The details of excluding 24 outliers are given. This is followed by showing how the measurement was corrected by adding of 20 grams of HFC-134a to each measurement.

Figure 8 and Table 6 show the age distribution of the measurements made in the study. The lion share (74%) of the measurements fall to the age group 1-4 years.

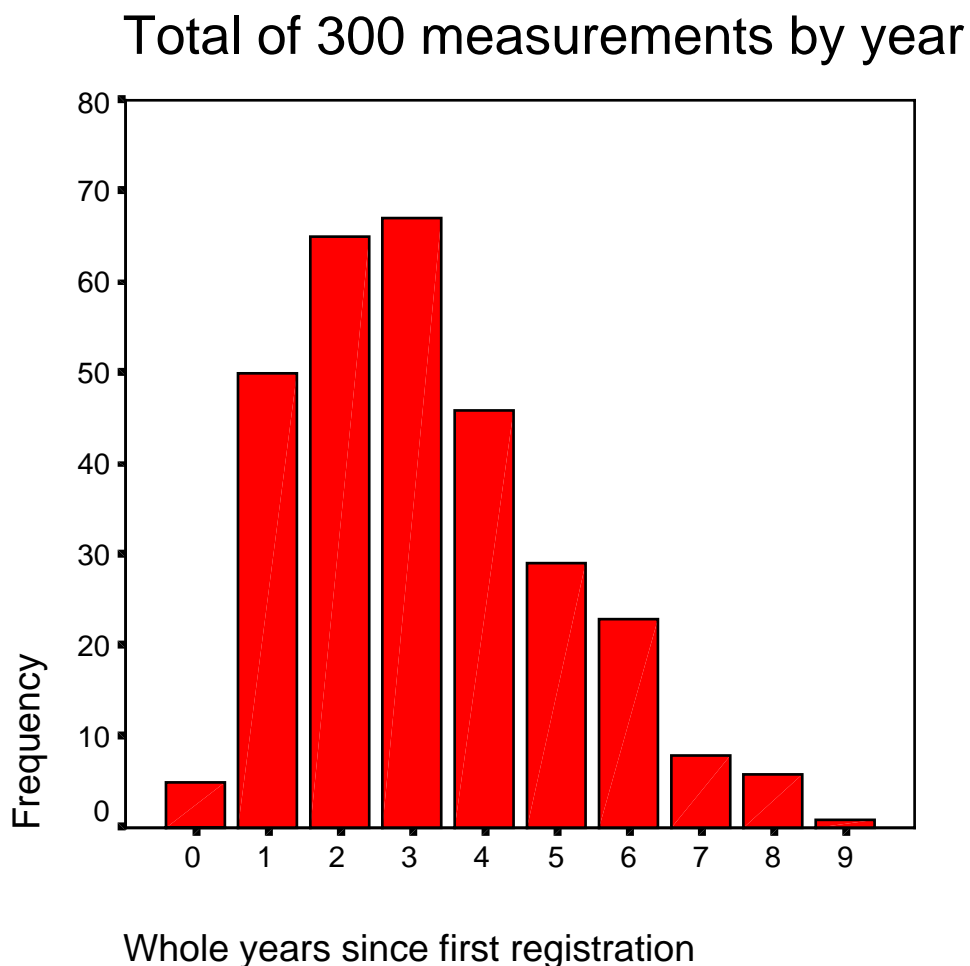

**Figure 8: Total of the 300 cases, by years. Before correction, the graph shows a clear concentration on the years 1 to 6, which is in months from 12 to 83.**

| <b>Table 6: Age distribution of the 300 MACs measured, before correction</b> |              |            |                    |                               |
|------------------------------------------------------------------------------|--------------|------------|--------------------|-------------------------------|
| Main Year of registration                                                    | Age in years | Frequency  | Share (in percent) | Cumulative share (in percent) |
| 2002                                                                         | 0            | 5          | 1.7                | 1.7                           |
| 2001                                                                         | 1            | 50         | 16.7               | 18.3                          |
| 2000                                                                         | 2            | 65         | 21.7               | 40.0                          |
| 1999                                                                         | 3            | 67         | 22.3               | 62.3                          |
| 1999                                                                         | 4            | 46         | 15.3               | 77.7                          |
| 1997                                                                         | 5            | 29         | 9.7                | 87.3                          |
| 1996                                                                         | 6            | 23         | 7.7                | 95.0                          |
| 1995                                                                         | 7            | 8          | 2.7                | 97.7                          |
| 1994                                                                         | 8            | 6          | 2.0                | 99.7                          |
| 1993                                                                         | 9            | 1          | 0.3                | 100.0                         |
| <b>Total</b>                                                                 |              | <b>300</b> | <b>100.0</b>       |                               |

## IV.1 Removal of too old or too young MACs

### IV.1.1 Elimination of 18 MACs older than seven years

In discussions with the Contact Group it was decided that only relative young cars should be selected so that the “teething problems” of the “first generation” HFC-based MACs would not be picked up. The logic was that the leakage rate of the relatively new “second generation” MACs would be a fairly good proxy of the average leakage rates for the years to come (disregarding the belief that due to aging effect the leakage of MACs is likely to increase). The experts in the group estimated that the teething problems of the “first generation” HFC MACs were sorted out by 1996-7 and thus MACs installed to cars since then could be included in the sample. During the course of the measurements therefore the technician had been instructed to include only cars that were first registered since 1996. Thus, 15 MACs from the pre 1996 period which had accidentally been included into the survey had to be discarded from the analysis.

After later decoding the VINs by car manufacturers for the date of assembly it turned out that three more vehicles were too old. Although their first registration dated back only 72, 82 and 52 months, their actual dates of assembly and of MAC charging was 100, 93 and 93 months before measuring. Not attributable to “second generation MACs”, these three vehicles were removed as outliers.

### IV.1.2. Removal of two overcharged MACs

In the sample two MACs were found with a significant higher charge than the norm fill. A ten-month-old car was found with overfill of 80 grams, and a 38-month-old car came with 190 grams more refrigerant in the MAC, than it ought to have. These overcharges far beyond the possible tolerances of the first fill were eliminated from the sample.

A likely explanation for the occurrence of overcharged MACs which were apparently not topped up is as follows. When a ready car passes the quality control at the end of the assembly line, and a mistake (mostly at the engine) is located (which is the case in roughly 1% of the cases) the MAC is opened and removed manually to get access

to the engine. After re-installing the engine the MAC is closed again and – that is the point – in some plants not recharged by the automatic filling machine, but manually with a usual recharging station, by far less accurate<sup>12</sup>.

#### IV.1.3 Elimination of 4 MACs younger than one year

Four vehicles with MACs less than one year old (0 years) since first registration were measured, too. The concept of the measuring project was that the EC core study focuses on the analysis of vehicles between 1 and 6 years of age. Younger cars were measured in another study financed by NOVEM in October 2002<sup>13</sup>.

After the removal of all 24 outliers the age distribution looks as shown in Table 7.

| Years        | Frequency  | Percent      | Cumulative Percent |
|--------------|------------|--------------|--------------------|
| 1            | 50         | 18.1         | 18.1               |
| 2            | 65         | 23.6         | 41.7               |
| 3            | 66         | 23.9         | 65.6               |
| 4            | 45         | 16.3         | 81.9               |
| 5            | 29         | 10.5         | 92.4               |
| 6            | 21         | 7.6          | 100.0              |
| <b>Total</b> | <b>276</b> | <b>100.0</b> |                    |

#### **IV.2 The correction of the measuring differences by 20 grams**

The second step of the data preparation is result of the accuracy tests before and after the field measurements. As reported and discussed in chapter II, it was established that on the average 20 grams of HFC-134a was not recovered from the MACs during the measurement. Therefore, in the analysis 20 grams of HFC-134a was added to each measurement to compensate the fact that 20 grams of refrigerant remained on the average in the MAC after each measurement.

As the compensation is made to all measurements, this generates a small inconsistency within the corrected sample. In eight cases of the total the amount of HFC-134a measured is so small, that by adding 20 grams as compensation "negative differences" between the original charge and the measured charge occur. One explanation to this anomaly is that the original charge was somewhat higher than the nominal charge. If e.g. the norm charge was  $750 \pm 50$  grams, the original charge could have been e.g. 800 grams while in this study it is assumed to be 750 grams. If 60 grams were leaked in reality, with the compensation of 20 grams, it would look like that after the registration -10 grams of HFC-134a would have leaked.

Another explanation is that the measured MAC would be very leak tight (i.e. better than fleet average) and have leaked only e.g. 10 grams in the first year since registration. Thus, the leak rate would again look like -10 grams.

<sup>12</sup> Bjarne Lund, AGramkow, Denmark (Pers. Comm. at the VDA Winter Meeting, Saalfelden, 2003).

<sup>13</sup> The analysis of the data from the measurements of 140 MACs (which were mainly cars that were under 1 year of age) carried out on behalf of NOVEM in October 2002 will be made available in a separate report.

It needs to be kept in mind that the specific value of the 20 gram correction for incomplete recovery is a mean value representing a broader distribution of sometimes higher or lower values.

In sum, the compensation of 20 grams resulted into an inconsistency with the initial assumption that no initial over-charging would take place. This warranted further correction for which in principle two approaches were possible: i) either change the negative differences to "differences zero" and keep them in the sample or ii) eliminate these measurements from the sample.

For this analysis it was decided to not remove the cases of negative calculated losses (= refrigerant gains) from further analysis, as they represented well performing systems. Therefore, their leakage rates were set to zero. The effect of this is that the average leakage rate of the sample increased by about 0.2 g/year.



## V. The Results: Annual Regular Leakage Rate of MACs in EU-15

### V.1 The average leakage rate per year in grams and percent

Table 8 gives the sample means of the data.

|                          |                       |                      |           |
|--------------------------|-----------------------|----------------------|-----------|
| Norm charge per MAC      | 756 grams             | Annual mileage       | 20,853 km |
| Age of the MACs          | 40.9 months           | Mileage              | 66,443 km |
| Ambient temperature      | 14.8 °C               | Duration of recovery | 25.5 min  |
| Cubic capacity of engine | 1,940 cm <sup>3</sup> |                      |           |

The annual regular leakage rate is derived by relating the refrigerant loss measured (as difference between recovered quantity and standard ex-works charge), to the time (by single months) elapsed since the vehicle's first registration,<sup>14</sup>. From the estimates for each of the 276 MACs, an individual average of the 276 different regular leakage rates is calculated. The absolute value amounts to 52.4 grams/year (Table 9).

|         | Valid N | Minimum | Maximum | Mean | Std. Error |
|---------|---------|---------|---------|------|------------|
| Grams   | 276     | 0.0     | 208     | 52.4 | 2.30       |
| Percent | 276     | 0.0     | 27.0    | 6.91 | 0.29       |

The mean of 52.4 grams is estimated at a confidence level of 95 percent. As the Standard Error (SE) is 2.3, the 95 % Confidence Interval is 52.4 g  $\pm$  4.6 g ( $\pm$  2 SE). This interval between 47.8 grams and 57.0 grams is the range within the true mean of the population (the MAC-equipped car fleet cumulated from 1996 to 2001) lies with a likelihood of 95%.

The relative annual leakage rate is the percentage of the measured difference against the MAC's norm charge, which is annualised in the same way as above. It is found to be 6.9% per year.

Table 10 shows the effect of removing the outliers from the sample. The average annual leakage rate of all the 300 measurements (raw data) was slightly below 60 (59.5) grams. After the removal of the outliers (24 MACs) the average annual leakage rate (59.6 grams) is still similar as in the beginning. When the addition of 20 grams to the recoveries to compensate the unrecoverable refrigerant was made, the main result of this study, being the average annual leakage rate of 52.4  $\pm$  4.6 grams is established

<sup>14</sup> The calculation is done by dividing the difference in grams by the number of months since first registration, and the calculated amount is multiplied by 12.

| Table 10: Steps of correction of the average annual leakage rate |             |                      |                        |                         |                               |
|------------------------------------------------------------------|-------------|----------------------|------------------------|-------------------------|-------------------------------|
| Step of correction                                               | 1. Raw data | 2. Remove older 7 yr | 3. Remove 2 overfilled | 4. Remove 4 younger 1 y | 5. Add 20 gr., set minus zero |
| <i>Number</i>                                                    | 300         | 282                  | 280                    | 276                     | 276                           |
| <b>Leakage rate gr/y</b>                                         | <b>59.5</b> | <b>60.6</b>          | <b>61.4</b>            | <b>59.6</b>             | <b>52.4</b>                   |
| Error band grams                                                 | ±5.1        | ±5.3                 | ±5.2                   | ±4.8                    | ±4.6                          |
| <b>Leakage rate perc</b>                                         | <b>7.8</b>  | <b>8.1</b>           | <b>8.2</b>             | <b>7.9</b>              | <b>6.9</b>                    |
| Error band percent                                               | ±0.7        | ±0.7                 | ±0.7                   | ±0.6                    | ±0.6                          |

### V.2 The scattered profile of the individual annual leakage rates

The 52.4 grams/y or the 6.9% annual leakage rate is an average calculated from widely scattered individual cases, compensating for major variations upwards and downwards. Figure 9 gives the individual annual leakage rates in grams/yr by frequency columns in 20-grams-steps of from 0 to 220 grams.

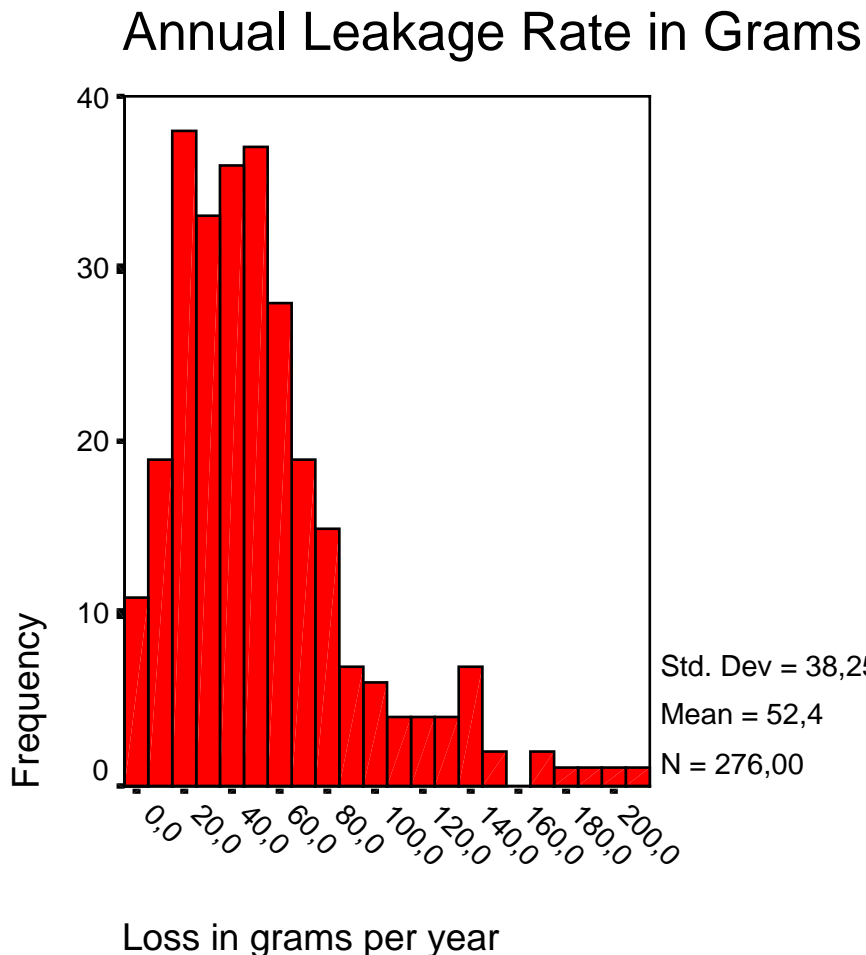

**Figure 9: The 276 regular annual leakage rates in 20-gram-sections, by frequency. The average of the scattered leakage rates amounts to 52.4 grams of HFC-134a, annually.**

### V.3 Age dependency of the leakage rates

Figure 10 gives the scattergram of the amounts of leaked refrigerant (without annualising) against months of use of cars. As expected, the older the car the more HFC-134a has leaked from it.

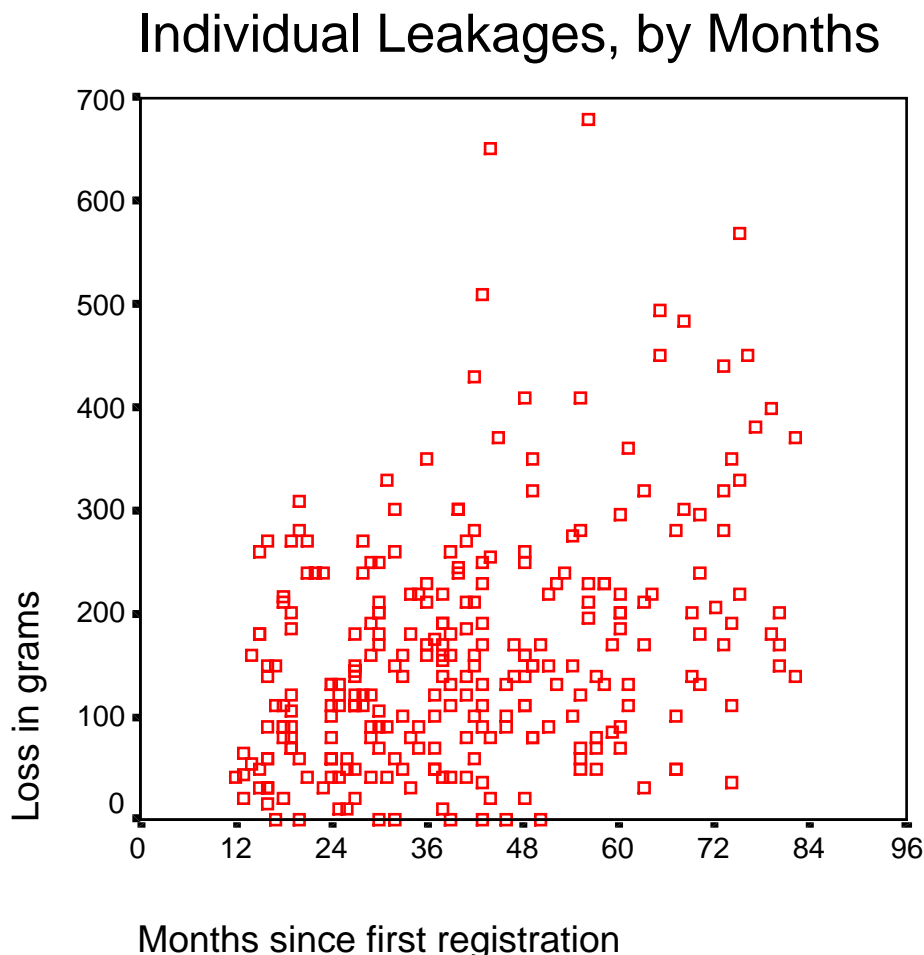
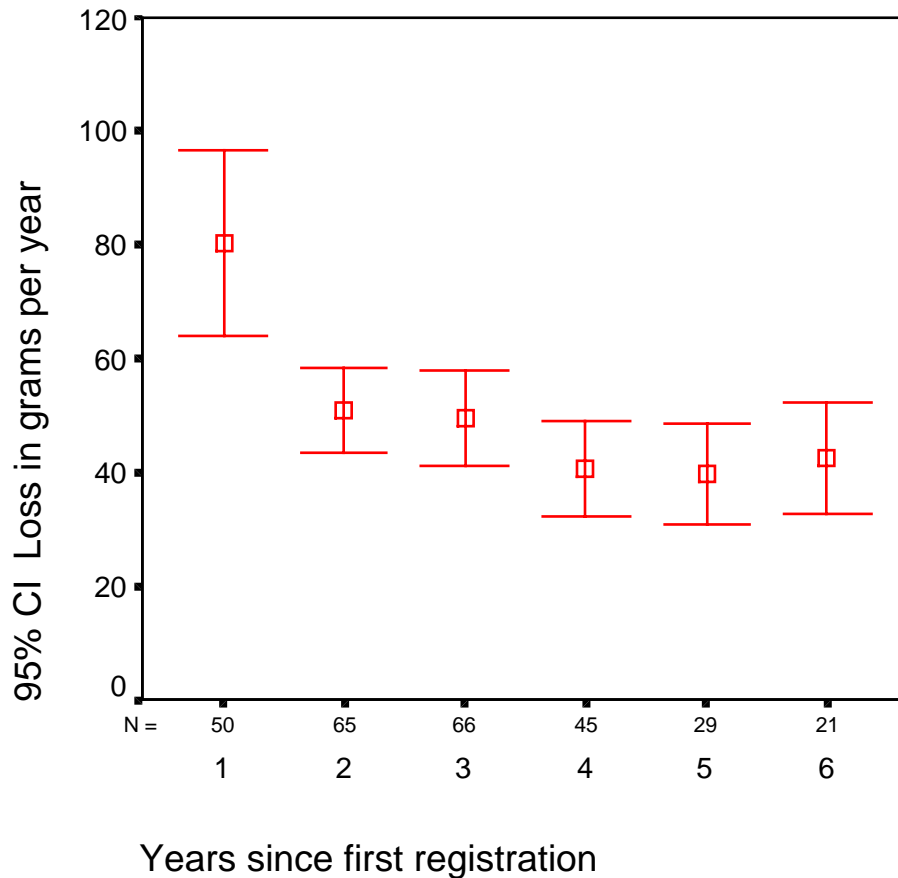

**Figure 10: The MAC leakages in months since first registration. The data points of the 276 loss rates show a principal direction going from bottom left to top right.**

Obviously, refrigerant losses do not take an identical course in every single MAC. There are too many influencing factors. For instance, the duration of time for which individual systems remain switched on over the lifetime of a vehicle can be expected to vary widely, even in the same climatic region, from about 50 to more than 250 hours per annum in Europe. Then, the life of a vehicle's engine (as it undergoes vibration and the development of heat), actually a more important aspect in the context of regular leakage, also varies widely from about 100 to more than 800 hours - and this is not allowing for mileage and for traffic conditions. Another factor would be the driver's personal driving habits, which will have a varyingly stressful effect. Again, the way the MAC is operated by the owner and used has a part to play, and the ambient temperature co-determining a system's pressure is not the same for every unit (car garaged or parked in the open). Moreover, the quality of workmanship in one MAC is not absolutely the same as in the next.

As an obvious next step one moves to the annual average leakage rates individually, in order to test their path along the years of the time-axis.

## Annual Leakage Rate, by Years



**Figure 11: Average annual leakage rates, by years since first registration. Unlike the high figure of the year 1-2, the following five annual leakage rate show a relatively high uniform picture. All the figures are located between 40 and 50 grams**

| <b>Year</b>                 | <b>1</b>    | <b>2</b>    | <b>3</b>    | <b>4</b>    | <b>5</b>    | <b>6</b>    |
|-----------------------------|-------------|-------------|-------------|-------------|-------------|-------------|
| <i>Number</i>               | 50          | 65          | 66          | 45          | 29          | 21          |
| <b>Leakage rate grams/y</b> | <b>80.3</b> | <b>50.7</b> | <b>49.6</b> | <b>40.6</b> | <b>39.8</b> | <b>42.6</b> |
| Error band grams            | ±16.1       | ±7.5        | ±8.3        | ±8.3        | ±8.5        | ±9.4        |
| <b>Leakage rate percent</b> | <b>10.5</b> | <b>7.0</b>  | <b>6.5</b>  | <b>5.3</b>  | <b>4.9</b>  | <b>5.4</b>  |
| Error band percent          | ±2.0        | ±1.1        | ±1.1        | ±1.0        | ±0.9        | ±1.3        |
| <i>Av. Age in months</i>    | 17          | 29          | 41          | 53          | 65          | 76          |
| <i>Av. Charge grams</i>     | 737         | 734         | 756         | 767         | 795         | 790         |

Figure 11 and Table 11 show, that the average annual leakage rate in the sample is not constant over the time, as it could have been assumed from the presentation at the beginning of this chapter. The average leakage rate of 52.4 grams of HFC-134a per year are only applicable over the total of the six years. By annualising the leakage rate it turns out that – for some reason – very young MACs seem to have a higher leakage rate than older ones. The leakage rate of the 1-2 year old cars is considerably higher (80.3 grams per year) than in the subsequent years. Further, the

leakage rate seems to diminish until the 5<sup>th</sup> year. In this study it was not possible to study why such a phenomenon might occur. However, it seems important to carry out further research to establish why the leakage rate would be high during the first years of the MACs operation.

#### V.4 Average annual leakage rates by countries

Chapter III on the representativity of the sample selected for this survey gave reasons why the measurements were carried out in three different countries. Sweden Germany and Portugal were selected to find out the impact of differing climatic conditions on the size of the average annual leakage rates of from one to six years old MACs.

| <b>Country</b>              | <b>Germany</b> | <b>Sweden</b> | <b>Portugal</b> |
|-----------------------------|----------------|---------------|-----------------|
| <i>Number</i>               | 90             | 95            | 91              |
| <b>Leakage rate grams/y</b> | <b>48.7</b>    | <b>54.3</b>   | <b>54.0</b>     |
| Error band grams            | ±8.2           | ±8.1          | ±7.6            |
| <b>Leakage rate percent</b> | <b>6.2</b>     | <b>7.0</b>    | <b>7.5</b>      |
| Error band percent          | ±1.1           | ±1.0          | ±1.0            |
| <i>Av. Age in months</i>    | 46             | 35            | 41              |
| <i>Av. Charge grams</i>     | 778            | 767           | 722             |

Table 12 shows that the regular leakage rate in grams/year does not grow from North to South. The lowest annual leakage rate both by grams and by percent is in Germany, where the climate is relatively moderate. The simple rule of thumb: the higher the temperature the longer the MAC running time and the higher the leakage, is obviously not correct. With 54.3 grams, the highest leakage rate is found in the northern country Sweden, while in the southern country Portugal this figure amounts to 54.0 grams.

All the differences lie within the error bands of the means. However, this study gives no evidence to the claim that the leakage rate of a MAC would be higher under warm than cold climatic conditions. Taking into account the larger average MAC charges in Sweden (767 grams) against those in Portugal (722), the percentages of the annual refrigerant leakages are higher in Portugal, with 7.5 percent, compared to Sweden with 7.0 percent, neither providing a significant confirmation of the hypothesis that warm climate leads to higher loss.

The reasons for country-specific differences in the leakage rate are complex. For example, in Sweden the salty road surfaces in winter and corrosive ambient air (from North Sea in the coastal town of Helsingborg) are likely to effect MACs thus increasing regular leakage rate. To find out the reasons for the country specific leakage rate differences a more in-depth investigation (including the make compositions) would be necessary. This was beyond scope of this study.

### V.5 Average annual leakage rates by car make

Chapter III on representativity also deals with the make composition of the sample. The question there is, how close the sample comes to the EU-wide MAC equipped car fleet. Wide differences between the individual annual leakage rates of the makes seem to exist (Figure 12 and Table 13).

## Annual Leakage Rates, by Makes

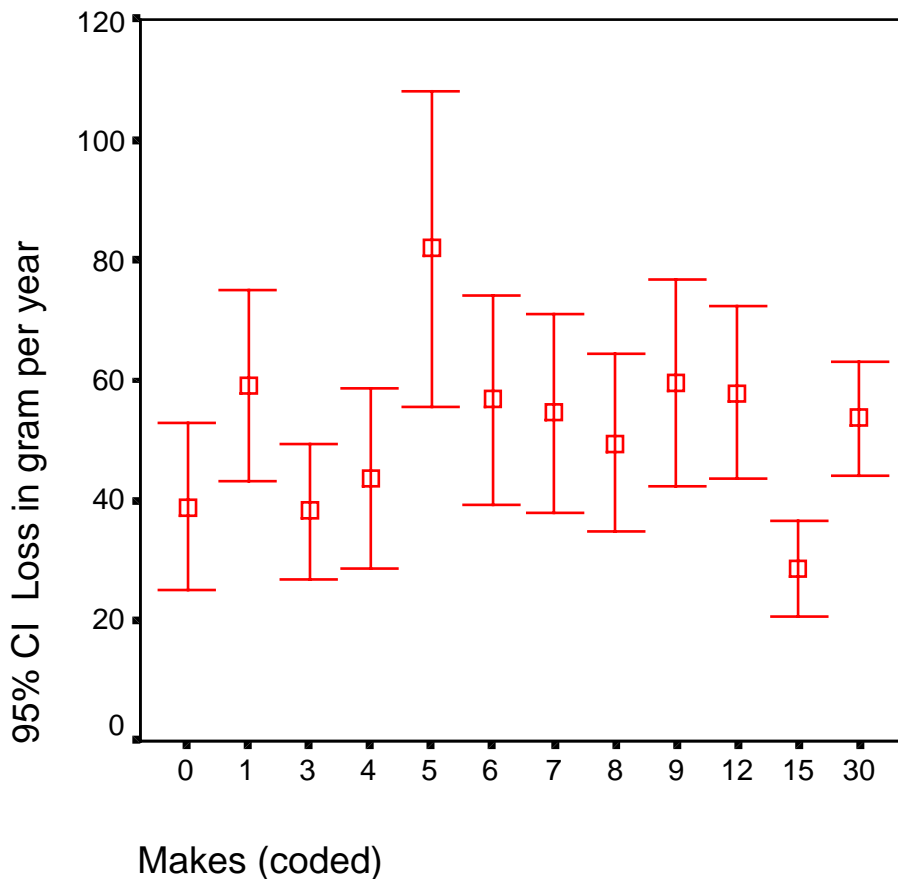

**Figure 12: Regular annual leakage rates by makes (coded). The 12 different makes or make-groups show significant differences from each other. Car manufacturer 15 has the lowest average annual leakage rate of 28.8 ( $\pm 5.3$ ) grams/yr, while car manufacturer 5 has the highest 81.9 ( $\pm 24.4$ ) grams/yr.**

While the average annual leakage rate was 52.4 grams/yr the MACs of several car manufacturers were higher than this figure. The highest was 81.9 grams. Car manufacturer “5” had an annual leakage rate that was estimated to be 60% higher than the average, or three times higher than the best performer (car manufacturer “15”). It seems evident that the design and quality of components used by manufacturers differ a lot and consequently the leakage of HFC-134a vary considerably.

Some further analysis was carried out to establish whether some anomaly would explain the high or low leakage rates of e.g. manufacturer “5” or “15” but none was found. It seems that the design of the systems and the components used is the most likely explanation.

| Make     | 0     | 1     | 3     | 4     | 5     | 6     | 7     | 8     | 9     | 12    | 15   | 30   |
|----------|-------|-------|-------|-------|-------|-------|-------|-------|-------|-------|------|------|
| LR gram  | 39.9  | 59.1  | 38.2  | 43.7  | 81.9  | 56.8  | 54.5  | 49.5  | 59.4  | 58.0  | 28.8 | 53.7 |
| Err gram | ±13.1 | ±15.6 | ±10.9 | ±14.8 | ±24.4 | ±16.9 | ±15.6 | ±14.0 | ±16.7 | ±14.1 | ±6.9 | ±9.1 |
| LR %     | 6.2   | 7.9   | 5.8   | 5.9   | 10.6  | 7.3   | 6.4   | 5.9   | 7.0   | 7.6   | 5.3  | 7.0  |
| EB %     | ±2.1  | ±2.1  | ±1.8  | ±1.8  | ±3.0  | ±2.1  | ±1.8  | ±1.7  | ±1.9  | ±1.9  | ±1.3 | ±1.4 |
| Av. Age  | 45    | 32    | 42    | 32    | 43    | 48    | 48    | 53    | 37    | 42    | 41   | 39   |
| Charge   | 615   | 757   | 673   | 717   | 770   | 772   | 859   | 880   | 843   | 763   | 542  | 789  |

*Explanation:* Different makes behind the codes are Audi, BMW, Ford, Mercedes-Benz, Opel, Peugeot, Renault, Volkswagen, Volvo and the make groups "Other EU makes", "Japanese, made in Japan", and "Japanese, made in EU" – assigned to the code numbers in a random manner. The mean leakage rate was 52.4 grams or 6.9% per annum.

### V.6 Average annual leakage rates by MAC properties

In the Contact Group of this project it was suggested to ascertain from each MAC that would be measured selected properties and to test their influence over the size of the annual regular leakage rate. Besides of the MACs' charges itself the way of the refrigerant expansion (by orifice tube or expansion valve) as well as the control of the MAC (manually or automatically) should be looked at for possible differences. The results are presented in Table 14.

| Property<br><i>Number</i> | MAC Charge     |                | Expansion     |            | MAC Control |               |
|---------------------------|----------------|----------------|---------------|------------|-------------|---------------|
|                           | < 756 g<br>176 | > 756 g<br>100 | Orifice<br>66 | EXV<br>210 | Autom<br>73 | Manual<br>203 |
| Leakage rate grams/y      | 44.2           | 66.9           | 49.3          | 53.4       | 51.3        | 52.8          |
| Error band grams          | ±4.5           | ±9.3           | ±7.6          | ±5.6       | ±8.4        | ±5.5          |
| Leakage rate percent      | 6.5            | 7.7            | 6.7           | 7.0        | 6.3         | 7.1           |
| Error band percent        | ±0.7           | ±1.1           | ±1.1          | ±0.7       | ±1.0        | ±0.7          |
| Av. Age in months         | 40             | 42             | 37            | 42         | 40          | 41            |
| Av. Charge grams          | 684            | 883            | 743           | 760        | 806         | 738           |

The leakage rate of systems with orifice tubes is somewhat lower with 49.3 grams/y compared to 53.4 grams/y. However, as the error-band of the one figure overlaps with the other's, the difference is not statistically significant.

Similar is the difference between automatic and manual MAC control. MACs with manual control show a higher figure in grams/y (52.8 to 51.3), and a higher figure in percent (7.1 to 6.3). However, statistics forbid the conclusion, that automatic controls lead to more leak-tight systems.

The average MAC charge of the sample is 756 grams. Dividing the MACs in a group charged below the mean (averaging 684 grams) and a group charged above it (averaging 883 grams), the leakage rate in grams/y of the smaller MACs becomes 44.2 (±4.5), and of the larger MACs 66.9 (±9.3). The result is statistically significant.

Large-sized MACs lose more refrigerant both in absolute and in relative terms than smaller systems. This may be a result of larger MACs being used in larger cars, which need longer lines and thus more connections<sup>15</sup>. Some experts fear that the growing number of Sport Utility Vehicles (SUV) and minivans, which are often equipped with two evaporators. The share of MACs in SUVs and minivans is under-represented in the sample. As the market share of these types of vehicles is likely to grow in the EU, the results of this study are likely to underestimate the likely leak rates of MACs in passenger vehicles up to 2010.

### V.7 Average annual leakage rates by selected vehicle properties

Contact Group experts suggested that the effect of additional specific characteristics of the vehicles would be analysed. For example, they asked whether the fuel type has an influence on the leakage rate. This could take place because diesel was assumed to generate less heat under the hood than the use of petrol does, and the extent of heat might influence on the refrigerant pressure and leaking. A second question was the capacity of the engine as indicator of its size: would larger-sized engines trigger higher refrigerant loss?

| Range                       | Engine Size            |                        | Engine Fuel |             |
|-----------------------------|------------------------|------------------------|-------------|-------------|
|                             | < 1940 cm <sup>3</sup> | > 1940 cm <sup>3</sup> | Diesel      | Petrol      |
| <i>Number</i>               | 165                    | 111                    | 70          | 206         |
| <b>Leakage rate grams/y</b> | <b>47.7</b>            | <b>59.4</b>            | <b>51.5</b> | <b>52.7</b> |
| Error band grams            | ±5.6                   | ±8.1                   | ±9.2        | ±5.3        |
| <b>Leakage rate percent</b> | <b>6.6</b>             | <b>7.3</b>             | <b>7.0</b>  | <b>6.9</b>  |
| Error band percent          | ±0.7                   | ±1.0                   | ±1.2        | ±0.7        |
| <i>Av. Age in months</i>    | 41                     | 41                     | 38          | 42          |
| <i>Av. Charge grams</i>     | 716                    | 815                    | 739         | 762         |

The engine (fuel) type does not seem to influence on the leakage rate (Table 15). The average annual leakage rate in case of diesel is 51.5 grams per year, compared to 52.7 grams per year in case of petrol. The difference in numbers is very small, and looking at the relative leakage rates petrol cars even show almost the same percentage.

Regarding the engine size, whose sample mean is 1940 cm<sup>3</sup>, the differences between the leakage rates of cars with engines less than 1940 cm<sup>3</sup> and cars with bigger engines seem to be considerable. However, as the refrigerant charges are different smaller engines show a leakage rate in percentage of 6.6% compared to the 7.3% of the bigger-motorized cars. The difference is small and not statistically significant.

The influence of the kilometres driven per year seems to be small, too (Table 16).

<sup>15</sup> However, only 2 out of the 99 large MACs had two evaporators requiring over 1,000 grams of HFC-134a. Thus, the difference in leak rates is not driven by dual evaporator MACs.



|                             | <b>Kilometres per year</b> |                    |
|-----------------------------|----------------------------|--------------------|
| <b>Range</b>                | <b>&lt; 20,853</b>         | <b>&gt; 20,853</b> |
| <i>Number</i>               | 170                        | 106                |
| <b>Leakage rate grams/y</b> | <b>50.9</b>                | <b>54.8</b>        |
| Error band grams            | ±6.0                       | ±7.3               |
| <b>Leakage rate percent</b> | <b>6.7</b>                 | <b>7.3</b>         |
| Error band percent          | ±0.8                       | ±0.9               |
| <i>Av. Age in months</i>    | 44                         | 36                 |
| <i>Av. Charge grams</i>     | 754                        | 759                |

### V.8 Average annual leakage rates by selected measurement conditions

In order to ensure that unidentified experimental artefacts did not influence the results, the possible influence the measurement conditions on the height of the leakage rate was established (Table 17).

The duration of the recovery cycle (ranging from 15 to 45 minutes, with a mean of 25.5 minutes) had no significant impact on the leakage rate measured. Taking less than 26 minutes time (138 out of the 276 cases), the leakage rate was a little higher both in grams and in percent. When recovering longer than 26 minutes, the leakage rates assessed were a bit lower, but the differences are statistically not significant.

Naturally, the duration of the recovery has real influence on the assessed leakage rate, simply because a minimum time needs to be taken to achieve sufficient recovery. However, smaller-charged MACs do not need as long time to be emptied as bigger-charged MACs do.

|                             | <b>Duration of recovery</b> |                    | <b>Ambient temperature</b> |                   |
|-----------------------------|-----------------------------|--------------------|----------------------------|-------------------|
| <b>Range</b>                | <b>&lt; 26 min</b>          | <b>&gt; 26 min</b> | <b>&lt; 15 °C</b>          | <b>&gt; 15 °C</b> |
| <i>Number</i>               | 138                         | 138                | 117                        | 159               |
| <b>Leakage rate grams/y</b> | <b>52.7</b>                 | <b>52.0</b>        | <b>54.7</b>                | <b>50.7</b>       |
| Error band grams            | ±6.6                        | ±6.5               | ±6.6                       | ±6.3              |
| <b>Leakage rate percent</b> | <b>7.2</b>                  | <b>6.6</b>         | <b>7.3</b>                 | <b>6.6</b>        |
| Error band percent          | ±0.9                        | ±0.8               | ±0.8                       | ±0.8              |
| <i>Av. Age in months</i>    | 40                          | 42                 | 43                         | 39                |
| <i>Av. Charge grams</i>     | 734                         | 777                | 746                        | 764               |

The ambient temperature is also a determinant of the recovery achievable. Low temperatures can be compensated by longer recovery time only to a certain extent. Therefore, ambient temperatures below 10 °C were tried to avoid, but that was not always realised. Sometimes, early in the morning the ambient temperature was just 6 °C. The real range was from 6 °C to 18 °C, with a mean of 15 °C. Recoveries carried out at temperatures below the mean show leakage rates (in absolute and relative terms) higher than when conducted in warmer ambient air. A higher leakage rate could indicate, that the recovery was insufficient, and by that the difference to the norm fill were overstated. However, in terms of statistical significance it is not adequate to draw this conclusion.

## V.9 Weighting the averages with car make and age

As shown in chapter III the composition of the sample of measured vehicles with MACs deviates from the population of the MAC-equipped EU car-fleet regarding age as well as makes.

The makes show different leakage rates, but some makes are over- and other makes are under-represented. The share of German and Swedish makes in the sample was larger than their share in the EU fleet. Conversely, the share of French and Italian makes is too small.

To correct the sample to the actual EU wide fleet the sample needs to be weighted with the factors that were established in table 4 (column 5), for all makes the real shares of MAC cars in the EU car fleet. Table 2 (column 3), contains the numbers, and implicitly shares, of the individual makes in the sample. They are copied to table 18 (columns 2 and 3).

| <b>Table 18: Deduction of the make weighting factors. Ratios between market share in EU fleet and share in sample</b> |                                       |                                |                                |
|-----------------------------------------------------------------------------------------------------------------------|---------------------------------------|--------------------------------|--------------------------------|
| 1. Make                                                                                                               | 2. Market share of MAC cars 96-01 (%) | 3. Share in sample (%) (N=276) | 4. Weighting factors (2) / (3) |
| BMW                                                                                                                   | 4.7                                   | 6.2                            | 0.8                            |
| Chrysler                                                                                                              | 0.8                                   | 0.4                            | 2.1                            |
| Mercedes                                                                                                              | 6.5                                   | 6.2                            | 1.1                            |
| Fiat (+Alfa, Lancia)                                                                                                  | 7.9                                   | 1.8                            | 4.3                            |
| Ford                                                                                                                  | 9.9                                   | 9.4                            | 1.0                            |
| Volvo                                                                                                                 | 2.2                                   | 9.8                            | 0.2                            |
| Opel/Vauxhall                                                                                                         | 11.2                                  | 12.3                           | 0.9                            |
| Saab                                                                                                                  | 0.8                                   | 3.3                            | 0.2                            |
| Citroen                                                                                                               | 4.5                                   | 1.4                            | 3.1                            |
| Peugeot                                                                                                               | 6.5                                   | 5.4                            | 1.2                            |
| Renault                                                                                                               | 9.8                                   | 9.8                            | 1.0                            |
| Audi                                                                                                                  | 5.2                                   | 9.8                            | 0.5                            |
| SEAT                                                                                                                  | 2.5                                   | 1.4                            | 1.8                            |
| Skoda                                                                                                                 | 0.9                                   | 0.4                            | 2.6                            |
| Volkswagen                                                                                                            | 11.2                                  | 13.0                           | 0.9                            |
| Honda                                                                                                                 | 1.0                                   | 1.8                            | 0.5                            |
| Mazda                                                                                                                 | 1.3                                   | 0.4                            | 3.6                            |
| Mitsubishi                                                                                                            | 1.2                                   | 2.2                            | 0.5                            |
| Nissan                                                                                                                | 2.8                                   | 1.8                            | 1.5                            |
| Suzuki                                                                                                                | 0.5                                   | 1.1                            | 0.5                            |
| Toyota                                                                                                                | 2.2                                   | 2.2                            | 1.0                            |
| Others                                                                                                                | 6.2                                   | 0.0                            | -                              |
| <b>Total 96-01</b>                                                                                                    | <b>100.0</b>                          | <b>100</b>                     |                                |

By dividing column 2 by column 3 gives the weights in column 4. With these weights an average leakage rate can be estimated to be consistent with the actual make shares in the MAC-equipped EU fleet 1996-2001 (Figure 13 and Table 19).

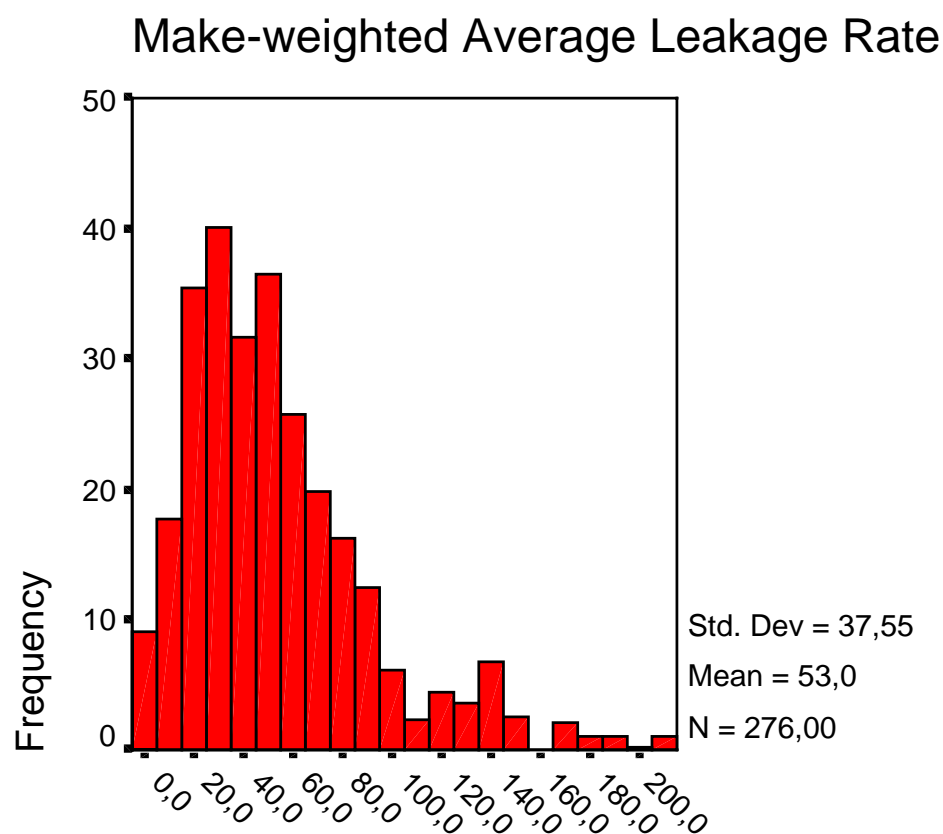

### Loss in grams per year

Cases weighted by real EU make shares

**Figure 13: The 276 regular annual leakage rates in 20-gram-sections, by frequency and weighted by real make shares. The average of the scattered leakage rates amounts to 53.0 grams, 0.6 grams more than in case of the un-weighted leakage rate.**

The make-weighted average leakage rate is 53.0 grams per year and by that 0.6 grams higher than the un-weighted leakage rate shown before. As percentage of the norm charge the weighted leakage rate amounts to 7.1 instead of 6.9 percent before.

| <b>Table 19: Annual Make-Weighted Leakage Rate in Grams and as a Percentage of the Norm Charge</b> |         |      |            |      |
|----------------------------------------------------------------------------------------------------|---------|------|------------|------|
|                                                                                                    | Valid N | Mean | Std. Error | 2 SE |
| Grams                                                                                              | 276     | 53.4 | 2.26       | ±4.5 |
| Percent                                                                                            | 276     | 7.1  | 0.29       | ±0.6 |

Table 20 gives other make-weighted means of the data.

| <b>Table 20: Other make-weighted means of the data</b> |                       |                      |           |
|--------------------------------------------------------|-----------------------|----------------------|-----------|
| Norm charge per MAC                                    | 747 grams             | Annual mileage       | 20,456 km |
| Age of the MACs                                        | 42.6 months           | Mileage              | 68,318 km |
| Cubic capacity of engine                               | 1,859 cm <sup>3</sup> | Duration of recovery | 24.6 min  |

Alternatively to weighting the sample leakage rate by the real make composition the real age-structure of the MAC equipped car fleet might serve as a corrective of the leakage rate. The deviation of the sample's age-composition from the real shares of the single age-groups in the fleet was especially high at the first year, i.e. the 12 to 23 months old cars. Instead of 23.5% only 18% of the cars of the sample were represented in this age-category. In the following table the sample's age composition is adjusted to the real age composition.

**Table 21: The age-weighted annual average leakage rate**

| 1. Age | 2. Number in sample | 3. Percent of sample | 4. Leakage Rate in grams/y | 5. MAC population | 6. Percentage of MAC population | 7. Weight | 8. Weighted average Leakage Rates g/y |
|--------|---------------------|----------------------|----------------------------|-------------------|---------------------------------|-----------|---------------------------------------|
| 1      | 50                  | 18.1                 | 80.3                       | 9,076,570         | 23.5                            | 1.30      | 104.2                                 |
| 2      | 65                  | 23.6                 | 50.7                       | 8,123,048         | 21.0                            | 0.89      | 45.3                                  |
| 3      | 66                  | 23.9                 | 49.6                       | 7,381,673         | 19.1                            | 0.80      | 39.7                                  |
| 4      | 45                  | 16.3                 | 40.6                       | 5,905,604         | 15.3                            | 0.94      | 38.1                                  |
| 5      | 29                  | 10.5                 | 39.8                       | 4,595,898         | 11.9                            | 1.13      | 45.1                                  |
| 6      | 21                  | 7.6                  | 42.6                       | 3,517,660         | 9.1                             | 1.20      | 51.0                                  |
|        | 276                 | 100                  | 51.4                       | 38,600,453        | 100                             | 1.0       | <b>53.9</b>                           |

The age-weighted average leakage rate is derived as follows. Column 2 of Table 21 contains the cases of the corrected sample by age-groups (column 1), ranging from 21 to 66. The numbers are changed to percentages of the total 276 in column 3. In column 4 are the leakage rates by years according to Table 11. The fifth column contains the real MAC population by years, given by Global Insight for the seven major EU countries as proxy for the total EU-15. In the sixth column this population is expressed as percentages of the total of the six years. The column 7 shows the weighting factors as numbers expressing the relation of each population percentage (6) to the respective sample percentage (3). Finally, in the last column the weighted annual leakage rates are shown, resulting from multiplying the sample's leakage rates (4) with the weights in column 7. The last row of column 8 contains the mean of the six different age-weighted leakage rates, 53.9 grams. The Standard Error is 2.4 grams, the error band is  $\pm 4.8$  grams. The annual age-weighted leakage rate in percent is  $7.1 \pm 0.6$ . The mean charge is 756 grams.

## V.10 Conclusions

In this study it has been established that the annual average leakage rate of regular emissions from “second generation” MACs in EU 15 ranges between 52.4 grams and 53.9 grams of HFC-134a per annum. The leakage rate does not seem to depend much on the climatic conditions, the type of fuel used or the type of engine. A surprising result was that the youngest MACs had the highest leakage rates (80.3 grams of HFC-134a per annum). This finding seems to warrant further study.

It was also established that the leakage rate of the worst performing car manufacturer (with a leakage rate of 81.9 grams of HFC-134a per annum) was three times higher than the leakage rate of the best performer (28.8 grams of HFC-134a per annum). This seems to indicate that there is ample room for improvement by improving the MAC design and in particular by acquiring quality parts by the car manufacturers.

The results of this study need to be compared with the other HFC-134a emissions that occur during the lifetime of the air conditioner. These emissions are (i) before taking the car into use, (ii) “irregular” emissions due to accidents, stone hits, component failures, (iii) emissions during service and (iv) emissions at the end of life of the vehicle. Öko-Recherche (2001) was estimated that these “irregular” losses were about 16.3 grams per annum. Adding the “regular” and “irregular” emissions and assuming that the expected lifetime of a vehicle is 14 years, the expected greenhouse gas emission from a mobile air conditioner of an average in the EU is about 1,3 tonnes<sup>16</sup> of CO<sub>2</sub> equivalent over the lifetime.

These emissions need to be complemented by HFC-134a emissions before the vehicle has been taken into use, the service emissions and the end-of-life emissions, as well as CO<sub>2</sub> emissions due to the increased fuel consumption as a consequence of operating the air conditioner. In conclusion, while “regular” HFC-134a emissions are likely to be the single most important source of greenhouse gas emissions from mobile air conditioners, it is important to estimate the amount of other HFC-134a and CO<sub>2</sub> emissions to understand the full climatic impact of mobile air conditioners.

---

<sup>16</sup>  $(53+16.3)*14*0.013=1.3$

## Annex I Measurement Protocol

### Measurement Protocol for the Establishment of Leakage Rates of Mobile Air Conditioners: How to operate recovery stations to determine MAC refrigerant charges

#### I. Introduction

All types of commercially available recovery stations can be used to measure the actual refrigerant level of a MAC, at least in principle.

Simple manually operated devices are equivalent to automatic machines for this purpose. Modern stations with built-in scales displaying changes in the tank's weight digitally are superior to units with simple transparent cylinders for measuring by sight. However, this applies to the accuracy of the filling operation only, not of recovery.

This is the reason why it cannot be taken for granted that the increment in the tank's weight exactly equals to the refrigerant quantity sucked into the recovery station. Mass shifts (liquid/gaseous) in the station's piping, especially in the condenser, cannot be excluded. In other words, it is possible that the refrigerant does not completely reach the reservoir tank.

Technical modifications have been suggested, to raise the measurement accuracy. These were connecting the condenser to the weighing bottle and separating the condenser fan from the condenser itself (to stop distorting vibrations). However, such modifications were not seen sufficient as certain parts of refrigerant still could be held back in the piping, in the dryer or in the compressor. Given these problems a more efficient way to increase measurement accuracy was developed for the leakage rate studies commissioned by the European Commission (EC) and the Dutch Energy and Environment Agency (NOVEM) (hereafter referred as EC/NOVEM study). Below this measurement protocol is described in detail as it is recommended for any following tests.

Its essential feature is the use of external scales with high resolution to put the whole recovery station onto a load platform before and after each suction operation. By using an external scale the refrigerant distribution within the recovery station can be ignored.

Further advantages of applying external scales instead of modifying recovery stations are (1) the higher degree of reproducibility due to the high accuracy of the external scales compared with the effect of mechanical manipulations inside a recovery station, (2) the possibility to use simple recovery stations without built-in scales, and (3) the possibility to utilize the long phase of automatic recovery for connecting one or two more commercial recovery stations to MACs, at the same time. In this way double (or even triple) the number of measurements per day can be achieved.

It is also important not to forget that some oil could be entrained by the refrigerant during the suction extraction. This oil may be collected in the station's oil-separator.

In order to measure the amount of refrigerant recovered accurately, this oil has to be drained off after every recovery cycle.

It is self-evident that the highest accuracy of weighing the refrigerant extracted would be useless if after the recovery a considerable and furthermore unknown refrigerant fraction would still remain un-extracted in the MAC itself. It is not possible to complete recover all refrigerant in practice. However, the method used for the EC/NOVEM measurements has proved to be capable of reducing that un-extracted remainder to a size which is not only small but which also keeps within narrow and well-defined limits of from some 10 to some 30 grams. The measurement method was tested in two completely new cars (out of factory line). The exact filling of these cars were known. With the EC/NOVEM measurement protocol, in the first case 10 grams were left to the system, and in the second case 30 grams were left.

Below, this method is described in all its individual stages as accurately as possible. The reason for that detailed protocol is not only to explain the confidence level of our measurement results but also to present uniform and clear rules for future measurements wherever they might be carried out.

It goes without saying that the person performing such measurements must be a well-trained and experienced technician.

## II. The measurement equipment used

Apart from some 20 measurements all other ones (420) of the EC/NOVEM study were carried out with two similar relatively simple recovery stations. They were used simultaneously, and the performance of both stations was the same. The stations were:

1. RHS 500 WAECO – A'GRAMKOW 134a
2. RHS 650 WAECO – A'GRAMKOW 134a

### II.1 Specifications of the recovery stations

Both models are equipped with internal refrigerant cylinders of 4 kg capacity. The current refrigerant level can be read off by sight glass.

At both stations the two service hoses are connected, the blue one (72") for the low pressure and the red one (72") for the high pressure, each with a standard length of 180 cm. On the instrument panel two shut-off valves can be operated: the low-pressure valve and the high-pressure valve. Five different on/off switches can be used, apart from the main switch there is one for "Recovery", "Recycling", "Evacuation", "Recharging". Three pressure gauges are displayed on the instrument board of the RHS 650: Vacuum gauge, high-pressure gauge, and low-pressure gauge. The RHS 500, which is a "light" version of the RHS 650 with the same basic functions, has no display for the evacuation. At both stations special valve-controlled oil-injectors are fitted to the outlet of the high-pressure hose (by means of a special adaptor) to add refrigerant oil to the hose while it is in a vacuum.

The weight of the RHS 500 is 58 kg, the weight of the RHS 650 is 77 kg. The voltage is in both cases 220V and 50 Hz, allowing the use of usual cables and plugs.

### II.2 Specification of the scales

The surface plate of the load platform is made of steel for a maximum load-bearing capacity of 120 kg. Its dimensions are 800 x 600 mm. The load cell (the analogue to digital converter of load to electrical signals) facilitates a weight resolution of 10 grams, and the weight can be read off a LCD display. The voltage for the scales is 220 V - 50 Hz. The scale is a special making up of the German company "Waagen Krug" for the purpose of the study. Commercially available scales of the same resolution and load-bearing capacity cost about 4.000 Euro.

The scale is regularly tested by means of calibrated weights of 10,000 grams (10 kg). This was also done before and after every measurement cycle in October 2002, November 2002, December 2002 and January 2003. In the course of the EC/NOVEM project deviations did not occur, given the 10-grams-resolution.





**Figure 14:** A recovery station Waeco RHS 650 on the scale before and after the recovery operation.

The picture was taken during the EC leakage rate measurement programme in 2002 in Helsingborg, Sweden

### **III. Fourteen individual steps of the measurement cycle**

The first measurement requirement is a sufficiently long resting time of the cars to be tested. Neither the engine nor the compressor should run 24 hours before the recovery begins otherwise the refrigerant extraction is seriously impeded as more refrigerant is held dissolved in the lubricating oil.<sup>17</sup> Thus, it is advisable to work in garages that have a sufficiently large number of used cars.

Before starting the technician should check that the cars fit into the selected mix of make and age and whether basic information on the vehicles (like first registration date, etc) is accessible to him. If this is not the case, the technician should not unload and install his measurement equipment in vain.

#### **III. 1. Weighing the recovery station**

The recovery station, its hoses and oil separator must be empty before weighing. All these are weighed as a whole on a dedicated load platform with resolution of 10 grams at least. The displayed weight of the empty system needs to be written down (e.g. 77.88 kg).

#### **III. 2. Visual check of the MAC**

The recovery station is brought to the selected vehicle. The technician should first make a visual control to establish whether the AC shows a mechanical damage or

---

<sup>17</sup> By the way, that the car keys are not needed to start up the engine in the course of the measurements but only to open doors and hoods is good for the garage's operator's cooperation.

any indications of previous repair. If so, this MAC should not be measured, if the test is to measure "regular" leaks. In the EC/NOVEM study such MACs were not measured.

### **III. 3. Connecting hoses to the MAC**

The protection caps are removed from the MAC service ports and the quick fitting pipe union of the [blue] low-pressure hose is attached to the low-pressure service port while the pipe union of the [red] high-pressure hose is joined to the high-pressure service port of the MAC. To avoid any confusion the low-pressure service port is smaller than the high-pressure port.

In cases only one service connection exists on the high-pressure side (this is true to all but one Audi model), only the high-pressure hose is connected to. In case the only service port exists on the low-pressure side (some Volvo and Saab models), only the low-pressure hose is joined. (Doing without two service ports and by that saving a potential source of refrigerant loss is only possible if the MAC uses an orifice tube instead of an expansion valve. The latter may get blocked and because of that disable extraction from one point only, while the first is always open to let refrigerant pass through).

### **III. 4. MAC pressure check**

The valves of the service connections are opened by manually turning the cock of the unions, and immediately the MAC's low pressure (suction pressure) and high pressure (liquefying pressure) readings are displayed on the station's pressure gauges provided. (If only one service port is joined, only one gauge works, of course). Both gauge dial values (in the case of two ports) should be alike as the different pressures have evened out inside switched-off AC systems, and the values should range between 4 and 6 bar (absolute) corresponding to ambient temperature of from 10 °C to 20 °C as long as there is a minimum (at least about 50 grams) of refrigerant inside the system. Thus, the pressure gauges provide the next indication of the system's condition. If no pressure at all is displayed the MAC is obviously empty and a hidden mechanical leak is very likely. Such vehicles were ruled out from further measuring, too.

### **III. 5. Switching on recovery**

By turning the recovery station on "recovery" the compressor starts suctioning and draws the refrigerant in as long as its own suction pressure is lower than the pressure inside the MAC. The pre-set working low-pressure of all the stations applied in the course of the EC/NOVEM measurements was 0.7 bar absolute. The refrigerant from both the high-pressure side and the low-pressure side of the MAC passes over a single main line leading inside the recovery station, flowing eventually into a reservoir tank (bottle, cylinder). The oil-separator near to the station's inlet holds back any entrained refrigerant oil.

### **III. 6. Running the suction operation**

The recovery station's compressor (mostly) automatically switches off at 0.7 bar absolute (equalling – 0.3 bar relative to normal pressure) and switches on again at a pressure by from 0.5 to 1.0 bar higher when the pressure has increased by after-evaporating refrigerant which may have been dissolved in oil, or was not immediately withdrawn from the lower parts of the refrigerant circuit. The pre-set value to cause renewed recovery was 1.3 bar absolute at all the stations used for the EC/NOVEM measurements. The extraction process starts again on any renewed rise in pressure in the AC system above 1.3 bar absolute and continues with the recovery. The entire recovery process is not finished before a rise in pressure above 0.7 bar no longer occurs over five minutes. Thus, the entire extraction lasts at least 20 minutes, in case of orifice tubes five minutes more should be given.

Comment: As the suction operation of the recovery station runs automatically, the technician can use the time either to start a second measuring cycle at another car (on condition a second station is available) or he can collect and note down the basic and possibly additional data on the vehicle as requested by the project. It suggests itself to use a special reporting form to fill the data in to prevent any data from being forgotten. (The data reporting form used for the EC/NOVEM project is presented at the end of this chapter).

### **III. 7. Detaching the hoses**

After the extraction the hoses must be detached from the MAC's service ports, whose valves get closed by that, locking up the AC system at an inside pressure of 0.7 bar absolute. The recovery station with its empty and also closed hoses is brought back to the weighing platform.

### **III. 8. Draining off the oil**

To avoid falsified measuring results, before weighing the recovery station which now contains the extracted refrigerant, the oil separator must be drained off. Usually the little amount of oil, if any at all, can be captured manually in a measuring cup which allows to determine the quantity to give back the same volume of (fresh) oil to the MAC, later. Of course, the automatic way of draining off the oil is equally good.

### **III. 9. Second weighing**

The recovery station is now weighed a second time on the load platform, and the new weight must be noted down. It depends on the setting, whether the total weight of the recovery station or only the increment in weight since the first weighing is displayed by the dial. Both versions are basically equivalent. But when using more than one recovery station, it is not recommended to zero the scales to avoid mixing up the one with the other recovery station's weight. At any rate, the weight's difference against the first weighing is the objective of the whole exercise.

### III. 10. Back to the vehicle to recharge the MAC

To refill the MAC system to the norm charge <sup>18</sup> the technician needs to move the recovery station a second time to the vehicle. This time only one hose needs to be attached. Apart from the rare cases of the only service port being on the low-pressure side upstream of the accumulator, which has to be big enough to hold the total liquid refrigerant charge, the service port in question is generally the connection on the high-pressure side and so it is the high-pressure hose to be coupled up for filling. The quick-fitting pipe union of the hose should be attached but not yet opened, before the desired refrigerant quantity is not released into the hose.

### III. 11. Adding the oil

Before releasing the refrigerant norm charge out of the reservoir tank, fresh oil of the same amount as extracted and captured before, must be given into the filling hose, automatically or manually. One elegant way of manual addition is a short (up to 3 minutes lasting) evacuation of the filling hose which is still locked at both of its ends. The then extremely low pressure inside the hose allows it to fill in the oil easily with the help of an oil injector as its is used to transfer oil into a vacuum.

Comment: This is the only case the vacuum pump of the station is needed, quite differently from the usual practice when servicing a MAC including mechanical opening the MAC, leak detection and possible repair. For the limited purpose of just recovery and recharging a MAC, the removal of non-condensable gases by running the evacuation process is not necessary.

### III. 12. Recharging refrigerant

Modern recovery/recharging stations allow automatic adjustment of the required refrigerant quantity to flow from the station's liquid reservoir tank into the MAC system. This is done by entering the norm fill with the help of a keyboard on the station's instrument panel. By switching on "recharging" the charging valve gets opened and the defined quantity leaves the tank to flow into the filling hose, and through it into the MAC as soon as its service connection is opened.

Using simpler stations the required refrigerant quantity needs to be measured by eye. The technical difference to automatic machines is that the measuring is only possible together with recharging, not before that. The valve of the charging hose at the station must be opened as well as the service connection of the MAC. Then the fill level of the transparent reservoir tank falls as the tank contents flow out, so the amount of refrigerant discharged can be visually checked while recharging proceeds by reading off the measuring lines encompassing the transparent tank. The

---

<sup>18</sup> Of course, to top-up the MAC to the norm charge is no necessary step of a measurement cycle. But to offer that service to the garage's operator is a reward to increase his willingness to hand over the cars for leakage test . Usually, the norm fill can be read off from a label at the vehicle itself or, if there is no label, must be taken from one of some appropriate manuals available which should be part of the technician's reference material, in any case.

refrigerant flow must be stopped manually by closing the charging valve when the refrigerant level has decreased to the envisaged marking.

### **III. 13. Detaching and closing the hose**

After recharging, the quick-fitting pipe union of the filling hose must be detached and by doing so the hose's end as well as the service connection of the MAC get closed. The hose, which is not empty but still filled with refrigerant, can be taken off the vehicle, and the protection caps should be fitted over the service ports again.

### **III. 14. Emptying the hose**

Both in the automatic and the manual way of recharging the refrigerant flow is driven by the difference in pressure of initially 6 bar between reservoir tank and MAC system. The pressure in the MAC rises as the charging operation proceeds, which stops the hose and pressure-gauge fittings from being entirely emptied of refrigerant. Therefore the detached and at its end well-closed hose must be emptied by suction by turning on the "recovery", i.e. the compressor, again. This is a very important step, otherwise the next recovery cycle would be seriously distorted. Up to 50 grams of refrigerant may still remain in the hose depending on its length.

**IV. Decision tree for measuring a MACs charge using recovery stations**

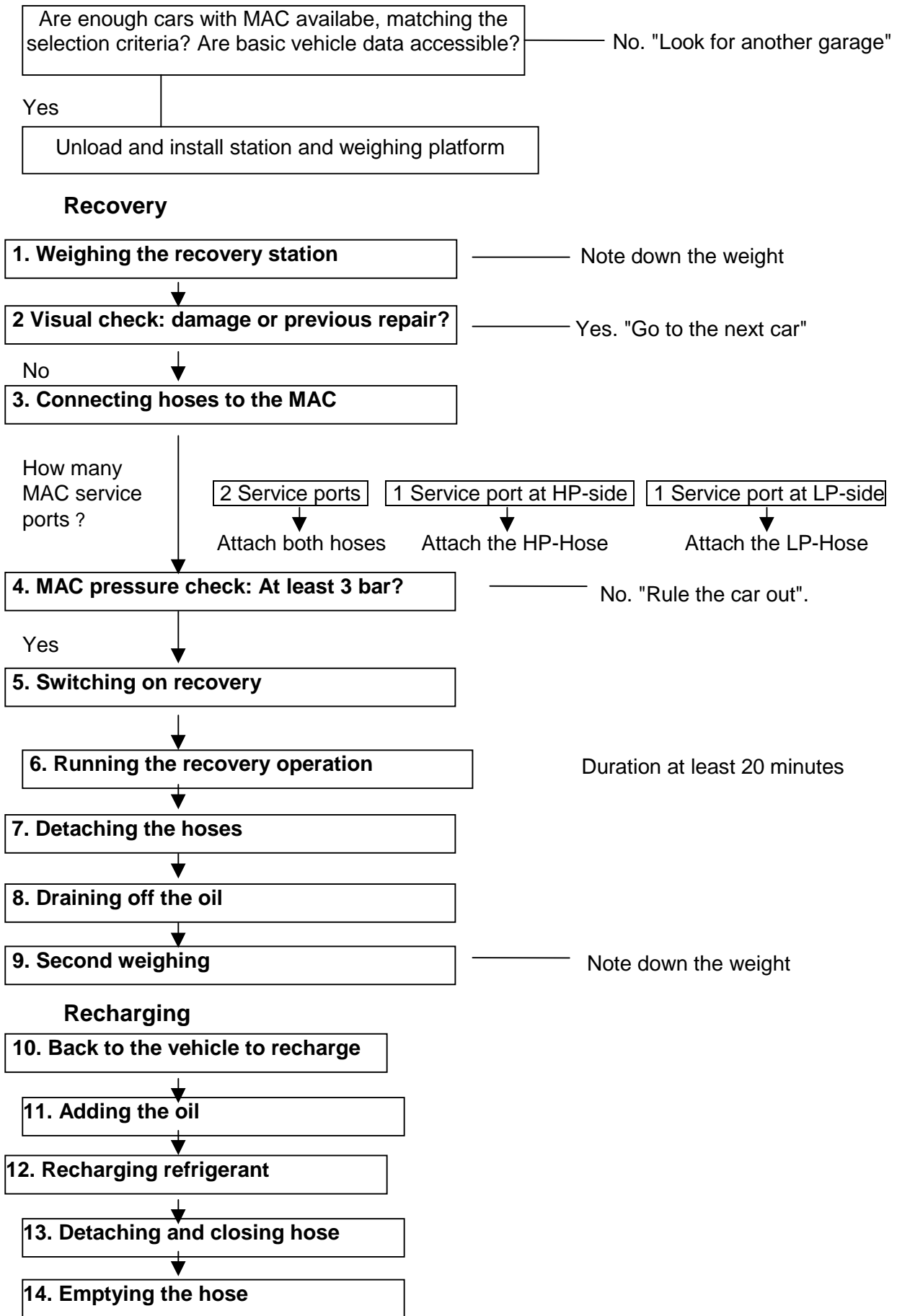

## **V. Further data to record in the context of a measurement**

The technician performs the measurements of the MAC's charge mainly by operating the recovery station. The final destination of the measurements is the establishment of a leakage rate and a better understanding of its influencing factors like age of the MAC, make and model of the car, climate conditions, mileage, engine power and that like but also of the circumstances of the measurements themselves.

Apart from the recovery of the MAC's refrigerant charge, following basic data must be reported at any rate. They are broken down into data on the vehicles and data on the measurement itself. As a minimum the following data must be gathered.

### V.1 Basic Data on Vehicle

1. Vehicle Identification Number (VIN)
2. Date of First Registration of the Car
3. Car Manufacturer
4. Vehicle Type and Model
5. Kilometres on Odometer
6. Norm Charge as labelled at the Vehicle  
(as far as it can be found out at the measurement place itself)

### V.2 Basic Data on Measurement

1. Place and Country of Measurement
2. Serial Number of Measurement
3. Date of Measurement
4. Time at Start and End of Measurement
5. Ambient Temperature during Measurement
6. Recovered Refrigerant in Grams

### V.3 Additional Data depending on Project-specific Questions

Depending on specific assumptions about the factors influencing the leakage rate additional data can be ascertained. As a result of discussions in the Contact Group to the EC leakage rate study following further data were collected and recorded:

1. Type of Fuel (Diesel or Petrol)
2. Cubic Capacity
3. Engine Power in kW
4. Expansion Device (Expansion Valve or Orifice Tube)
5. Control Type of MAC (Manual or Automatic)

Clearly, additional data are not so essential as basic vehicle and measurement data are. Of course, their presentation mirrors the specific questions of the EC leakage rate study. Any other study following the EC measuring approach as outlined above is free to add further questions or to drop any of the last five presented.

### V.4 Data Reporting Form

The Data Reporting Form as used at the EC/NOVEM measurements from October 2002 to January 2003 is presented overleaf.

**DATA REPORTING FORM FOR RECOVERY OF REFRIGERANT FROM MOBILE AIRCO**

**Background data**

- 1. Name of garage: .....
- 2. Date of measurement: ..... / ..... / 200.....
- 3. Identification number of measurement on specific day: .....

**Measurement data**

- 4. Manufacturer and model of recycling system\*:  RHS 550 /  RHS 650 /  RHS 1050
- 5. Ambient temperature during measurement: .....°C
- 6. Time at start and end of measurement:.....
- 7. How much refrigerant was recovered? ..... grams

**Vehicle data**

**Information collected at the vehicle**

- 8. Manufacturer and model of vehicle:.....
- 9. Vehicle Identification Number (VIN) (17 characters): .....
- 10. Type of engine\*:  DIESEL /  PETROL
- 11. Cubic capacity (piston displacement): ..... cm<sup>3</sup>
- 12. Kilometres on odometer: ..... km
- 13. Refrigerant expansion device\*:  EXPANSION VALVE /  ORIFICE TUBE
- 14. Control type of air conditioning system\*:  MANUAL /  AUTOMATIC

**\* Please tick one option!**

**Information collected from records if not available at the vehicle**

- 15. Engine Power: .....KW
- 16. First registration of vehicle (month / year) : ..... / .....
- 17. Prescribed nominal charge of HFC-134a (incl. tolerance band): ..... grams
- 18. Additional observations: .....

19. Signature of technician: .....



## Annex II Participating Garages

### List of the garages that participated in the measurement programme

#### 1. Germany (November 2002)

Deitert-Suhre GmbH & Co.KG  
Mr Ludwig Deitert  
Tecklenburger Damm 41-49  
D-49477 Ibbenbüren  
Phone 0049 5451 9494-0  
[info@deitert-suhre.de](mailto:info@deitert-suhre.de)

Deitert-Suhre GmbH & Co.KG  
Mr Rainer Budke  
Recker Strasse 23  
49497 Mettingen  
Phone 0049 5452 9337-0  
[info@deitert-suhre.de](mailto:info@deitert-suhre.de)

Autohaus Berkemeier GmbH  
Mr Berkemeier  
Ibbenbürener Str. 19  
48369 Saerbeck  
Phone 0049 2574 87 - 0

Autohaus Luft  
Mr Peter Fahrenholz  
Rudolf-Diesel-Str. 4-6  
65760 Eschborn  
Phone 0049 6173 9341 0  
Fax 0049 6173 63473

#### 2. Sweden (December 2002)

Bildeve  
Miljöchef Jan Martinsson  
Box 22042  
250 22 Helsingborg  
0046 42 172559  
[www.bildeve.se](http://www.bildeve.se)

Bilpartner  
Mr Klas Lindqvist  
Box 7074  
250 07 Helsingborg

Hedbergs Bil  
Servicechef Hans Holmqvist  
Ängelholmsvägen 1  
254 53 Helsingborg

Din Bil  
Mr Peter Jacobsson  
Box 22122  
250 23 Helsingborg

Toyota Center  
Servicechef Bengt Stolt  
Box 22055  
250 22 Helsingborg

Hedin Bil  
Servicechef Anders Matsson  
Box 22129  
250 23 Helsingborg  
Phone 0046 42 250900

### **3. Portugal (January 2003)**

Florescar Comércio de Automóveis, Ida.  
Eng. Nuno Luz,  
R. Dr. Artur Figueirôa, 100  
2500-187 Caldas da Rainha  
Phone 00351 262 840 513  
Fax 00351 262 840 518

Joachim José Ferreira da Silva, Ida.  
Sr Joachim José Ferreira da Silva  
Av. Dos Combatantes,  
2040-344 Rio Maior  
Phone 00351 243 99 2578  
Fax 00351 243 99 6486

Stand Rainha  
Sr Pedro Marto S. Martinho,  
Rua António Sergio-Lote 52.1º Esq.  
2500 Caldas da Rainha  
Phone 00351 262 990 709  
Fax 00351 262 990 766

João Luís Vicente, Ida.  
João Luís Vicente,  
Estrada Nacional Nº 3-Sítio Palhão,  
2070-621 Vila Chá de Ourique-Cartaxo  
Phone 00351 243 704 023  
Fax 00351 243 703 288

Jota Calado Comércio de Automóveis, Ida.  
Sr José João Calado-Gerente,  
Stand Sr<sup>a</sup> da Guia  
Vale de Estacas  
2000-65 Santarém  
Phone 00351 243 322 652  
Fax 00351 243 322 652

Nivelfor Ida  
D<sup>a</sup> Maria Sofia Silva  
Zona Industrial de Santarém  
Rua Conde de Ribeira Grande  
2000-831 Santarém  
Phone 00351 243 351 200  
Fax 00351 243 356 309

CAR 2000 Comércio de Veículos Automóveis, Ida.  
Sr Carlos Jorge Tavares-Sócio Gerente  
Av. Dos Combatantes  
2040-344 Rio Maior  
Phone/Fax 00351 243 995 357

Autosipe Comércio Automóvel Ida.  
Sr Luis Vitorino, Sócio Gerente  
Av. Dos Combatantes  
2040-344 Rio Maior  
Phone 00351 243 995 728  
Fax 00351 243 992 824

Roques Comércio de Veiculos e Serviços, Ida.  
Sr João Miguel  
Zona Industrial Av. Do Brasil  
2000 Santarém  
Tel 243 328 254  
Fax 00351 243 333 948

## Acknowledgements

Above all, we would like to thank Matti Vainio (DG Environment) on whose initiative this study was carried out. His ideas and suggested alterations have been taken on board almost without exception throughout the course of the project.

Special thanks to the active members of the Contact Group.

### The Contact Group

Baroto Adiprasito, Volkswagen AG, Wolfsburg, Germany  
Husamuddin Ahmadzai, Swedish EPA, Stockholm, Sweden,  
Redouane Benhmida, Valeo Climate Control, La Verrière Cedex, France  
Eva-Lotte Bernekorn Sandin, Swedish EPA, Stockholm, Sweden.  
Hanns-Peter Bietenbeck, Ford Werke AG, Koeln, Germany  
Tim Cowell, Delphi Automotive Systems, Bascharage, Luxembourg  
Bernd Dienhart, Visteon, Kerpen, Germany  
Hans Fernqvist, Volvo Car Corporation, Gothenburg, Sweden  
Eric Girot, Valeo Climate Control, La Verrière Cedex, France  
Dieter Heinle, Behr GmbH & Co., Stuttgart, Germany  
Guenter Koenigler, BMW Group, Muenchen, Germany  
Hans-Martin Lent-Philipps, ACEA, Brussels, Belgium  
Norman Mitchell, Refrigeration Air Conditioning & Electrical Engineers Refrigerant Recovery, Gloucester, UK  
Werner Mueller, ADAM OPEL AG, Ruesselsheim, Germany  
Jürgen Wertenbach, DaimlerChrysler AG, Stuttgart, Germany  
Karl-Heinz Zierock, DG Environment European Commission, Brussels, Belgium

Special debt of gratitude is due to:

Dietmar Boehme, Ford Werke AG, Koeln, Germany  
Franz-Josef Esch, Waeco International, Emsdetten, Germany  
Peter Fahrenholz, Autohaus Luft, Eschborn, Germany  
Arend Koppenol, NOVEM, Utrecht, The Netherlands  
Anders Lindborg, Ammonia Partnership AB, Viken, Sweden  
Heiner Pott, Waeco International, Emsdetten, Germany  
Jack Rushton, Rio Maior, Portugal  
David Smith-Tilley, Global Insight, London, UK

Last not least to

Thomas Borgert, m-tec, mobile Technik & mobiler Service, Ibbenbueren, Germany, who carried out all measurements in Germany, Portugal and Sweden.

## Literature

AFCE (Alliance Froid Climatisation Environment), Projection à 15 ans des émissions de HFC, Rapport d'étude par L. Palandre, D. Clodic, A.M. Pougin, mai 1998.  
Atkinson, W. and James A. Baker, Mobile Air Conditioning Systems and the Environment, May 2002.

- Baker, James A. (Delphi Automotive Systems, Inc): Mobile Air Conditioning: HFC-134a Emissions and Emission Reduction Strategies, in: Joint IPCC/TEAP Expert Meeting on Options for the Limitation of Emissions of HFCs and PFCs, Petten, 26-28 May 1999.
- Clodic, D., Ben Yahia, M. (Centre d'Énergétique, Ecole des Mines de Paris): New Test Bench for Measuring Leak Flow Rate of Mobile Air Conditioning Hoses and Fittings. Earth Technology Conference, Baltimore, 1997.
- Ecofys; Economic Evaluation of Emission Reductions of HFCs, PFCs and SF<sub>6</sub> in Europe; Special Report (Contribution to the study "Economic Evaluation of Sectoral Emission Reduction Objectives for Climate Change"); J. Harnisch and C. Hendriks, Commissioned by the Directorate General Environment of the European Commission, ECOFYS, Utrecht, 2000.
- IPCC 1999 = IPCC/OECD/IEA Programme for National Greenhouse Gas Inventories, Good Practice in Inventory Preparation for Industrial Processes and the New Gases, Draft Meeting Report Washington DC, United States, 26-28 January 1999.
- Kuhn, Peter et al., Carbon Dioxide R 744 as a Refrigerant in Automotive Air-conditioning Systems, ATZ worldwide 12/2001 Volume 101.
- Öko-Recherche, Emission of refrigerant R-134a from Mobile Air-Conditioning systems. Annual Rate of Emission from Passenger-Car Air-Conditioning Systems up to Seven Years Old, Commissioned by the German Environmental Protection Agency (Umweltbundesamt) Berlin, Frankfurt, September 2001.
- Öko-Recherche (Schwarz, W./Leisewitz, A.): Emissions and Reduction Potentials of HFCs, PFCs and SF<sub>6</sub> in Germany; For the German EPA, Berlin, October 1999.
- Pettersen, J./Hafner, A.: Energetischer Wirkungsgrad und TEWI von CO<sub>2</sub>-Fahrzeugen-Klimaanlagen, in: Reichelt, Johannes (Hrsg.): Fahrzeugklimatisierung mit natürlichen Kältemitteln, Heidelberg 1996, S. 64-77.
- Preisegger, Ewald (Solvay Fluor und Derivate GmbH): Automotive Air Conditioning Impact of Refrigerant on Global Warming, in: Joint IPCC/TEAP Expert Meeting on Options for the Limitation of Emissions of HFCs and PFCs, Petten, 26-28 May 1999.
- Reichelt, Johannes, From the air conditioning system to the heat pump in cars (in German), KI Luft- und Kältetechnik 3/2002, 136-139.
- Schwarz, Winfried, R 134a losses from car air-conditioning systems (in German), KI Luft- und Kältetechnik 2/2002, 78-80.
- Siegl, W. O. and T. J. Wallington, R-134a Emissions from Vehicles, ENVIRON. SCI. & TECHNOL., VOL. 36, issue 4, 561-566 (2002).
- Tujibayashi, Yoshiyuki (Nissan Motor Co., Ltd.), Action plan related to emission control of HFC134a refrigerant for automobile air-conditioning systems, in: Joint IPCC/TEAP Expert Meeting on Options for the Limitation of Emissions of HFCs and PFCs, Petten, 26-28 May 1999.
- UNEP-RTOC 1998 = UNEP 1998 Report of the Refrigeration, Air Conditioning and Heat Pumps Technical Options Committee, 1998 Assessment, Nairobi 1998.
- Vainio, Matti, A Billion Euro Question: How To Reduce Greenhouse Gases From Mobile Air Conditioners In The EU?, A paper to be presented at VDA Alternate Refrigerant Winter meeting Automotive Air Conditioning and Heat Pump Systems, 30-31 January 2002, Hotel Gut Brandlhof, Saalfelden, Austria.
- WAECO International GmbH: Refrigerant Charge Handbook - Filling Capacities, Emsdetten, 4/2000.